

PRODUCT GUIDE

BCE0015A

## Horizontal-Deflection Output Transistors

2003 semiconductor  
<http://www.semicon.toshiba.co.jp/eng>

# 1 Outline

Toshiba has developed a range of fifth-generation horizontal-deflection-output transistors (HV-Trs). Radical redesign of the emitter electrode and the contact pattern has yielded significant improvements, resulting in higher current density and superior electrical characteristics compared to those of fourth-generation products. Toshiba's propriety glass-mesa structure results in a high breakdown capability.

Thanks to Toshiba's wealth of experience and the wide variety of products which the company can offer, Toshiba horizontal-deflection-output transistors are used worldwide in color TVs and video display monitors.

# 2 Appearance, Package and Weight

The photographs below show the products and their markings. The packages shown are is the through-hole packages used for standard products.

## ● Appearance

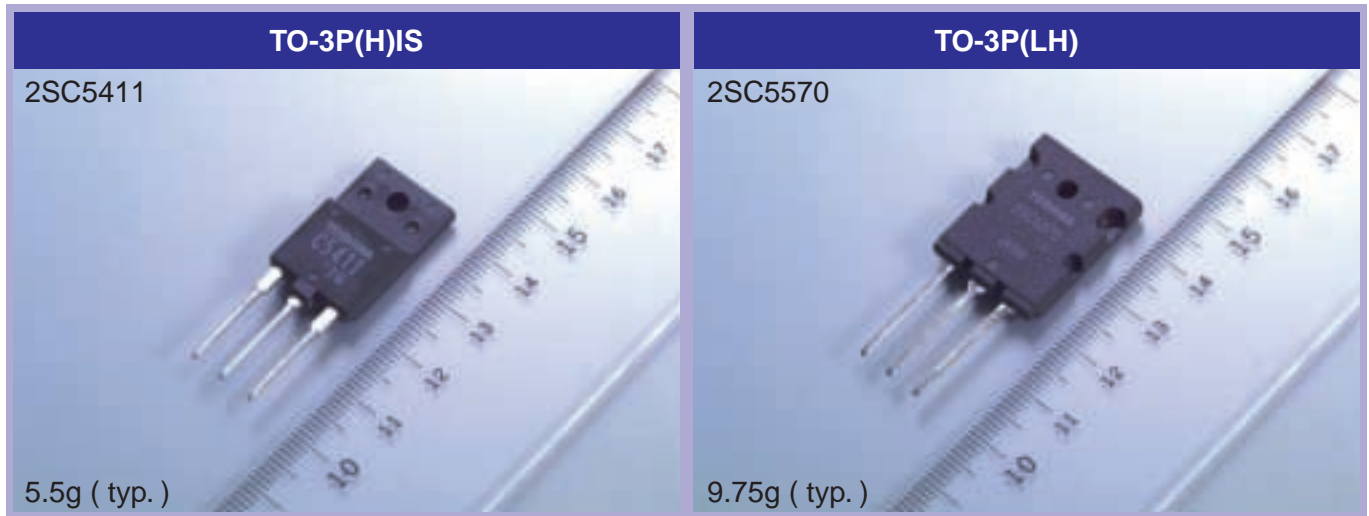

## ● Package dimensions

(Unit: mm)

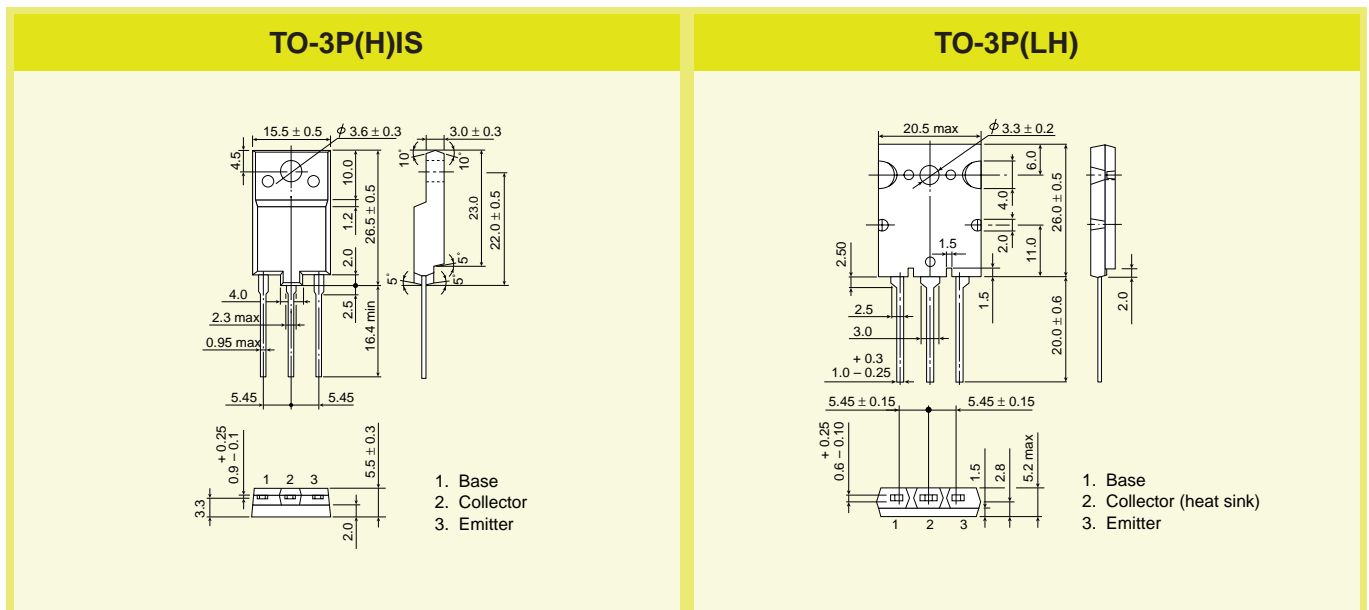

# 3 Device Trends

## Market trends and the development of horizontal-deflection output transistors

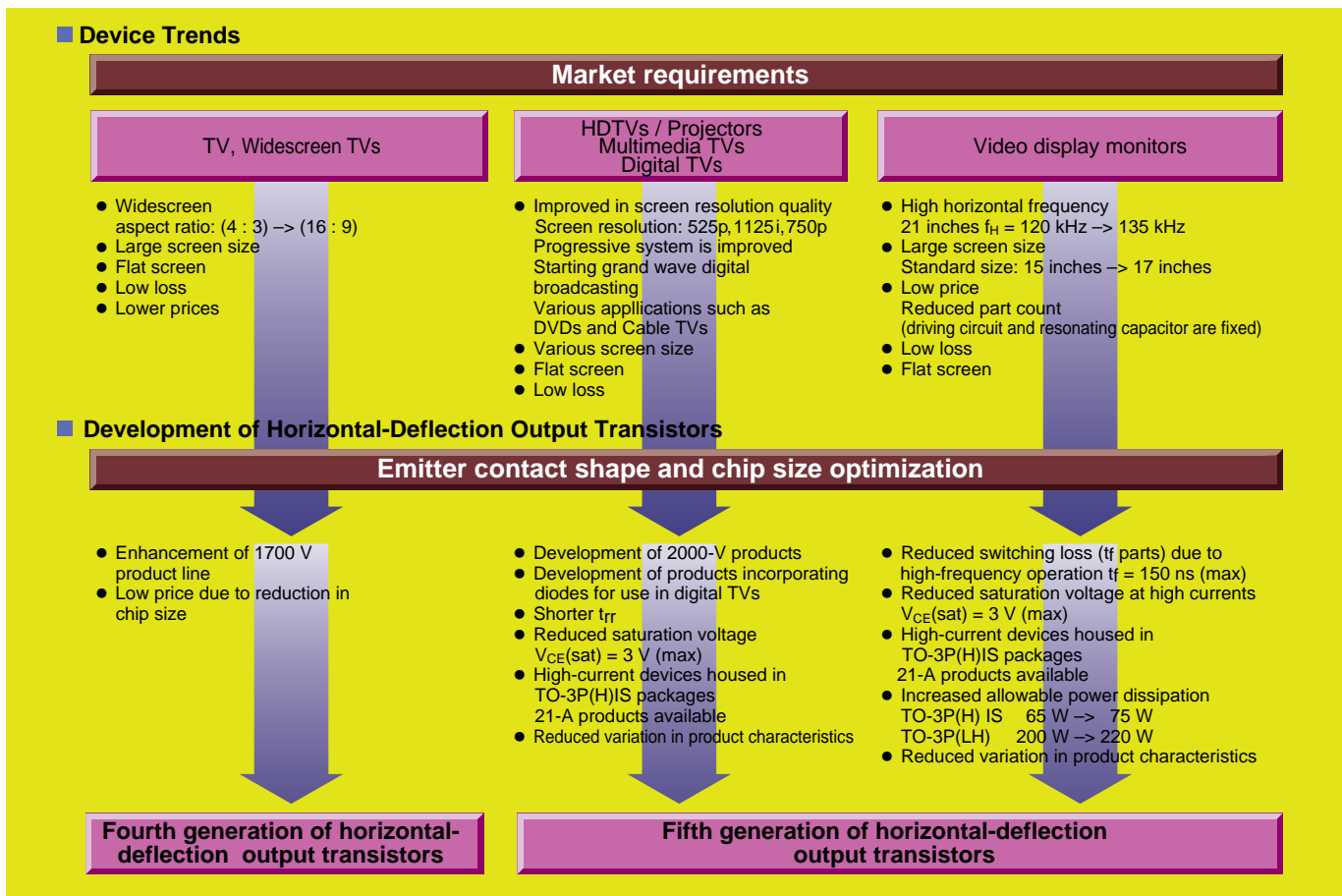

# 4 Features of Fourth and Fifth Generation

### 1 High breakdown capability

The product features a glass mesa structure, the use of which yields a wide forward- and reverse-biased safe operating area.

### 2 Low saturation voltage

$V_{CE(sat)} = 3 \text{ V (max)}$   
Note: Used for 2SC Series devices without damper diodes.

### 3 Wider range of optimum drive conditions

Fluctuation in optimum drive conditions due to variation in device quality has been minimized for ease of design.

### 4 Revised emitter contact shape and optimized chip size

Chip design has been optimized using Toshiba simulation technology. The emitter's contact area has been widened by changing the contact shape below the emitter electrode from comb type to the new mesh type. As a result, the saturation voltage ( $V_{CE(sat)}$ ) and fall time ( $t_f$ ) have both been reduced, thus reducing switching loss.

#### Toshiba's proprietary "glass mesa" structure

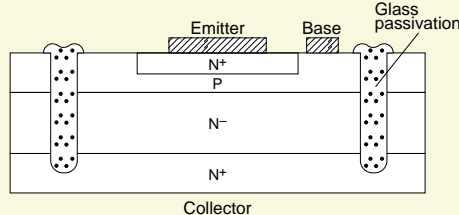

#### Contact shape

Conventional comb type

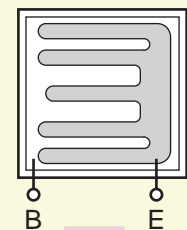

Fourth and fifth-generation mesh type

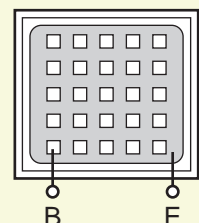

# 5 Comparison of Product Characteristic Curve, Features and Emitter-Contact Design

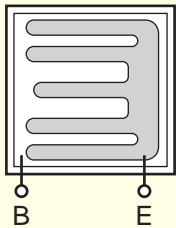
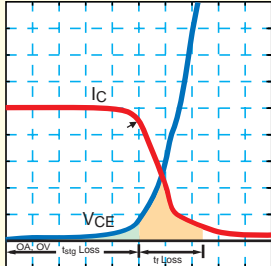
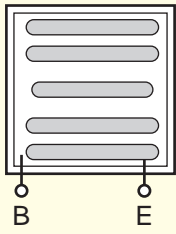
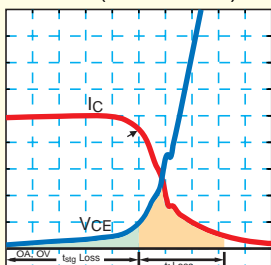
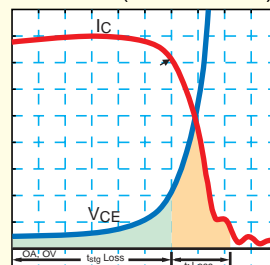
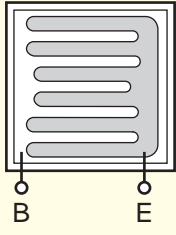
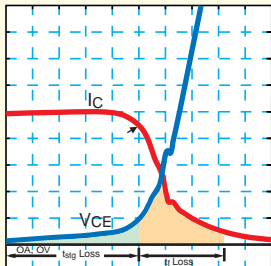
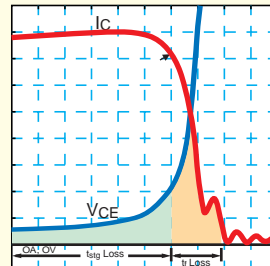
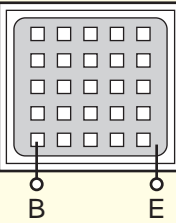
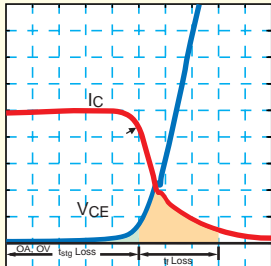
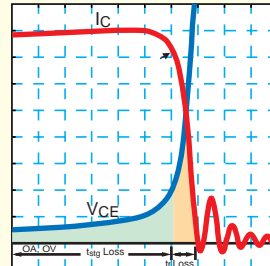
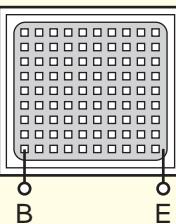
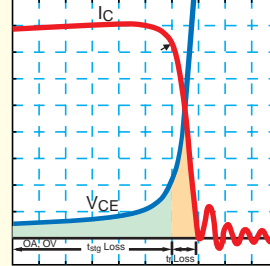
Generation	Design	Typical Products and Waveforms	
<ul style="list-style-type: none"> <li>Main application</li> <li>Features</li> </ul>	Emitter contact shape	TVs	Video displays
	@ $f_H$ , $I_{CP}$ , $I_{B1}(\text{end})$ , $V_{CP}$	@15.75kHz, 5A, 1A, 1200V	@100kHz, 8A, 1A, 1200V
	( $t$ , $I_C$ , $V_{CE}$ ) / div	(200ns, 1A, 10v) / div	(50ns, 1A, 10v) / div
<b>First Generation</b> <ul style="list-style-type: none"> <li>TVs <ul style="list-style-type: none"> <li>High-voltage → 1500 V</li> <li>Improved R-SOA</li> <li>Improved switching speeds <math>f_H(\text{max}) = 32</math> kHz</li> <li>Development of TO-3P(H)IS Package</li> </ul> </li> </ul>	<b>Comb type I</b> 	<b>2SD1556 (1500 V / 6A)</b> 	
<b>Second Generation</b> <ul style="list-style-type: none"> <li>TVs <ul style="list-style-type: none"> <li>High-current devices products</li> </ul> </li> <li>Video displays <ul style="list-style-type: none"> <li>Improved switching speeds <math>f_H(\text{max}) = 64</math> kHz</li> <li>Development of TO-3P(LH) Package</li> </ul> </li> </ul>	<b>STRIPLE type</b> 	<b>2SD2253 (1700 V / 6A)</b> 	<b>2SC4290A (1500 V / 20A)</b> 
<b>Third Generation</b> <ul style="list-style-type: none"> <li>TVs <ul style="list-style-type: none"> <li>Improvements over first-generation products</li> </ul> </li> <li>Video displays <ul style="list-style-type: none"> <li>Improvements over second-generation products</li> <li>Improved switching speeds <math>f_H(\text{max}) = 80</math> kHz</li> </ul> </li> </ul>	<b>Comb type II</b> 	<b>2SD2553 (1700 V / 8A)</b> 	<b>2SC5142 (1500 V / 20A)</b> 
<b>Fourth Generation</b> <ul style="list-style-type: none"> <li>TVs <ul style="list-style-type: none"> <li>Improvements over first- and third-generation products</li> </ul> </li> <li>Digital TVs <ul style="list-style-type: none"> <li>Development of new 2000-V products</li> </ul> </li> <li>Video displays <ul style="list-style-type: none"> <li>Improvements over third-generation products</li> <li>Improved switching speeds <math>f_H(\text{max}) = 130</math> kHz</li> </ul> </li> </ul>	<b>Mesh type I or Crystal-mesh type</b> 	<b>2SD2638 (1700 V / 7A)</b> 	<b>2SC5445 (1500 V / 20A)</b> 
<b>Fifth Generation</b> <ul style="list-style-type: none"> <li>Digital TVs <ul style="list-style-type: none"> <li>Enhanced 2000-V product line</li> <li>Improved speeds for products incorporating damper diodes</li> </ul> </li> <li>Video displays <ul style="list-style-type: none"> <li>Improvements over fourth-generation products</li> <li>Reduced loss</li> <li>Improvement in drivability</li> </ul> </li> </ul>	<b>Mesh type II</b> 		<b>2SC5695 (1500 V / 22A)</b> 

# 6 New Products

## 2SC Series

Part Number	Maximum Ratings			Package**	Di ***	Main Target Use	Remarks
	V <sub>CB0</sub> (V)	I <sub>C</sub> (A)	P <sub>C</sub> (W)				
<b>2SC5695</b>	1500	22	200	LH		21 inch, 130 kHz	Equivalent to 2SC5445
<b>2SC5716</b>	1700	8	55	H	✓	28 inch, 32 kHz to~	High-current version of 2SC5143
<b>2SC5717</b>	1500	21	75	H		19 inch, 120 kHz	2SC5717 and 2SC5695 use same chip.
<b>2SC5748</b>	2000	16	210	LH		36 inch, 32 kHz to~	2000 V series
<b>2SC5855</b>	1500	10	50	H		17 inch, 69 kHz	Equivalent to 2SC5387
<b>2SC5856</b>	1500	14	55	H		19 inch, 92 kHz	Equivalent to 2SC5411
<b>2SC5857</b>	1700	21	75	H		36 inch, 45 kHz	High-current version of 2SC5588
<b>2SC5858</b>	1700	22	200	LH		36 inch, 45 kHz	2SC5857 and 2SC5858 use same chip.
<b>2SC5859</b>	1700	23	210	LH		36 inch, 32 kHz to~	High-current version of 2SC5446
<b>* S3G18</b>	1700	(16)	75	H	✓	36 inch, 45 kHz to~	High-current version of 2SC5716
<b>* 2SC5997</b>	2000	(14)	75	H		36 inch, 45 kHz to~	2000 V series
<b>* S3G90</b>	1500	(18)	60	H		19 inch, 110 kHz	High-current version of 2SC5856
<b>* S3H58</b>	1500	(10)	50	H	✓	32 inch, 45 kHz	High-current version of 2SC5280
<b>* S3H60</b>	2000	(10)	60	H	✓	32 inch, 45 kHz	2000 V series and built-in damper diode

## 2SD Series

<b>2SD2638</b>	1700	7	50	H	✓	28 inch - 15.75 kHz	Low-current version of 2SD2553
----------------	------	---	----	---	---	---------------------	--------------------------------

Note \*: Under development and tentative specification \*\*\*Di: Built-in damper diode  
Package \*\*: H...TO-3P(H)IS. LH...TO-3P(LH)

# 7 Cross Reference

< How to use this table >

Step 1. Check \*\*I<sub>C(sat)</sub> of other devices.

Step 2. Check V<sub>CB0</sub>, package and built-in damper diode or not built-in damper diode.

Step 3. Look for applicable area as step 1 & 2.

Step 4. Recommended devices near to that area.

Package	V <sub>CB0</sub> = 1500 V			V <sub>CB0</sub> = 1700 V			V <sub>CB0</sub> = 2000 V		
	TO-3P(H)IS		TO-3P(LH)	TO-3P(H)IS		TO-3P(LH)	TO-3P(H)IS		TO-3P(LH)
P <sub>C</sub> max	40 to 75 W		180 to 220 W	40 to 75 W		180 to 220 W	40 to 75 W		180 to 220 W
** I <sub>C(sat)</sub>	Built-in damper	Not built-in damper	Not built-in damper	Built-in damper	Not built-in damper	Not built-in damper	Built-in damper	Not built-in damper	Not built-in damper
3 A	<b>2SD2599</b>			<b>2SD2550</b>					
3.5 A	<b>2SD2586</b>								
4 A	<b>2SD2499</b>	<b>2SD2498</b>		<b>2SD2551</b>					
4.5 A	<b>S2055N</b>	<b>S2000N</b>							
5 A	<b>2SD2539</b>								
	<b>2SC5339</b>								
5.5 A				<b>2SD2638</b>					
6 A	<b>2SC5280</b>	<b>2SC5386</b>		<b>2SC5716</b>					
	<b>2SD2559</b>	<b>2SD2500</b>		<b>2SD2553</b>					
7 A		<b>2SC5404</b>							
8 A	<b>* S3H58</b>	<b>2SC5387</b>					<b>* S3H60</b>		
		<b>2SC5855</b>							
11 A		<b>2SC5411</b>	<b>2SC5421</b>				<b>2SC5422</b>		<b>* 2SC5997</b>
		<b>2SC5856</b>							
12 A				<b>* S3G18</b>	<b>2SC5588</b>	<b>2SC5590</b>			<b>2SC5748</b>
14 A		<b>2SC5587</b>	<b>2SC5589</b>			<b>2SC5446</b>			
		<b>* S3G90</b>							
15 A			<b>2SC5445</b>						
17 A		<b>2SC5717</b>	<b>2SC5695</b>		<b>2SC5857</b>	<b>2SC5858</b>			<b>2SC5612</b>
18 A						<b>2SC5859</b>			
22 A						<b>2SC5570</b>			

Note. **2SC** : 3rd Generation (old design)

**2SC** : 4th Generation (new design)

**2SC** : 5th Generation (new design)

\* : Under development and tentative specification

\*\* : I<sub>C(sat)</sub> is value of IC condition for V<sub>CE(sat)</sub>.

# 8 Characteristics List

## ① 2SC Series

Part Number	Maximum Ratings			** pack- age	*** Di	h <sub>FE</sub>			V <sub>CE(sat)</sub> Max(V)			Switching Time (Typ.)				Gene- ration
	V <sub>CBO</sub> (V)	I <sub>C</sub> (A)	P <sub>C</sub> (W)			Min (-)	Max (-)	@5 V / I <sub>C</sub> (A)	@I <sub>C(sat)</sub> (A)	@ I <sub>B</sub> (A)	t <sub>stg</sub> (us)	t <sub>r</sub> (us)	@ f <sub>H</sub> (kHz)	@ I <sub>CP</sub> (A)		
2SC5280	1500	8	50	H	✓	4	8.5	6	5	6	1.5	4	0.2	31.5	6	4th
2SC5339	1500	7	50	H	✓	4	8	5	5	5	1.25	4	0.2	31.5	5	4th
2SC5386	1500	8	50	H		4.3	7.5	6	3	6	1.5	2.5	0.15	64	5	4th
2SC5387	1500	10	50	H		4.3	7.8	8	3	8	2	2.5	0.15	64	6	4th
2SC5404	1500	9	50	H		4	8	7	3	7	1.75	2.5	0.15	64	5.5	4th
2SC5411	1500	14	60	H		4	8	11	3	11	2.75	2.5	0.15	64	8.5	4th
2SC5421	1500	15	180	LH		4	8	11	3	11	2.75	2.5	0.15	64	8.5	4th
2SC5422	1700	15	200	LH		4.5	8.5	11	3	11	2.75	2.5	0.15	64	8	4th
2SC5445	1500	20	200	LH		4.5	8.5	15	3	15	3.75	2	0.1	100	8	4th
2SC5446	1700	18	200	LH		4	8	14	3	14	3.5	2.1	0.1	100	7	4th
2SC5570	1700	28	220	LH		4.5	7.5	22	3	22	5.5	1.4	0.1	130	8	4th
2SC5587	1500	17	75	H		5	8	14	3	14	3.5	1.8	0.1	100	7.5	4th
2SC5588	1700	15	75	H		4.8	8	12	3	12	3	1.8	0.1	100	6.5	4th
2SC5589	1500	18	200	LH		5	8	14	3	14	3.5	1.8	0.1	100	7.5	4th
2SC5590	1700	16	200	LH		4.8	8	12	3	12	3	1.8	0.1	100	6.5	4th
2SC5612	2000	22	220	LH		4.8	9	17	3	17	4.25	4	0.15	32	8	4th
2SC5695	1500	22	200	LH		4.5	8.5	17	3	17	3.75	1.6	0.1	100	8	5th
2SC5716	1700	8	55	H	✓	3.8	9	6	5	6	1.5	3.5	0.2	32	5.5	4th
2SC5717	1500	21	75	H		4.5	8.5	17	3	17	3.75	1.6	0.1	100	8	5th
2SC5748	2000	16	210	LH		4.8	7.5	12	3	12	3	4	0.15	32	8	5th
2SC5855	1500	10	50	H		4.3	6.7	8	3	8	2	2.3	0.1	80	5.5	5th
2SC5856	1500	14	55	H		4.5	7.8	11	3	11	2.75	1.8	0.1	100	6.5	5th
2SC5857	1700	21	75	H		5	7.5	17	1.5	17	4.25	3.5	0.1	45	8	5th
2SC5858	1700	22	200	LH		5	7.5	17	1.5	17	4.25	3.5	0.1	45	8	5th
2SC5859	1700	23	210	LH		4.5	8	18	3	18	4.5	1.8	0.1	100	7.5	5th
* S3G18	1700	(16)	75	H	✓	(4)	(8)	(12)	(3)	(12)	(3)	(3.5)	(0.1)	(45)	(8)	5th
*2SC5997	2000	(14)	75	H		(5)	(7.2)	(11)	(1.5)	(11)	(2.75)	(5)	(0.12)	(32)	(6)	5th
* S3G90	1500	(18)	60	H		(5)	(8)	(14)	(3)	(14)	(3.5)	(1.8)	(0.1)	(100)	(7.5)	5th
* S3H58	1500	(10)	50	H	✓	(4.5)	(7.5)	(8)	(3)	(8)	(2)	(3.5)	(0.2)	(45)	(6)	5th
* S3H60	2000	(10)	60	H	✓	(4.5)	(7.5)	(8)	(3)	(8)	(2)	(3.5)	(0.2)	(45)	(6)	5th

## ② 2SD Series

Part Number	Maximum Ratings			** pack- age	Built-in damper diode : ✓	h <sub>FE</sub>			V <sub>CE(sat)</sub> Max(V)			Switching Time (Typ.)				Gene- ration
	V <sub>CBO</sub> (V)	I <sub>C</sub> (A)	P <sub>C</sub> (W)			Min (-)	Max (-)	@5 V / I <sub>C</sub> (A)	@I <sub>C(sat)</sub> (A)	@ I <sub>B</sub> (A)	t <sub>stg</sub> (us)	t <sub>r</sub> (us)	@ f <sub>H</sub> (kHz)	@ I <sub>CP</sub> (A)		
2SD2498	1500	6	50	H		5	9	4	5	4	0.8	7	0.4	15.75	4	3rd
2SD2499	1500	6	50	H	✓	5	9	4	5	4	0.8	7.5	0.3	15.75	4	3rd
2SD2500	1500	10	50	H		4	8	6	3	6	1.5	8	0.35	15.75	6	3rd
2SD2539	1500	7	50	H	✓	5	9	5	5	5	1	6	0.3	15.75	5	3rd
2SD2550	1700	4	50	H	✓	8	22	1	8	3	0.8	7.5	0.3	15.75	3	3rd
2SD2551	1700	5	50	H	✓	5	10	4	5	4	0.8	7.5	0.5	15.75	4	3rd
2SD2553	1700	8	50	H	✓	5	9	6	5	6	1.2	9	0.3	15.75	6	3rd
2SD2559	1500	8	50	H	✓	5	9	6	5	6	1.2	6	0.4	15.75	6	4th
2SD2586	1500	5	50	H	✓	4.4	8.5	3.5	5	3.5	0.8	7.5	0.3	15.75	3.5	4th
2SD2599	1500	3.5	40	H	✓	8	25	0.5	8	3	0.8	7.5	0.5	15.75	3	4th
2SD2638	1700	7	50	H	✓	4.5	7.5	5.5	5	5.5	1.2	7	0.4	15.75	5.5	4th

## ③ S2000 / 2055 Series

Part Number	Maximum Ratings			** pack- age	Built-in damper diode : ✓	h <sub>FE</sub>			V <sub>CE(sat)</sub> Max(V)			Switching Time (Typ.)				Gene- ration
	V <sub>CBO</sub> (V)	I <sub>C</sub> (A)	P <sub>C</sub> (W)			Min (-)	Max (-)	@5 V / I <sub>C</sub> (A)	@I <sub>C(sat)</sub> (A)	@ I <sub>B</sub> (A)	t <sub>stg</sub> (us)	t <sub>r</sub> (us)	@ f <sub>H</sub> (kHz)	@ I <sub>CP</sub> (A)		
S2000N	1500	8	50	H		4.5	9	4.5	5	4.5	1	8	0.4	15.75	4.5	3rd
S2055N	1500	8	50	H	✓	4.5	9	4.5	5	4.5	1	7.5	0.3	15.75	4.5	3rd

\*: Under development & tentative spec.

\*\* : H ; TO-3P(H)IS LH ; TO-3P(LH)

# 9 Selection Tables for Video Displays *(Reference only)*

## ●Video Display Monitor Horizontal-Deflection-Output Transistors ( $V_{CBO} = 1500\text{ V}$ series)

Intended Uses for Horizontal-Deflection-Output Transistors (Note 2)													Package / Recommended Alternative Product (for reference)				Maximum Ratings		Design Generation	
Screen size <lcp> & maximum horizontal frequency <fH(max)>													TO-3P(H)IS		TO-3P(LH)		Ic	Pc		
15 inch ICP = 4.5 A: ●▲ ICP = 5.0 A: ○△			17 inch ICP = 5.5 A: ● ICP = 6.0 A: ○			19 inch ICP = 6.5 A: ● ICP = 7.0 A: ○			21 inch ICP = 7.5 A: ● ICP = 8.0 A: ○								(A)	(W)		
fH@(max)													Damper diode		Damper diode				(Note 3)	(Note 1)
54 kHz	69 kHz	69 kHz	82 kHz	96 kHz	82 kHz	96 kHz	107 kHz	120 kHz	96 kHz	107 kHz	120 kHz	135 kHz	Built-in	Not Built-in	Built-in	Not Built-in				
▲													2SC5339				7	50	4th	
	○													2SC5386			8	50	4th	
▲													2SC5280				8	50	4th	
	○	●												2SC5404			9	50	4th	
	○	○	●											2SC5855			10	50	5th	
	○	○	●											2SC5387			10	50	4th	
				○	○	●								2SC5411			14	60	4th	
				○	○	○	●	●	●					2SC5856			14	55	5th	
								○	○	●					2SC5421		15	180	4th	
									○	○	●			2SC5587			17	75	4th	
								○	○	●	●			* S3G90			18	60	5th	
												○				2SC5589	18	200	4th	
												○				2SC5445	20	200	4th	
												○	●			2SC5717	21	75	5th	
												○	●			2SC5695	22	200	5th	

## ●Video Display Monitor Horizontal-Deflection-Output Transistors ( $V_{CBO} = 1700\text{ V}$ series)

Intended Uses for Horizontal-Deflection-Output Transistors (Note 2)													Package / Recommended Alternative Product (for reference)				Maximum Ratings		Design Generation	
Screen size <lcp> & maximum horizontal frequency <fH(max)>													TO-3P(H)IS		TO-3P(LH)		Ic	Pc		
15 inch ICP = 4.5 A: ●▲ ICP = 5.0 A: ○△			17 inch ICP = 5.5 A: ● ICP = 6.0 A: ○			19 inch ICP = 6.5 A: ● ICP = 7.0 A: ○			21 inch ICP = 7.5 A: ● ICP = 8.0 A: ○								(A)	(W)		
fH@(max)													Damper diode		Damper diode				(Note 3)	(Note 1)
54 kHz	69 kHz	69 kHz	82 kHz	96 kHz	82 kHz	96 kHz	107 kHz	120 kHz	96 kHz	107 kHz	120 kHz	135 kHz	Built-in	Not Built-in	Built-in	Not Built-in				
△													2SC5716				8	50	4th	
				○	○	●								2SC5588			15	75	4th	
				○	○	○	●								2SC5590		16	200	4th	
							○	●							2SC5446		18	200	4th	
							○	●						2SC5857			21	75	5th	
								○	●						2SC5858		22	200	5th	
									○	●					2SC5859		23	210	5th	
											○	○			2SC5570		28	220	4th	

Note 1: 4th and 5th generation devices are new products.

\* : Under development and specifications are tentative.

Note 2: The screen size and frequency quoted for intended use and reference only. △ ▲: Need to additional damper diode

Note 3: Tc = 25°C

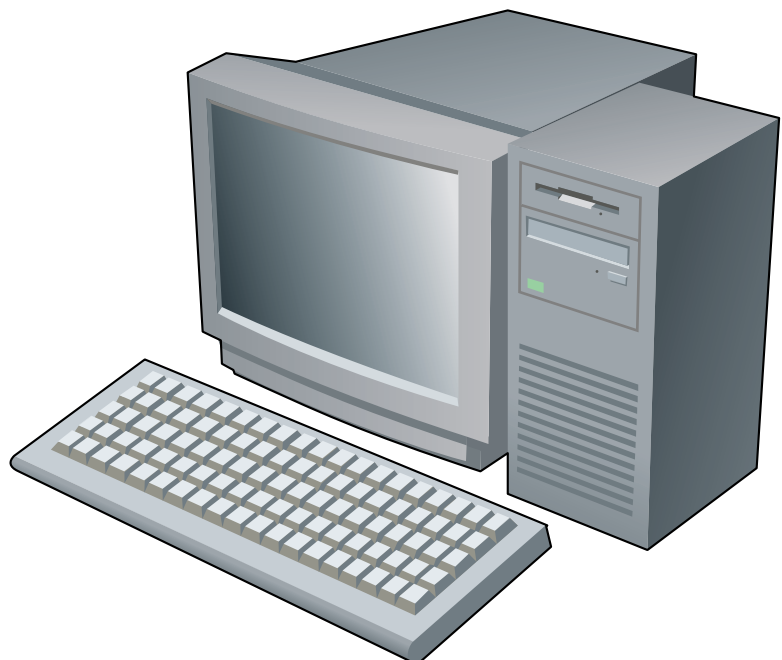

# 9 Selection Tables for Color TVs *(Reference only)*

## ●Color TV Horizontal-Deflection-Output Transistors ( $V_{CBO} = 1500\text{ V}$ Series)

Intended Uses for Horizontal-Deflection-Output Transistors (Note 2)																Package / Recommended Alternative Product (for reference)				Maximum Ratings		Design Generation (Note 1)		
Flat and wide-screen & Projector TVs								HDTV & Digital TVs								TO-3P(H)IS		TO-3P(LH)		Ic (A)	Pc (W)			
525i (480i) fH = 15.75 kHz				525p (480p) fH = 31.5 kHz				1125i (1080i) fH = 33.75 kHz				750p (720p) fH = 45k Hz to				Damper diode		Damper diode						
D1 pin				D2 pin				D3 pin				D4 pin				Built-in		Not Built-in						
Screen size (Main inches)				Screen size (Main inches)				Screen size (Main inches)				Screen size (Main inches)				Built-in		Not Built-in		(Note 3)	(Note 1)			
16	20	24	28	32	36	36 to	20	24	28	32	36	28	32	36	28	32	36							
●																		2SD2599				3.5	40	4th
●	●																	2SD2586				5	50	4th
	●	●																2SD2498				6	50	3rd
	●	●																2SD2499				6	50	3rd
		●	●															2SD2539				7	50	3rd
		●	●				●											2SC5339				7	50	4th
		●	●															2SD2559				8	50	4th
	●	●																S2000N				8	50	3rd
	●	●																S2055N				8	50	3rd
			●	●					●									2SC5386				8	50	4th
			●	●					●									2SC5280				8	50	4th
			●	●					●	●								2SC5404				9	50	4th
			●	●		●			●	●		●						* S3H58				10	50	5th
			●	●					●									2SD2500				10	50	3rd
			●	●					●									2SC5855				10	50	5th
			●	●					●									2SC5856				14	55	5th
			●	●					●									* S3G90				17	60	5th
			●	●					●									2SC5587				18	75	4th
			●	●					●													18	200	4th
			●	●					●													20	200	4th
			●	●					●									2SC5717				21	75	5th
			●	●					●													22	200	5th

## ●Color TV Horizontal-Deflection-Output Transistors ( $V_{CBO} = 1700\text{ V}$ Series)

●	●																	2SD2550				4	50	3th
	●	●																2SD2551				5	50	3th
		●	●															2SD2638				7	50	4th
		●	●															2SD2553				8	50	3th
		●	●				●											2SC5716				8	50	4th
			●	●					●									2SC5588				15	75	4th
			●	●					●									*S3G18				16	75	5th
			●	●					●													16	200	4th
			●	●					●													21	75	5th
			●	●					●													22	200	5th
			●	●					●													23	210	5th
			●	●					●													28	220	4th

## ●Color TV Horizontal-Deflection-Output Transistors ( $V_{CBO}=2000\text{V}$ Series)

						●			●									*S3H60				10	50	5th	
						●			●										*2SC5997				14	75	5th
						●			●														18	210	5th
						●			●														22	220	4th

Note 1: 4th and 5th generation devices are new products.

\*: Under development and specifications are tentative.

Note 2: The screen size and frequency quoted for intended use and reference only.

Note 3:  $T_c=25^\circ\text{C}$

Note 4: Scan type is showed by the number of vertical pixels and scan mode.

e.g.525i means 525 vertical pixels and interlace scan. 720p means 720 vertical pixels and progressive scan.

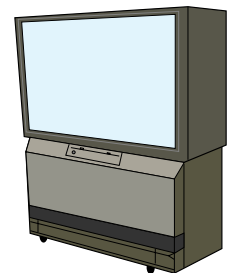



# 10 Basic Circuit Structure and Operating Waveform of Horizontal-Deflection Output

## Measurement conditions

$f_H = 69 \text{ kHz}$  (duty 50%)  
 $I_{CP} = 5 \text{ A}$   
 $V_{CP} = 1200 \text{ V}$

## Basic circuit structure

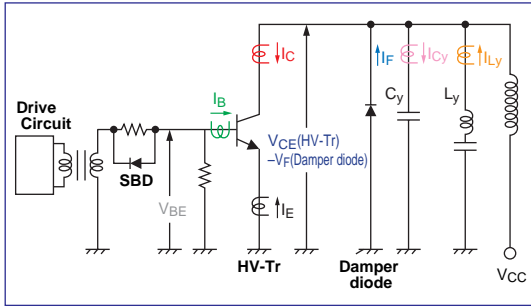

## Measurement range

### X-axis

$t$  (time)  $2 \mu\text{s} / \text{div}$

### Y-axis

$V_{BE}$  (Base-emitter voltage)  $5 \text{ V} / \text{div}$

$I_B$  (Base current)  $2 \text{ A} / \text{div}$

$I_C$  (Collector current)  $2 \text{ A} / \text{div}$

$-I_E$  (Reverse emitter current)  $2 \text{ A} / \text{div}$

$I_F$  (Forward current)  $2 \text{ A} / \text{div}$

$V_{CE}$  (Collector-emitter voltage)  $200 \text{ V} / \text{div}$

$I_{LY}$  (Deflection coil current)  $2 \text{ A} / \text{div}$

$I_{CY}$  (Resonance capacitor current)  $2 \text{ A} / \text{div}$

## Enlarged wave forms of $I_B$ and $I_C$

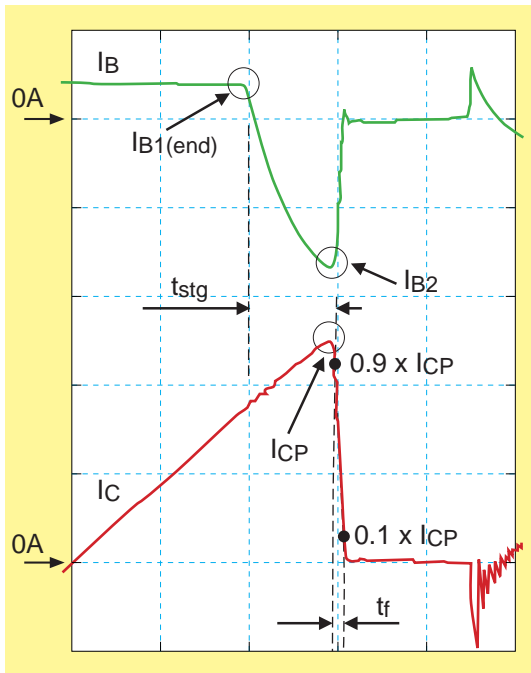

## Main operations



## Operating waveform example

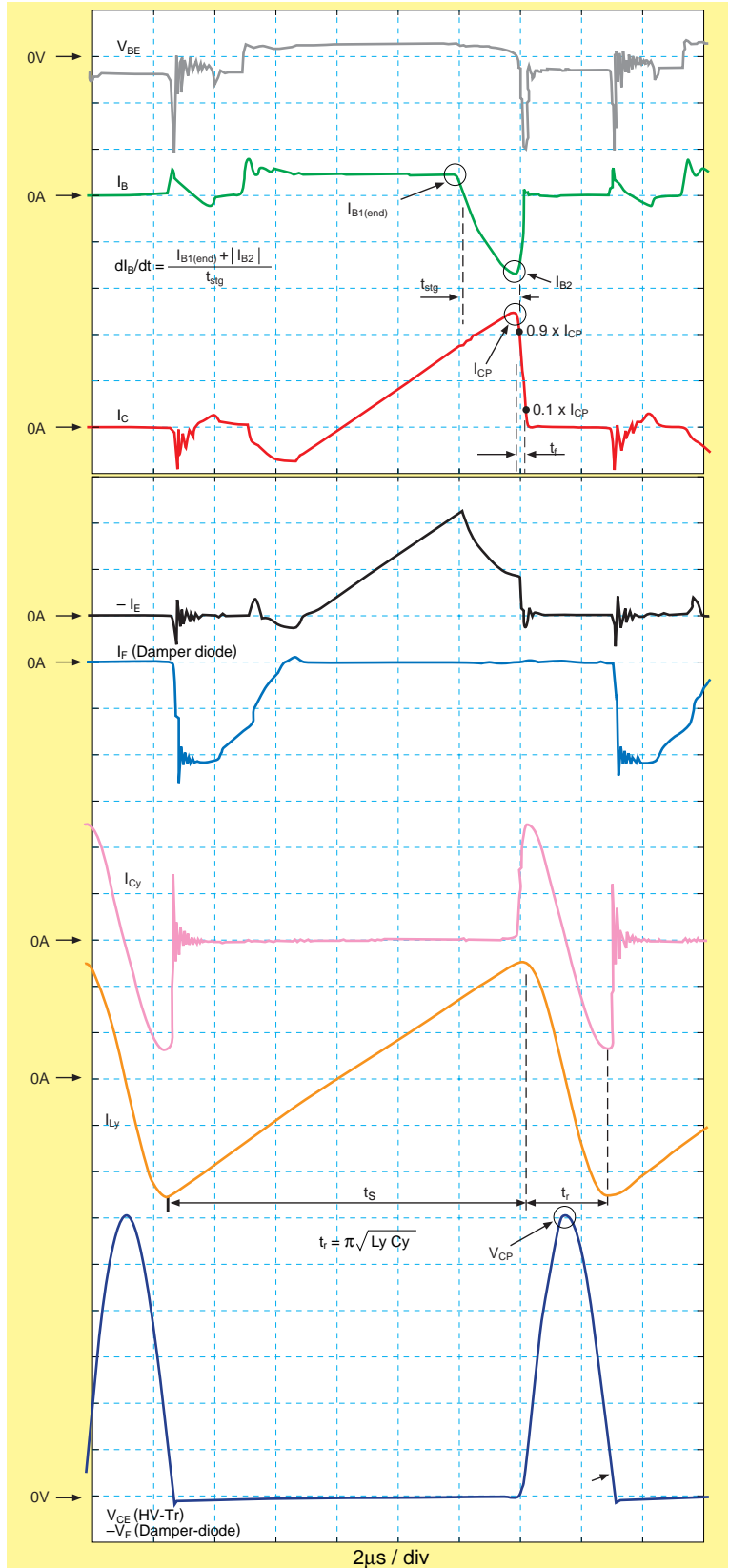

# 11 Switching Data for monitor applications (5th design)

(Reference only)

## 2SC5695

### 1 Test condition

@  $T_C \cong 25^\circ\text{C}$

$f_H = 105\text{ kHz}$  (duty 50%, continuous operation)

$I_{CP} = 6.5\text{ A} \rightarrow V_{CP} \cong 953\text{ V}$  ( $V_{CC2} \cong 107\text{ V}$ )

$I_{CP} = 8.5\text{ A} \rightarrow V_{CP} \cong 1220\text{ V}$  ( $V_{CC2} \cong 140\text{ V}$ )

$-dI_B / dt \cong 4.0\text{ A}/\mu\text{s}$  ( $V_{CC1} = 24\text{ V}$ )

$L_y = 63\text{ }\mu\text{H}$ ,  $C_y = 4000\text{ pF}$

### 2 Test sample

Mark		Test Sample	hFE (1) @5 V / 2 A		hFE (2) @5 V / 10 A		hFE (3) @5 V / 17 A		VCE (sat) @17 A / 4.25 A
$I_{CP} = 6.5\text{ A}$	$I_{CP} = 8.5\text{ A}$		Standard specs.	20 (min) 50 (max)	8 (min) 17 (max)	4.8 (min) 8.3 (max)	3 V (max)		
○---○	○---○	tail side	50.5	15.6	8.2	8.2	0.4 V		
△---△	△---△	Typ	33.8	12.1	6.6	6.6	0.6 V		
×---×	×---×	storage side	24.1	8.2	4.6	4.6	2.9 V		

### 3 tstg, tf, $-dI_B / dt$ , Switching Loss — $I_{B1}$ (end)

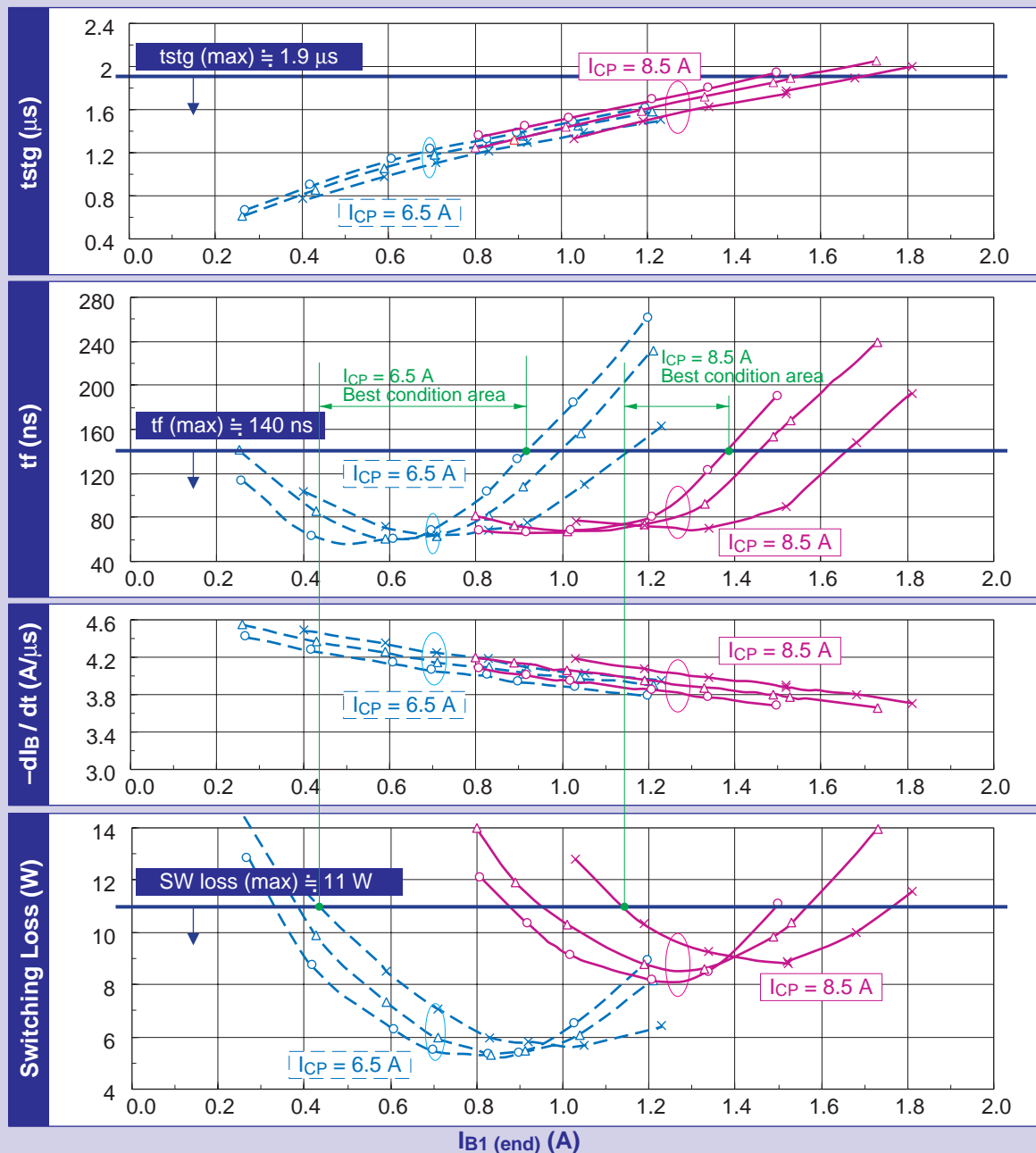

#### 4 Recommended values (rough calculation)

**tstg (max)**

$$tstg (max) = (1/f_H) \times 0.2$$

$$tstg (max) \approx 1.9 \mu s$$

**tf (max)**

$$tf (max) = (1/f_H) \times 0.01 + 50 ns$$

$$tf (max) \approx 140 ns$$

**Switching loss capacitance (max)**

@ Ta (max) = 40°C, Tj (max) = 110°C recommended  
 $\Delta T_j (max) = 110^\circ C - 40^\circ C$   
 $\rightarrow \Delta T_j (max) = 70^\circ C$  recommended

thermal resistance

junction to case: Rth (j-c) = 0.625°C/W (2SC5695)  
 case to fin (heat-sink): Rth (c-f) = 1°C/W (supposition)  
 +) fin (heat-sink) to air: Rth (f-a) = 3.5°C/W (supposition)

TOTAL (junction on ari): Rth (f-a) = 5.125°C/W

SW Loss Capacitance (max) =  $\Delta T_j (max) / Rth (j-a) \times 80\%$  derating  
 $= 70 / 5.125 \times 0.8$   
 $= 10.9$

$$SW \text{ loss capacitance (max)} \approx 11 \mu s$$

## 12 Application Circuit Example

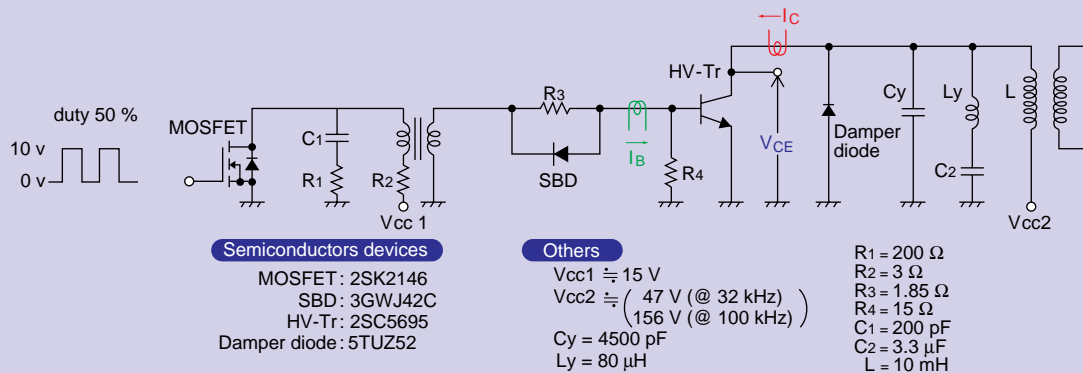

#### Operating waveform example (21-inch ultra-high-resolution monitor) f<sub>H</sub> = 32 kHz to 100 kHz monitor

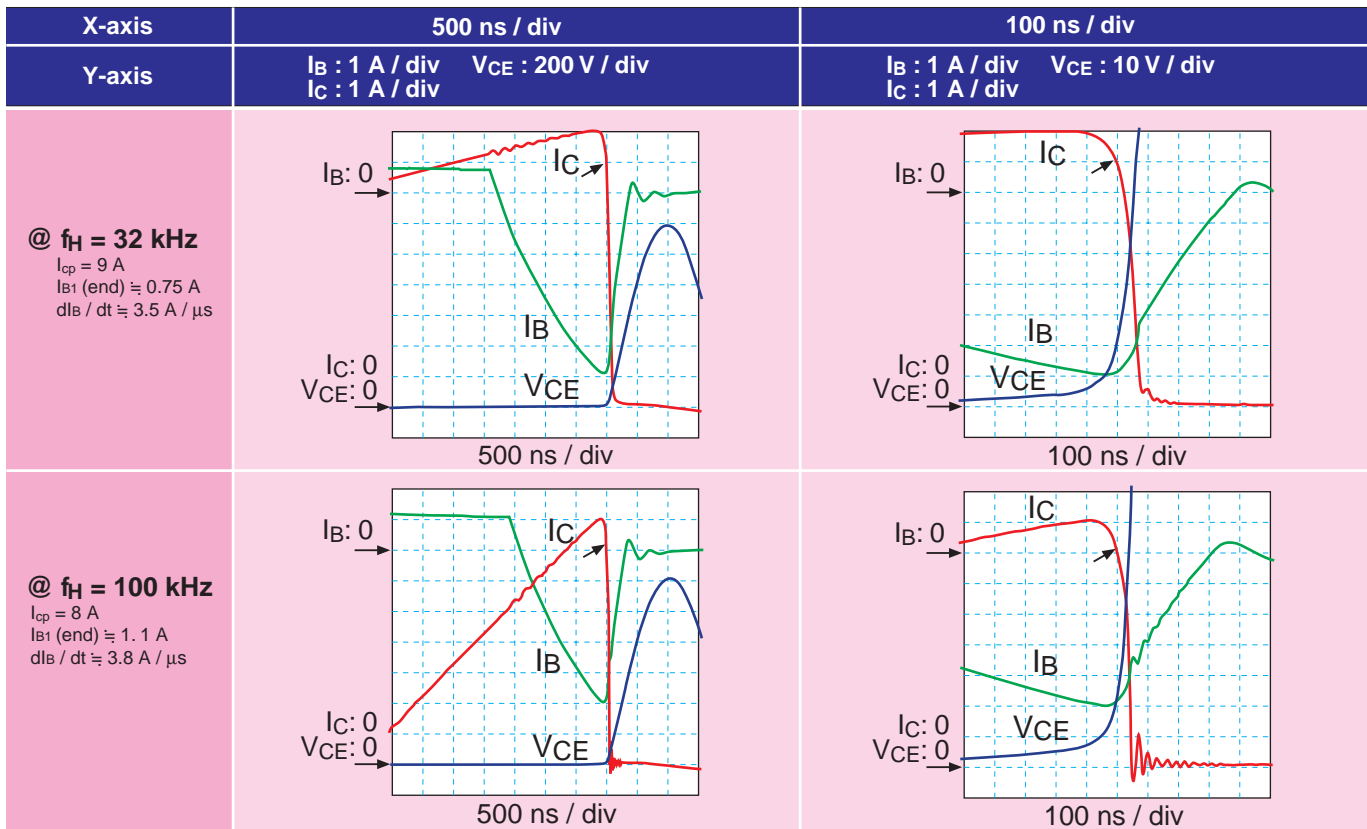

# 13 Switching Data for HDTV and PJTV Applications (4th design)

2SC5446 [1700 V / 18 A / 3P(LH)]

## Test condition

@  $T_c \cong 100^\circ\text{C}$

$f_H = 35 \text{ kHz}$  (duty 50%, 3 cycles operation)

$I_{CP} = 9 \text{ A} \rightarrow V_{CP} \cong 1350 \text{ V}$  ( $V_{CC2} \cong 157 \text{ V}$ )

$I_{B1}(\text{end}) = 1.2 / 1.4 / 1.6 \text{ A}$  ( $V_{BB} = 24.4 / 28.4 / 32.4 \text{ V}$ )

$L_y = 208 \mu\text{H}$ ,

$C_y = 12000 \text{ pF}$

## hFE minimum side Sample

### Sample Data

Test Conditions	hFE (1) @5 V / 2 A	hFE (2) @5 V / 9 A	hFE (3) @5 V / 14 A	VCE (sat) @14 A / 3.5 A
2SC5446 specifications	10 (min) 40 (max)	6 (min) 13 (max)	4 (min) 8 (max)	- 3 V (max)
Sample data	17.5	6.7	4.4	3.3 V

### tstg, tf, Switching Loss tstg Loss – $-dI_B/dt$

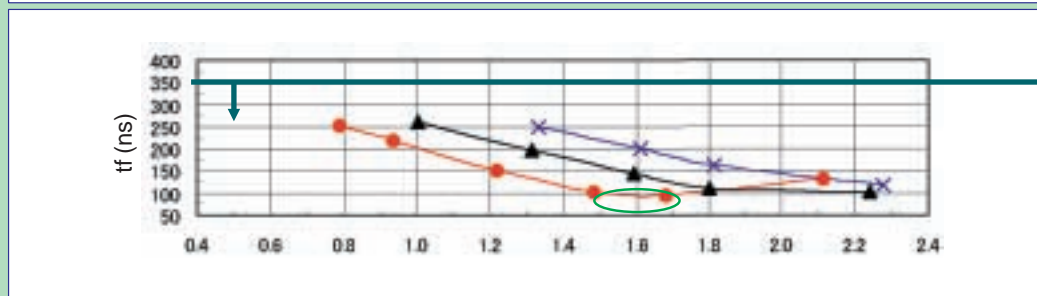
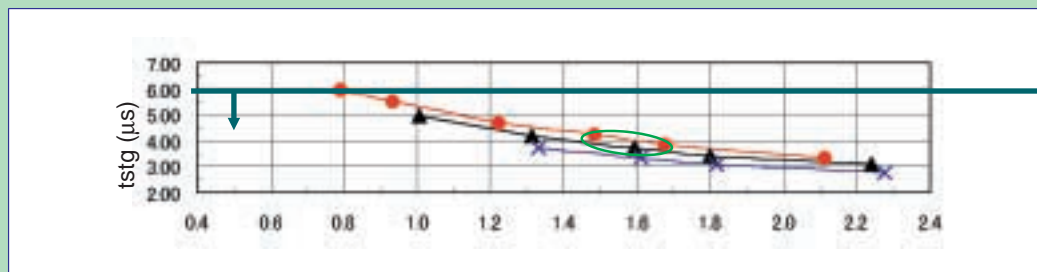

Drive ability	$I_{B1}(\text{end}) = 1.6 \text{ A}$
	$I_{B1}(\text{end}) = 1.4 \text{ A}$
	$I_{B1}(\text{end}) = 1.2 \text{ A}$

Best Drive

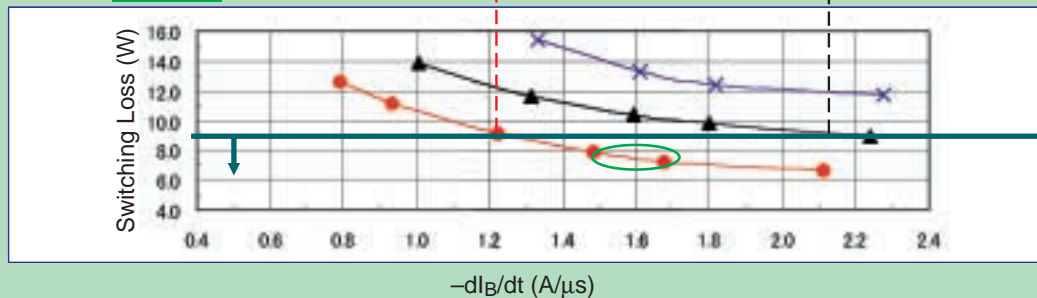

Best Drive conditions  
@  $I_{B1}(\text{end})$   
 $-dI_B/dt =$

Switching Loss  $\cong 7.5\text{W}$   
by hFE minimum side sample

Mark

I <sub>B1</sub> (end)		
1.2 A	1.4 A	1.6 A

hFE maximum side Sample

Sample Data

Test Conditions	hFE (1) @5 V / 2 A	hFE (2) @5 V / 9 A	hFE (3) @5 V / 14 A	VCE (sat) @14 A / 3.5 A
2SC5446 specifications	10 (min)	6 (min)	4 (min)	-
	40 (max)	13 (max)	8 (max)	3 V (max)
Sample data	28.6	11.7	7.5	0.4 V

tstg, tf, Switching Loss, tstg Loss – -dI<sub>B</sub>/dt

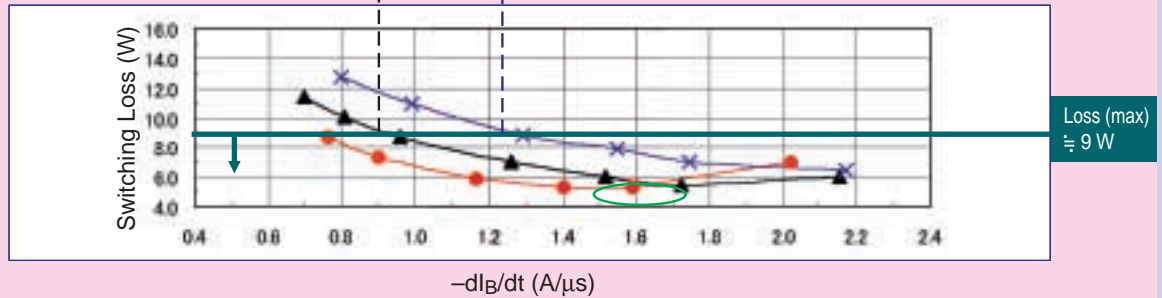
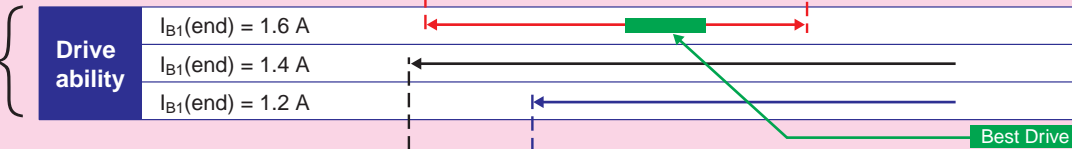
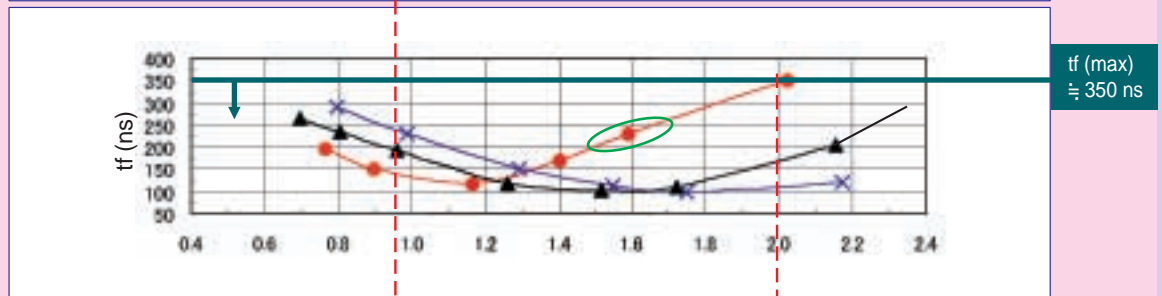
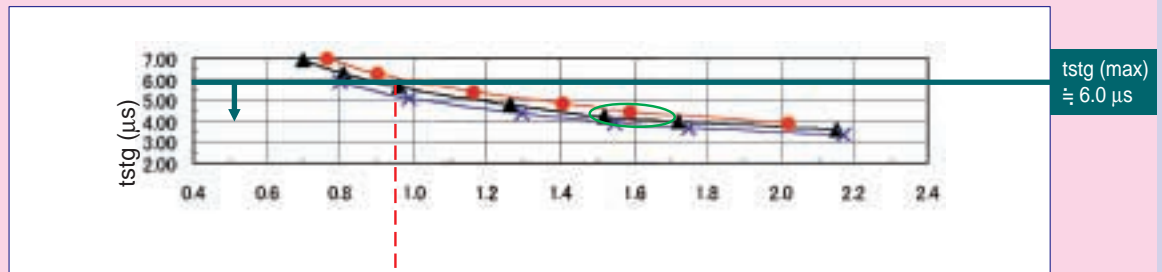

are =1.6A, 1.6A/μs

Switching Loss ≈ 5W by hFE maximum side sample

# 13 Switching Data for HDTV and PJTV Applications (5th design)

2SC5857 [1700 V / 21 A / 3P(H)IS] 2SC5858 [1700 V / 22 A / 3P(LH)]

## Test condition

@  $T_c \cong 100^\circ\text{C}$

$f_H = 35 \text{ kHz}$  (duty 50%, 3 cycles operation)

$I_{CP} = 9 \text{ A} \rightarrow V_{CP} \cong 1350 \text{ V}$  ( $V_{CC2} \cong 157 \text{ V}$ )

$I_{B1}(\text{end}) = 1.2 / 1.4 / 1.6 \text{ A}$  ( $V_{BB} = 24.4 / 28.4 / 32.4 \text{ V}$ )

$L_y = 208 \mu\text{H}$ ,

$C_y = 12000 \text{ pF}$

## hFE minimum side Sample

### Sample Data

Test Conditions	hFE (1) @5 V / 2 A	hFE (2) @5 V / 8 A	hFE (3) @5 V / 17 A	VCE (sat) @17 A / 4.25 A
2SC5857/5858 specifications	30 (min) 60 (max)	11 (min) 19 (max)	5 (min) 7.5 (max)	– 1.5 V (max)
Sample data	38.2	12.0	5.2	1.3 V

### tstg, tf, Switching Loss, tstg Loss – -dIB/dt

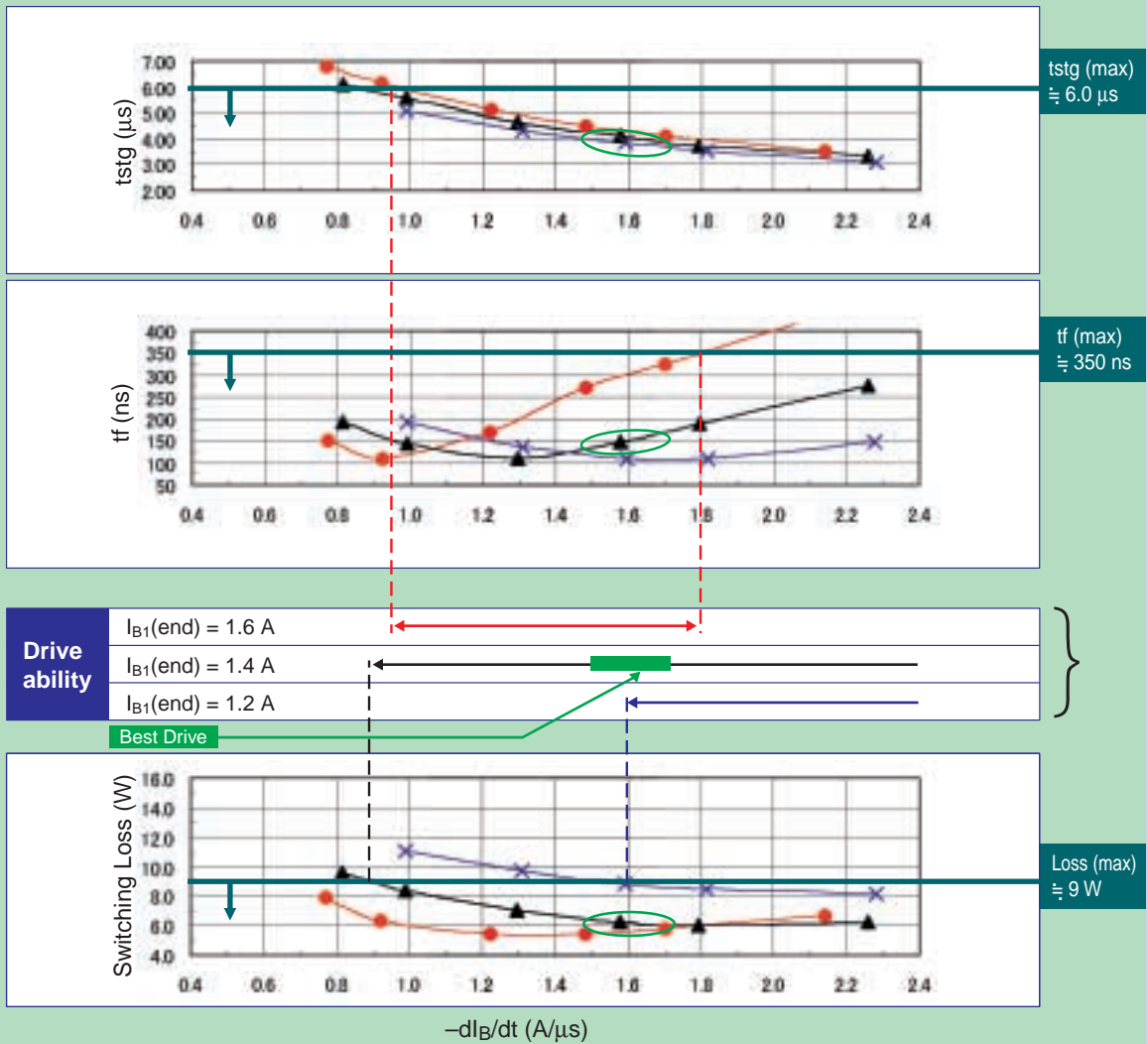

Switching Loss  $\cong 6.5\text{W}$   
by hFE minimum side sample

(Reference only)

Mark

I <sub>B1</sub> (end)		
1.2 A	1.4 A	1.6 A

2SC5857 and 2SC5858 (5th design) have better switching loss and I<sub>B1</sub>(end) characteristics than 2SC5446 does.

hFE maximum side Sample

Sample Data

Test Conditions	hFE (1) @5 V / 2 A	hFE (2) @5 V / 8 A	hFE (3) @5 V / 11 A	VCE (sat) @17 A / 4.25 A
2SC5857/5858 specifications	30 (min) 60 (max)	11 (min) 19 (max)	5 (min) 7.5 (max)	- 1.5 V (max)
Sample data	53.6	17.1	7.0	0.5 V

tstg, tf, Switching Loss, tstg Loss – -dI<sub>B</sub>/dt

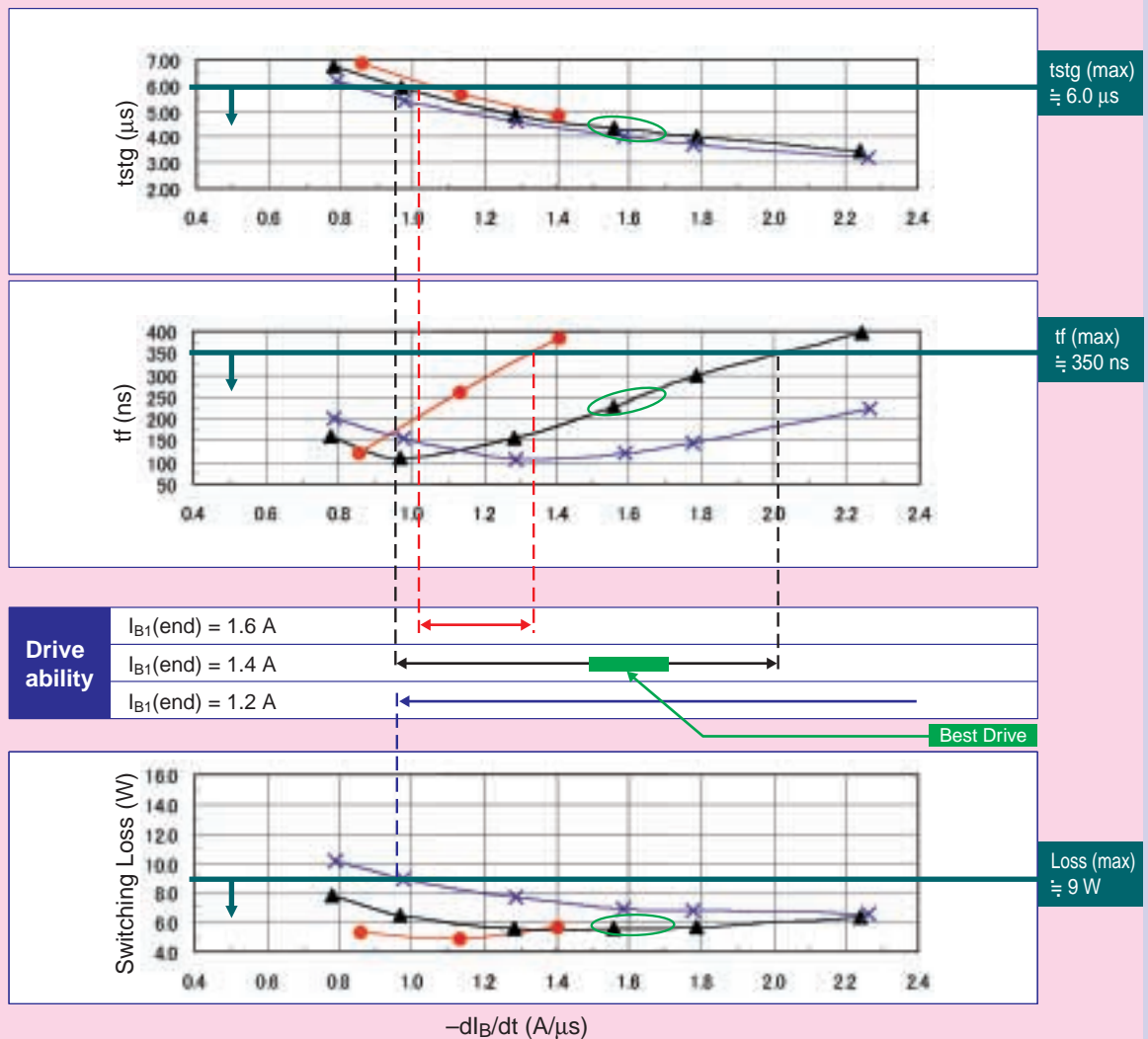

are  
=1.4A,  
1.6A/μs

Switching Loss ≈ 5.5W  
by hFE maximum side sample

# 14 Lead Formed Through-hole Packages

● TO-3P(H)IS

(Unit : mm)

**2-16E302A**

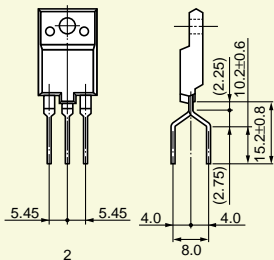

1. Base
2. Collector
3. Emitter

**2-16E303A**

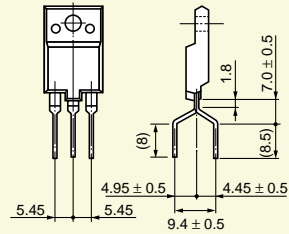

1. Base
2. Collector
3. Emitter

**2-16E305A**

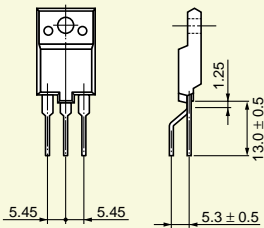

1. Base
2. Collector
3. Emitter

**2-16E306A**

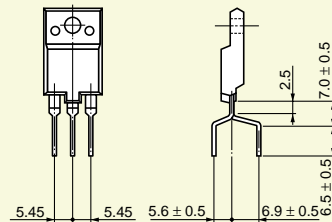

1. Base
2. Collector
3. Emitter

**2-16E307A**

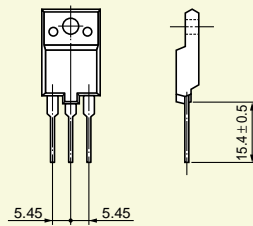

1. Base
2. Collector
3. Emitter

**2-16E309A**

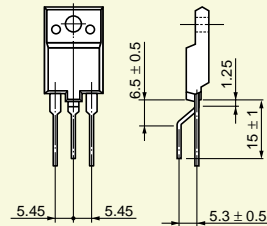

1. Base
2. Collector
3. Emitter

**2-16E311A**

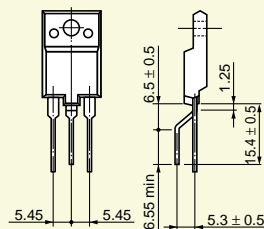

1. Base
2. Collector
3. Emitter

**2-16E313A**

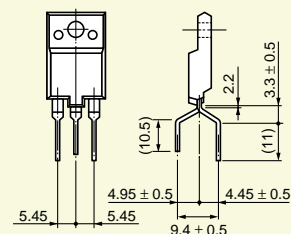

1. Base
2. Collector
3. Emitter



● TO-3P(H)IS

(Unit : mm)

2-16E314A

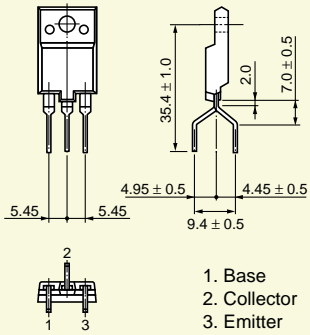

1. Base
2. Collector
3. Emitter

2-16E315A

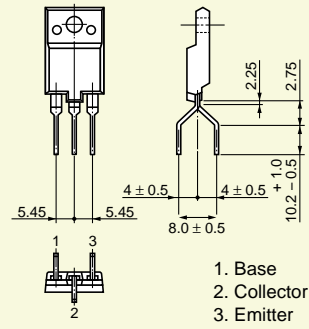

1. Base
2. Collector
3. Emitter

2-16E316A

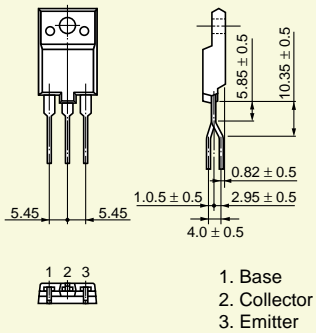

1. Base
2. Collector
3. Emitter

● TO-3P(LH)

(Unit : mm)

2-21F208A

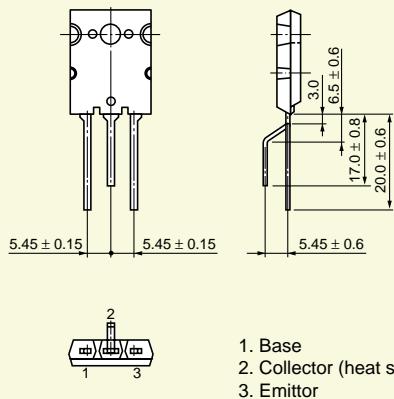

1. Base
2. Collector (heat sink)
3. Emitter

2-21F218A

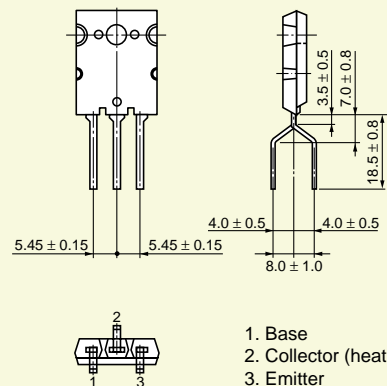

1. Base
2. Collector (heat sink)
3. Emitter

# 15 Markings

(As of September 2003)

## ● Explanation of markings

Toshiba horizontal-deflection output transistors are manufactured in Japan (at the Himeji Semiconductor Works) and in Malaysia (at Toshiba Electronics Malaysia Sdn. Bhd.). Toshiba Electronics Malaysia Sdn. Bhd. only manufactures TO-3P(H)IS products.

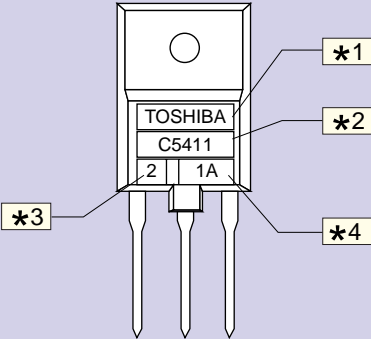
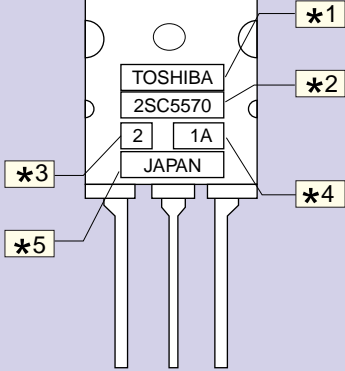
Place of Manufacture	TOSHIBA ELECTRONICS MALAYSIA SDN. BHD (made in Malaysia)	Himeji Semiconductor Works (made in Japan)
Package type	TO-3P(H)IS	TO-3P(LH)
Marking Type	Printing by white ink	Carving by laser
Marking Example		
Definition	<p>*1: Manufacturer's marking: "T", "T", "TOSHIBA"                  *2: Part number or abbreviated Part number                  *3: Division code: "1", "2", "3", "A", "B", "C" etc. Usually, no marking.                  *4: Lot number: month and year of manufacture                  Month of manufacture: January to December are denoted by the letters A to L respectively.                  Year of manufacture: last decimal digit of year of manufacture                  "1A", as shown on the above package, indicates manufacture in January 2001.                  *5: Country of origin                  Since TO-3P(LH) packages are only made in Japan, "JAPAN" is displayed.</p>	

# 16 Package Label

(As of September 2003)

## ● Sample label

P/N:			
TYPE			
ADDC		Q'TY	PCS.
NOTE			

  
 BARCORD

**TOSHIBA** MADE IN JAPAN

# 17 Package Specifications

(As of September 2003)

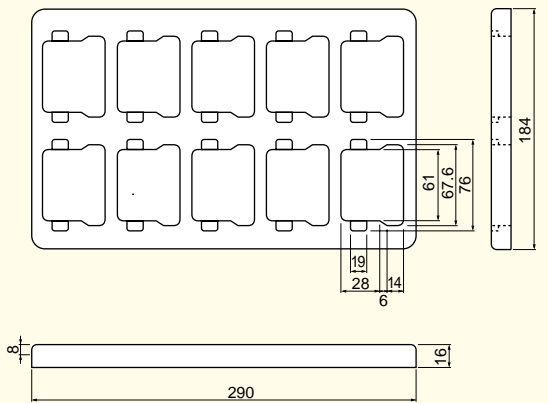
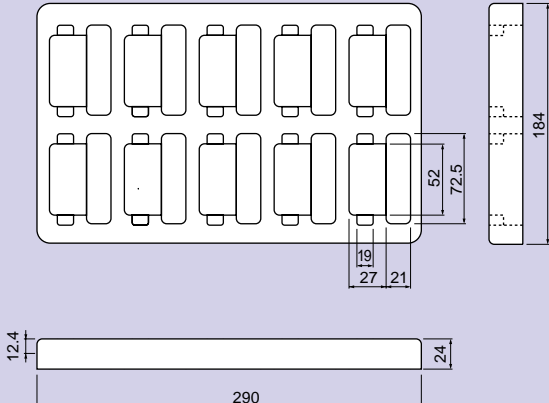
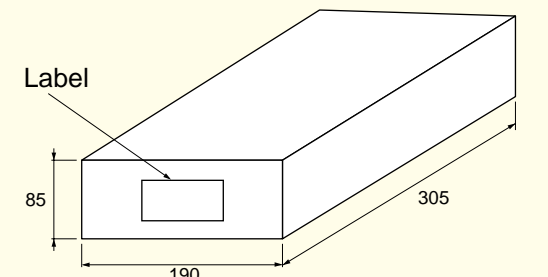
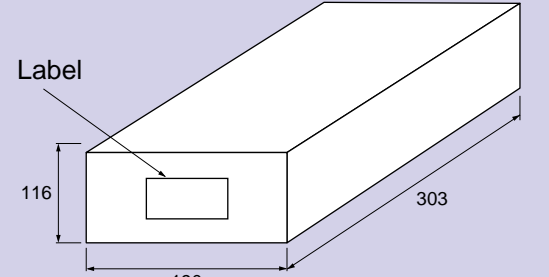
Package type	TO-3P(H)IS	TO-3P(LH)
Packing Type	100 per tray, 5 trays per carton	
Tray Dimensions (unit: mm)	<p>Tolerance: <math>\pm 0.7</math> Material: rigid vinyl chloride</p>  <p>Tray dimensions for TO-3P(H)IS: Overall length 290 mm, overall width 184 mm. Component dimensions include 61 mm, 67.6 mm, 76 mm, 19 mm, 28 mm, 14 mm, 6 mm, and 16 mm.</p>	<p>Tolerance: <math>\pm 0.7</math> Material: rigid vinyl chloride</p>  <p>Tray dimensions for TO-3P(LH): Overall length 290 mm, overall width 184 mm. Component dimensions include 52 mm, 72.5 mm, 19 mm, 27 mm, 21 mm, 12.4 mm, and 24 mm.</p>
Carton Dimensions (unit: mm)	 <p>Carton dimensions for TO-3P(H)IS: Height 85 mm, width 190 mm, length 305 mm. A label is indicated on the front face.</p>	 <p>Carton dimensions for TO-3P(LH): Height 116 mm, width 190 mm, length 303 mm. A label is indicated on the front face.</p>

# 18 List of Superseded, Final-Phase and Discontinued Products (As of September 2003)

## ① 2SC Series

Part Number	Super-seded Products	Final Phase Products	Discon- tinued Products	Maximum Ratings			Built-in damper diode	VCE(sat) (V)			Package Type				# Recommended Replacement and Remarks
				V <sub>CEO</sub> (V)	I <sub>C</sub> (A) (A)	P <sub>C</sub> (W)		Max (V)	@I <sub>C</sub> (sat) (A)	@I <sub>B</sub> (A)	(H)IS	(BS)	(LH)	TO-3	
2SC3715			✓	1500	4	50	✓	5	2.5	0.6	✓				2SD2599:②
2SC3716			✓	1500	5	50	✓	5	3	0.8	✓				2SD2599:①
2SC3884A			✓	1500	6	50		5	4	1	✓				2SC5855:②
2SC3885A			✓	1500	7	50		5	5	1.2	✓				2SC5855:②
2SC3886A			✓	1500	8	50		5	6	1.5	✓				2SC5855:②
2SC3887			✓	1400	6	80		5	4	1		✓			2SC5855:②⑤
2SC3887A			✓	1500	6	80		5	4	1		✓			2SC5855:②⑤
2SC3888			✓	1400	7	80		5	5	1.2		✓			2SC5855:②⑤
2SC3888A			✓	1500	7	80		5	5	1.2		✓			2SC5855:②⑤
2SC3889			✓	1400	8	80		5	6	1.5		✓			2SC5855:⑤
2SC3889A			✓	1500	8	80		5	6	1.5		✓			2SC5855:⑤
2SC3892			✓	1400	7	50	✓	5	5	1.2	✓				2SC5339:①
2SC3892A			✓	1500	7	50	✓	5	5	1.2	✓				2SC5339:①
2SC3893			✓	1400	8	50	✓	5	6	1.5	✓				2SC5280:①
2SC3893A			✓	1500	8	50	✓	5	6	1.5	✓				2SC5280:①
2SC4288			✓	1400	12	200		5	10	2.5			✓		2SC5589:②
2SC4288A			✓	1500	12	200		5	10	2.5			✓		2SC5589:②
2SC4289			✓	1400	16	200		5	12	3			✓		2SC5589:②
2SC4289A			✓	1500	16	200		5	12	3			✓		2SC5589:②
2SC4290			✓	1400	20	200		5	14	3.5			✓		2SC5589:②
2SC4290A			✓	1500	20	200		5	14	3.5			✓		2SC5589:②
2SC4531			✓	1500	10	50	✓	5	7	1.7	✓				2SC5280:②
2SC4532			✓	1700	10	200		5	8	2			✓		2SC5855:②⑤
2SC4542			✓	1500	10	50		5	7	1.7	✓				2SC5855:②
2SC4560			✓	1500	10	80		5	7	1.7		✓			2SC5855:②⑤
2SC4608			✓	1700	8	200		5	6	1.5			✓		2SC5855:②⑤
2SC4757			✓	1500	7	50		5	5	1.2	✓				2SC5855:②
2SC4758			✓	1500	8	50		5	6	1.5	✓				2SC5855:②
2SC4759			✓	1500	10	50		5	7	1.7	✓				2SC5855:②
2SC4760			✓	2000	8	200		5	6	1.5			✓		2SC5748:②
2SC4761			✓	1700	6	50		5	4.5	1.3	✓				2SC5588:③
2SC4762			✓	1500	7	50	✓	5	5	1	✓				2SC5339:②
2SC4763			✓	1500	8	50	✓	5	6	1.2	✓				2SC5280:②
2SC4764			✓	1500	6	50	✓	5	4	0.8	✓				2SC5339:②
2SC4765			✓	1700	5	50	✓	5	3.5	1	✓				2SC5716:②
2SC4766			✓	1700	6	50	✓	5	4.5	1.3	✓				2SC5716:②
2SC4806			✓	1700	5	50		5	3.5	1	✓				2SC5588:②
2SC4830			✓	1500	6	50		5	4	1	✓				2SC5855:②
2SC4916			✓	1500	7	50	✓	5	5	1	✓				2SC5339:①
2SC5048			✓	1500	12	50		3	8	2	✓				2SC5855:①
2SC5129			✓	1500	10	50		3	6	1.5	✓				2SC5855:②
2SC5142			✓	1500	20	200		3	14	3.5			✓		2SC5589:①
2SC5143			✓	1700	10	50	✓	3	6	1.5	✓				2SC5716:③
2SC5144		✓		1700	20	200		3	11	2.75			✓		2SC5858:①
2SC5148			✓	1500	12	50		5	5	1.3	✓				2SC5855:②
2SC5149			✓	1500	8	50	✓	5	5	1.3	✓				2SC5339:①
2SC5150			✓	1700	10	50		3	6	1.5	✓				2SC5588:②
2SC5331		✓		1500	15	180		3	9	2.25			✓		2SC5421:②
2SC5332			✓	1700	14	200		3	8	2			✓		2SC5590:②

# : Recommended replacement and remarks

- ① Electrical characteristics and packages are same.
- ② Electrical characteristics have a high grade.
- ③ Electrical characteristics are low grade.
- ④ Package (allowable power dissipation) is high grade.
- ⑤ Package (allowable power dissipation) is low grade.
- ⑥ Damper diode is built-in or not.

Notes:

- 2SC : 1st generation  
2SC : 2nd generation (final-phase or discontinued products.)  
2SC : 3rd generation (old design superseded products.)  
2SC : 4th generation (new design)  
2SC : 5th generation (the most new design)

① 2SD Series

Part Number	Super-seded Products	Final Phase Products	Discon- tinued Products	Maximum Ratings			Built-in damper diode	VCE(sat) (V)			Package Type				# Recommended Replacement and Remarks
				V <sub>CB0</sub> (V)	I <sub>c</sub> (A) (A)	P <sub>c</sub> (W)		MAX (V)	@I <sub>c</sub> (sat) (A)	@I <sub>B</sub> (A)	(H)IS	(BS)	(LH)	TO-3	
2SD811			✓	900	6	50		10	2.5	0.25				✓	2SC3657:⑤
2SD818			✓	1500	2.5	50		8	2	0.6				✓	2SD2599:⑤⑥
2SD819			✓	1500	3.5	50		8	3	0.8				✓	2SD2599:⑤⑥
2SD820			✓	1500	5	50		5	4	0.8				✓	2SC5855:②
2SD821			✓	1500	6	50		5	5	1				✓	2SC5855:②
2SD822			✓	1500	7	50		5	6	1.2				✓	2SC5855:②
2SD868			✓	1500	2.5	50	✓	8	2	0.6				✓	2SD2599:②⑤
2SD869			✓	1500	3.5	50	✓	8	3	0.8				✓	2SD2599:⑤
2SD870			✓	1500	5	50	✓	5	4	0.8				✓	2SD2499:①
2SD871			✓	1500	6	50	✓	5	5	1				✓	2SD2539:①
2SD1279			✓	1400	10	50		5	8	2				✓	2SC5855:①
2SD1425			✓	1500	2.5	80	✓	8	2	0.6		✓			2SD2599:②⑤
2SD1426			✓	1500	3.5	80	✓	8	3	0.8		✓			2SD2599:⑤
2SD1427			✓	1500	5	80	✓	5	4	0.8		✓			2SD2499:①⑤
2SD1428			✓	1500	6	80	✓	5	5	1		✓			2SD2539:⑤
2SD1429			✓	1500	2.5	80		8	2	0.6		✓			2SC5855:②⑤
2SD1430			✓	1500	3.5	80		8	3	0.8		✓			2SC5855:②⑤
2SD1431			✓	1500	5	80		5	4	0.8		✓			2SC5855:②⑤
2SD1432			✓	1500	6	80		5	5	1		✓			2SC5855:②⑤
2SD1433			✓	1500	7	80		5	6	1.2		✓			2SC5855:②⑤
2SD1543			✓	1500	2.5	40		8	2	0.6	✓				2SC5855:②
2SD1544			✓	1500	3.5	40		8	3	0.8	✓				2SC5855:②
2SD1545			✓	1500	5	50		5	4	0.8	✓				2SC5855:②
2SD1546			✓	1500	6	50		5	5	1	✓				2SC5855:②
2SD1547			✓	1500	7	50		5	6	1.2	✓				2SC5855:①
2SD1548			✓	1500	8	50		5	8	2	✓				2SC5855:②
2SD1553			✓	1500	2.5	40	✓	8	2	0.6	✓				2SD2599:②
2SD1554			✓	1500	3.5	40	✓	8	3	0.8	✓				2SD2599:①
2SD1555			✓	1500	5	50	✓	5	4	0.8	✓				2SD2499:②
2SD1556			✓	1500	6	50	✓	5	5	1	✓				2SD2539:①
2SD2089			✓	1500	3.5	40	✓	1	2.2	0.7	✓				2SD2599:①
2SD2095			✓	1500	5	50	✓	5	3.5	0.8	✓				2SD2586:①
2SD2125			✓	1500	6	50	✓	5	5	1	✓				2SD2539:①
2SD2253			✓	1700	6	50	✓	5	5	1	✓				2SD2638:①
2SD2348			✓	1500	8	50	✓	5	6	1.2	✓				2SD2559:③
2SD2349			✓	1500	10	50	✓	5	7	1.4	✓				2SD2559:③
2SD2428			✓	1700	8	200	✓	5	6	1.2			✓		2SD2553:⑤
2SD2454			✓	1700	7	50	✓	5	6	1.2	✓				2SC5716:①

① S2000 / S2055 Series

Part Number	Super-seded Products	Final Phase Products	Discon- tinued Products	Maximum Ratings			Built-in damper diode	VCE(sat) (V)			Package Type				# Recommended Replacement and Remarks
				V <sub>CB0</sub> (V)	I <sub>c</sub> (A) (A)	P <sub>c</sub> (W)		MAX (V)	@I <sub>c</sub> (sat) (A)	@I <sub>B</sub> (A)	(H)IS	(BS)	(LH)	TO-3	
S2000			✓	1500	5	80		5	4.5	2		✓			S2000N:②⑤
S2000A			✓	1500	5	80		1	4.5	2		✓			S2000N:⑤
S2000AF			✓	1500	5	50		1	4.5	2	✓				S2000N:①
S2000F			✓	1500	5	50		5	4.5	2	✓				S2000N:②
S2055			✓	1500	5	80	✓	5	4.5	2		✓			S2055N:②⑤
S2055A			✓	1500	5	80	✓	1	4.5	2		✓			S2055N:⑤
S2055AF			✓	1500	5	50	✓	1	4.5	2	✓				S2055N:①
S2055F			✓	1500	5	50	✓	5	4.5	2	✓				S2055N:②

# : Recommended replacement and remarks

Notes:

- ① Electrical characteristics and packages are same.
- ② Electrical characteristics have are high grade.
- ③ Electrical characteristics are low grade.
- ④ Package (allowable power dissipation) is high grade.
- ⑤ Package (allowable power dissipation) is low grade.
- ⑥ Damper diode is built-in or not.

- 2SC : 1st generation
- 2SD : 2nd generation (final-phase or discontinued products.)
- 2SC : 3rd generation (old design superseded products.)
- 2SC : 4th generation (new design)
- 2SC : 5th generation (the most new design)

# 19 Replacement Table from Old Device to New Device by Ic(sat) (As of September 2003)

V <sub>сво</sub> = *900 V, ♦1400 V, 1500 V							
Package	TO-3P(H)IS		TO-3		TO-3P(BS)		TO-3P(LH)
Pc max	40 W to 75 W		50 W		80 W		180 W - 220 W
** Ic(sat)	Built-in damper diode	Not built-in damper diode	Built-in damper diode	Not built-in damper diode	Built-in damper diode	Not built-in damper diode	Not built-in damper diode
2 A	2SC3715 (5 V) 2SD1553 (8 V)	2SD1543 (8 V)	2SD868 (8 V)	2SD818 (8 V)	2SD1425 (8 V)	2SD1429 (8 V)	
2.2 A	2SD2089 (1 V)						
2.5 A	2SC3715 (5 V)			*2SD811 (10 V)			
3 A	2SC3716 (5 V) 2SD1554 (8 V) 2SD2599 (8 V)	2SD1544 (8 V)	2SD869 (8 V)	2SD819 (8 V)	2SD1426 (8 V)	2SD1430 (8 V)	
3.5 A	2SD2095 (5V) 2SD2586 (5 V)						
4 A	2SC4764 (5 V) 2SD1555 (5 V) 2SD2499 (5 V)	2SC3884A (5 V) 2SC4830 (5 V) 2SD1545 (5 V) 2SD2498 (5 V)	2SD870 (5 V)	2SD820 (5 V)	2SD1427 (5 V)	♦2SC3887 (5 V) 2SC3887A (5 V) 2SD1431 (5 V)	
4.5 A	S2055AF (1 V) S2055F (5 V) S2055N (5V)	S2000AF (1 V) S2000F (5 V) S2000N (5 V)			S2055 (5 V) S2055A (1 V)	S2000 (5 V) S2000A (1 V)	
5 A	2SC4762 (5 V) 2SC4916 (5 V) 2SC5149 (5 V) 2SC5339 (5 V) 2SD1556 (5 V) 2SD2125 (5 V) 2SD2539 (5 V)	2SC3885A (5 V) 2SC4757 (5 V) 2SC5148 (3 V) 2SD1546 (5 V)	2SD871 (5 V)	2SD821 (5 V)	♦2SC3892 (5 V) 2SC3892A (5 V) 2SD1429 (5 V)	♦2SC3888 (5 V) 2SC3888A (5 V) 2SD1432 (5 V)	
5.5 A							
6 A	2SC4763 (5 V) 2SC5280 (5 V) 2SD2348 (5 V) 2SD2559 (5 V)	2SC3886A (5 V) 2SC4758 (5 V) 2SC5129 (3 V) 2SD1547 (5 V) 2SD2500 (3 V)		2SD822 (5 V)	♦2SC3893 (5 V) 2SC3893A (5 V)	♦2SC3889 (5 V) 2SC3889A (5 V) 2SD1433 (5 V)	
7 A	2SC4531 (5 V) 2SD2349 (5 V)	2SC4542 (5 V) 2SC4759 (5 V) 2SC5404 (3 V)				2SC4560 (5 V)	
8 A	* S3H58 (3 V)	2SD1548 (5 V) 2SC5048 (3 V) 2SC5387 (3 V) 2SC5855 (3 V)		♦2SD1279 (5 V)			
9 A							2SC5331
10 A							♦2SC4288 (5 V) 2SC4288A (5 V)
11 A		2SC5411 (3 V) 2SC5856 (3 V)					2SC5421 (3 V)
12 A							♦2SC4289 (5 V) 2SC4289A (5 V)
14 A		2SC5587 (3 V) * S3G90 (3 V)					♦2SC4290 (5 V) 2SC4290A (5 V) 2SC5142 (3 V) 2SC5589 (3 V)
15 A							2SC5445 (3 V)
17 A		2SC5717 (3 V)					2SC5695 (3 V)
18 A							
22 A							

Note :

**2SC** : Superseded, final-phase or discontinued products.

**2SC** : 3rd generation (old design).

**2SC** : 4th generation

**2SC** : 5th generation ( the most new design)

\* : Under development and tentative specs.

\*\* : Ic(sat) is value of Ic for V<sub>CE(sat)</sub>.

(5 V) means V<sub>CE(sat)</sub> = 5 V

V <sub>сво</sub> = 1700 V			V <sub>сво</sub> = 2000 V			
TO-3P(H)IS		TO-3P(LH)	TO-3P(H)IS		TO-3P(LH)	Package
40 W - 75 W		180 W - 220 W	40 W - 75 W		180 W - 220 W	Pc max
Built-in damper diode	Not built-in damper diode	Not built-in damper diode	Built-in damper diode	Not built-in damper diode	Not built-in damper diode	** I <sub>c(sat)</sub>
						2 A
						2.2 A
						2.5 A
<b>2SD2550 (5 V)</b>						3 A
<b>2SC4765 (5 V)</b>	<b>2SC4806 (5 V)</b>					3.5 A
<b>2SD2551 (5 V)</b>						4 A
<b>2SC4766 (5 V)</b>	<b>2SC4761 (5 V)</b>					4.5 A
<b>2SD2253 (5 V)</b>						5 A
<b>2SD2638 (5 V)</b>						5.5 A
<b>2SC5143 (3 V)</b>	<b>2SC5150 (3 V)</b>	<b>2SC4608 (5 V)</b>			<b>2SC4760 (5 V)</b>	6 A
<b>2SC5716 (5 V)</b>						
<b>2SD2428 (5 V)</b>						
<b>2SD2454 (5 V)</b>						
<b>2SD2553 (5 V)</b>						
						7 A
		<b>2SC4532 (5 V)</b> <b>2SC5332 (3 V)</b>	<b>* S3H60 (3 V)</b>			8 A
						9 A
						10 A
		<b>2SC5144 (3 V)</b> <b>2SC5422 (3 V)</b>		<b>* 2SC5997 (1.5V)</b>		11 A
<b>* S3G18 (3 V)</b>	<b>2SC5588 (3 V)</b>	<b>2SC5590 (3 V)</b>				12 A
		<b>2SC5446 (3 V)</b>			<b>2SC5748 (3 V)</b>	14 A
						15 A
	<b>2SC5857 (1.5 V)</b>	<b>2SC5858 (1.5 V)</b>			<b>2SC5612 (3 V)</b>	17 A
		<b>2SC5859 (3 V)</b>				18 A
		<b>2SC5570 (3 V)</b>				22 A

## OVERSEAS SUBSIDIARIES AND AFFILIATES

### Toshiba America Electronic Components, Inc.

**Headquarters-Irvine, CA**  
9775 Toledo Way, Irvine, CA 92618, U.S.A.  
Tel: (949)455-2000 Fax: (949)859-3963

**Boulder, CO (Denver)**  
3100 Araphahoe #500,  
Boulder, CO 80303, U.S.A.  
Tel: (303)442-3801 Fax: (303)442-7216

**Wellington**  
PBM 337, #22, 11924 Forest Hill Blvd.,  
Wellington, FL 33414, U.S.A.  
Tel: (561)733-4949 Fax: (561)753-1489

**Deerfield, IL (Chicago)**  
One Pkwy., North, #500, Deerfield,  
IL 60015-2547, U.S.A.  
Tel: (847)945-1500 Fax: (847)945-1044

**Duluth, GA (Atlanta)**  
3700 Crestwood Pkwy, #160,  
Duluth, GA 30096, U.S.A.  
Tel: (770)931-3363 Fax: (770)931-7602

**Edison, NJ**  
2035 Lincoln Hwy, #3000, Edison,  
NJ 08817, U.S.A.  
Tel: (732)248-8070 Fax: (732)248-8030

**Beaverton/Portland, OR**  
1700 NW 167th Place, #240,  
Beaverton, OR 97006, U.S.A.  
Tel: (503)629-0818 Fax: (503)629-0827

**Raleigh, NC**  
3120 Highwoods Blvd., #108, Raleigh,  
NC 27604, U.S.A.  
Tel: (919)859-2800 Fax: (919)859-2898

**Richardson, TX (Dallas)**  
777 East Campbell Rd., #650, Richardson,  
TX 75081, U.S.A.  
Tel: (972)480-0470 Fax: (972)235-4114

**San Jose Engineering Center, CA**  
1060 Rincon Circle, San Jose, CA 95131, U.S.A.  
Tel: (408)526-2400 Fax: (408)526-8910

**Wakefield, MA (Boston)**  
401 Edgewater Place, #360, Wakefield,  
MA 01880-6229, U.S.A.  
Tel: (781)224-0074 Fax: (781)224-1095

**Toshiba do Brasil, S.A.**  
**Electronics Component Div.**  
Rua Afonso Celso, 552 3° and CEP 04119-002  
Vila Mariana-São Paulo-SP, Brasil  
Tel: (011)5576-6619 Fax: (011)5576-6607

**Toshiba India Private Ltd.**  
6F DR. Gopal Das Bhawan 28, Barakhamba Road,  
New Delhi, India  
Tel: (011)331-8422 Fax: (011)371-4603

**Toshiba Electronics Europe GmbH**  
**Düsseldorf Head Office**  
Hansaallee 181, D-40549 Düsseldorf,  
Germany  
Tel: (0211)5296-0 Fax: (0211)5296-400

**München Office**  
Büro München Hofmannstrasse 52,  
D-81379, München, Germany  
Tel: (089)748595-0 Fax: (089)748595-42

**Toshiba Electronics France S.A.R.L.**  
Immeuble Robert Schuman 3 Rue de Rome  
F-93561, Rosny-Sous-Bois, Cédex, France  
Tel: (1)48-12-48-12 Fax: (1)48-94-51-15

**Toshiba Electronics Italiana S.R.L.**  
Centro Direzionale Colleoni,  
Palazzo Perseo 3,  
I-20041 Agrate Brianza, (Milan), Italy  
Tel: (039)68701 Fax: (039)6870205

**Toshiba Electronics España, S.A.**  
Parque Empresarial, San Fernando, Edificio Europa,  
1ª Planta, E-28831 Madrid, Spain  
Tel: (91)660-6798 Fax: (91)660-6799

**Toshiba Electronics (UK) Ltd.**  
Riverside Way, Camberley Surrey,  
GU15 3YA, U.K.  
Tel: (01276)69-4600 Fax: (01276)69-4800

**Toshiba Electronics Scandinavia A.B.**  
Gustavslundsvägen 18, 5th Floor,  
S-167 15 Bromma, Sweden  
Tel: (08)704-0900 Fax: (08)80-8459

### Toshiba Electronics Asia (Singapore) Pte. Ltd.

**Singapore Head Office**  
438B Alexandra Road, #06-08/12 Alexandra  
Technopark, Singapore 119968  
Tel: (6278)5252 Fax: (6271)5155

**Toshiba Electronics Service  
(Thailand) Co., Ltd.**  
135 Moo 5, Bangkadi Industrial Park, Tivanon Road,  
Pathumthani, 12000, Thailand  
Tel: (02)501-1635 Fax: (02)501-1638

### Toshiba Electronics Trading (Malaysia) Sdn. Bhd.

**Kuala Lumpur Head Office**  
Suite W1203, Wisma Consplant, No.2,  
Jalan SS 16/4, Subang Jaya, 47500 Petaling Jaya,  
Selangor Darul Ehsan, Malaysia  
Tel: (03)5631-6311 Fax: (03)5631-6307

**Penang Office**  
Suite 13-1, 13th Floor, Menara Penang Garden,  
42-A, Jalan Sultan Ahmad Shah,  
10050 Penang, Malaysia  
Tel: (04)226-8523 Fax: (04)226-8515

**Toshiba Electronics Philippines, Inc.**  
26th Floor, Citibank Tower, Valero Street, Makati,  
Manila, Philippines  
Tel: (02)750-5510 Fax: (02)750-5511

**Toshiba Electronics Asia, Ltd.**  
**Hong Kong Head Office**  
Level 11, Tower 2, Grand Century  
Place, No.193, Prince Edward Road West,  
Mongkok, Kowloon, Hong Kong  
Tel: 2375-6111 Fax: 2375-0969

**Beijing Office**  
Room 714, Beijing Fortune Building,  
No.5 Dong San Huan Bei-Lu, Chao Yang District,  
Beijing, 100004, China  
Tel: (010)6590-8796 Fax: (010)6590-8791

**Chengdu Office**  
Suite 403A, Holiday Inn Crown Plaza 31, Zongfu Street,  
Chengdu, 610016, Sichuan, China  
Tel: (028)8675-1773 Fax: (028)8675-1065

**Shenzhen Office**  
Room 3010-3013, Office Tower Shun Hing Square,  
Di Wang Commercial Centre, 5002 ShenNan  
East Road, Shenzhen, 518008, China  
Tel: (0755)246-3218 Fax: (0755)246-1581

**Qingdao Office**  
Room B707, Full Hope Plaza,  
12 Hong Kong Central Road, Qingdao,  
Shandong, 266071, China  
Tel: (0532)502-8105 Fax: (0532)502-8109

**Toshiba Electronics Korea Corporation**  
**Seoul Head Office**  
14F, KEC Building, 275-7 Yangjae-dong,  
Seocho-ku, Seoul, 137-739, Korea  
Tel: (02)589-4334 Fax: (02)589-4302

**Gumi Office**  
6F, Goodmorning Securities Building,  
56 Songjung-dong, Gumi-shi,  
Kyeongsbuk, 730-090, Korea  
Tel: (054)456-7613 Fax: (054)456-7617

**Toshiba Electronics (Shanghai) Co., Ltd.**  
23F, HSBC Tower, 101  
Yin Cheng East Road, Pudong New Area, Shanghai,  
200120, China  
Tel: (021)6841-0666 Fax: (021)6841-5002

**Tsurong Xiamen Xiangyu Trading  
Co., Ltd.**  
8N, Xiamen SEZ Bonded Goods Market Building,  
Xiamen, Fujian, 361006, China  
Tel: (0592)562-3798 Fax: (0592)562-3799

**Toshiba Electronics Taiwan  
Corporation**  
**Taipei Head Office**  
17F, Union Enterprise Plaza Building, 109  
Min Sheng East Road, Section 3, Taipei,  
105, Taiwan  
Tel: (02)2514-9988 Fax: (02)2514-7892

**Kaohsiung Office**  
16F-A, Chung-Cheng Building, 2, Chung-Cheng 3Road,  
Kaohsiung, 800, Taiwan  
Tel: (07)237-0826 Fax: (07)236-0046

(As of April 1, 2003)

The information contained herein is subject to change without notice. 021023\_D

The information contained herein is presented only as a guide for the applications of our products. No responsibility is assumed by TOSHIBA for any infringements of patents or other rights of the third parties which may result from its use. No license is granted by implication or otherwise under any patent or patent rights of TOSHIBA or others. 021023\_C

TOSHIBA is continually working to improve the quality and reliability of its products. Nevertheless, semiconductor devices in general can malfunction or fail due to their inherent electrical sensitivity and vulnerability to physical stress. It is the responsibility of the buyer, when utilizing TOSHIBA products, to comply with the standards of safety in making a safe design for the entire system, and to avoid situations in which a malfunction or failure of such TOSHIBA products could cause loss of human life, bodily injury or damage to property.

In developing your designs, please ensure that TOSHIBA products are used within specified operating ranges as set forth in the most recent TOSHIBA products specifications. Also, please keep in mind the precautions and conditions set forth in the "Handling Guide for Semiconductor Devices," or "TOSHIBA Semiconductor Reliability Handbook" etc. 021023\_A

The Toshiba products listed in this document are intended for usage in general electronics applications (computer, personal equipment, office equipment, measuring equipment, industrial robotics, domestic appliances, etc.). These Toshiba products are neither intended nor warranted for usage in equipment that requires extraordinarily high quality and/or reliability or a malfunction or failure of which may cause loss of human life or bodily injury ("Unintended Usage"). Unintended Usage include atomic energy control instruments, airplane or spaceship instruments, transportation instruments, traffic signal instruments, combustion control instruments, medical instruments, all types of safety devices, etc. Unintended Usage of Toshiba products listed in this document shall be made at the customer's own risk. 021023\_B

TOSHIBA products should not be embedded to the downstream products which are prohibited to be produced and sold, under any law and regulations. 030519\_C

# TOSHIBA

**TOSHIBA CORPORATION**  
**Semiconductor Company**

Website: <http://www.semicon.toshiba.co.jp/eng>