

lenovo

Lenovo Yoga 2 Pro

13 inch Display

*Hardware
Maintenance
Manual*

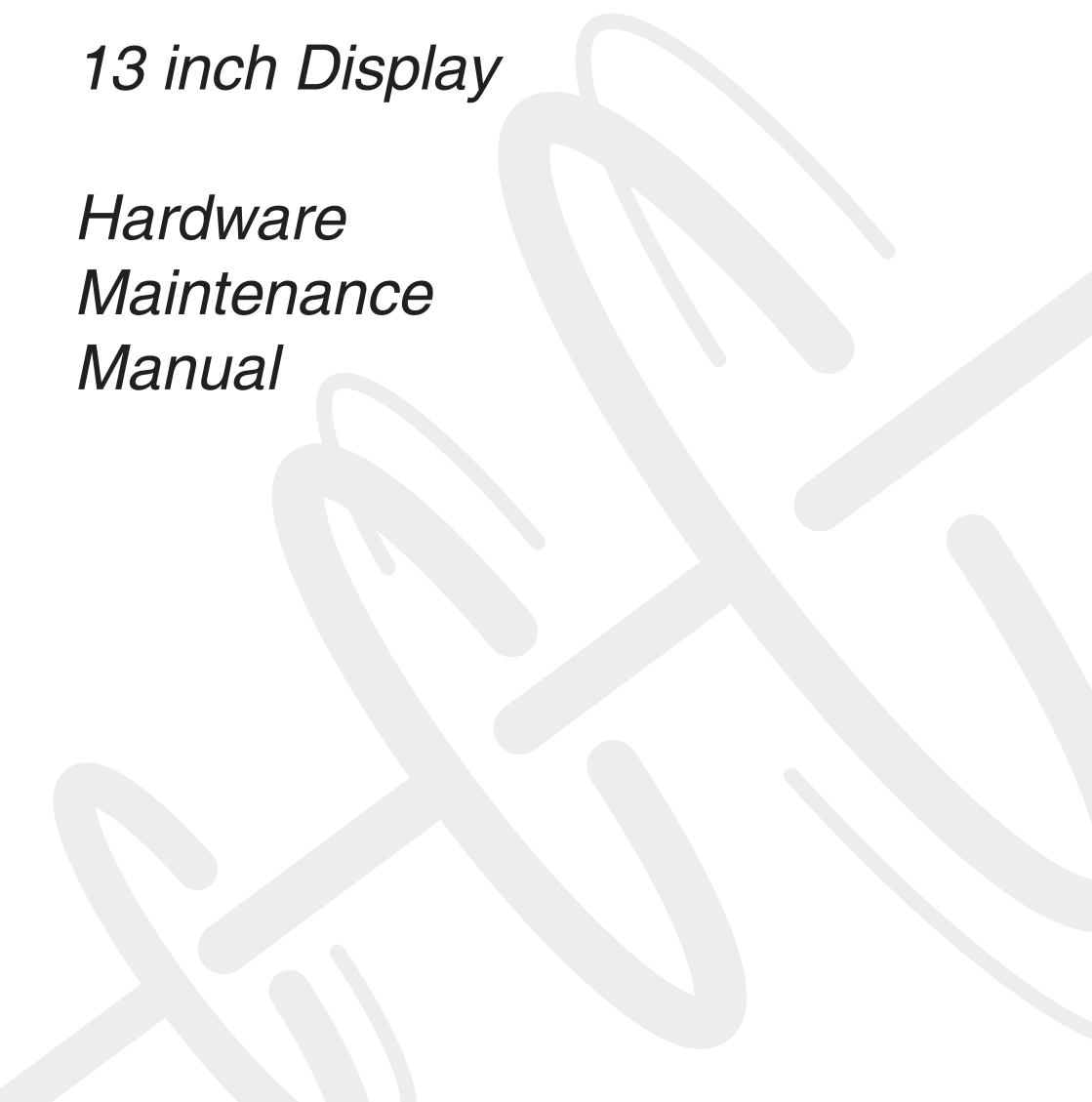

Notes:

- Before using this information and the product it supports, be sure to read the general information under “Notices” on page 71.

First Edition (Sep. 2013)

© Copyright Lenovo 2013. All rights reserved.

LIMITED AND RESTRICTED RIGHTS NOTICE: If data or software is delivered pursuant a General Services Administration “GSA” contract, use, reproduction, or disclosure is subject to restrictions set forth in Contract No. GS-35F-05925.

© 2013 Lenovo

Contents

About this manual	iv	1050 Fan assembly and heat sink assembly	41
Safety information	1	1060 PCI Express Mini Card for wireless LAN	43
General safety	2	1070 Solid state disk	44
Electrical safety	3	1080 Audio board and SSD board	45
Safety inspection guide	5	1090 Keyboard bezel	46
Handling devices that are sensitive to electrostatic discharge	6	1100 Keyboard	48
Grounding requirements	6	1110 LCD front cover	50
Safety notices: multilingual translations	7	1120 MIC board, LCD cover, and hinges	52
Laser compliance statement	14	1130 LCD module	55
Important service information	16	Locations	58
Strategy for replacing FRUs	16	Front view and right-side view	58
Strategy for replacing a hard disk drive	17	Bottom and Left-side view	59
Important notice for replacing a system board	17	Parts list	60
Important information about replacing RoHS compliant FRUs	18	Overall	61
General checkout	19	LCD FRUs	63
What to do first	20	Keyboard	65
Power system checkout	21	Miscellaneous parts	67
Checking the AC adapter	21	Screw	67
Checking operational charging	21	AC adapters	68
Checking power button	21	Power cords	69
Related service information	23	Notices	71
Restoring the factory contents by using OneKey Recovery	23	Trademarks	72
Restore of factory default	23		
Passwords	24		
Power-on password	24		
Hard-disk password	24		
Supervisor password	24		
Power management	25		
Screen blank state	25		
Putting the computer to sleep or shutting it down	25		
Putting your computer to sleep	25		
Shutting down the computer	26		
Lenovo Yoga 2 Pro (13")	27		
Specifications	27		
Status indicators	29		
Fn key combinations	30		
FRU replacement notices	31		
Screw notices	31		
Removing and replacing an FRU	32		
1010 Base cover	33		
1020 Battery pack	35		
1030 LCD unit	36		
1040 System board	38		

About this manual

This manual contains service and reference information for the following Lenovo product:

Lenovo Yoga 2 Pro (13")

Use this manual to troubleshoot problems.

The manual is divided into the following sections:

- The common sections provide general information, guidelines, and safety information required for servicing computers.
- The product-specific section includes service, reference, and product-specific parts information.

Important:

This manual is intended only for trained servicers who are familiar with Lenovo products. Use this manual to troubleshoot problems effectively.

Before servicing a Lenovo product, make sure to read all the information under "Safety information" on page 1 and "Important service information" on page 16.

Safety information

This chapter presents the following safety information that you need to get familiar with before you service a Lenovo Yoga 2 Pro (13") computer:

- "General safety" on page 2
- "Electrical safety" on page 3
- "Safety inspection guide" on page 5
- "Handling devices that are sensitive to electrostatic discharge" on page 6
- "Grounding requirements" on page 6
- "Safety notices: multilingual translations" on page 7
- "Laser compliance statement" on page 14

General safety

Follow these rules below to ensure general safety:

- Observe a good housekeeping in the area where the machines are put during and after the maintenance.
- When lifting any heavy object:
 1. Make sure that you can stand safely without slipping.
 2. Distribute the weight of the object equally between your feet.
 3. Use a slow lifting force. Never move suddenly or twist when you attempt to lift it.
 4. Lift it by standing or pushing up with your leg muscles; this action could avoid the strain from the muscles in your back. Do not attempt to lift any object that weighs more than 16 kg (35 lb) or that you think is too heavy for you.
- Do not perform any action that causes hazards to the customer, or that makes the machine unsafe.
- Before you start the machine, make sure that other service representatives and the customer are not in a hazardous position.
- Please remove covers and other parts in a safe place, away from all personnel, while you are servicing the machine.
- Keep your toolcase away from walk areas so that other people will not trip over it.
- Do not wear loose clothing that can be trapped in the moving parts of the machine. Make sure that your sleeves are fastened or rolled up above your elbows. If your hair is long, fasten it.
- Insert the ends of your necktie or scarf inside clothing or fasten it with the nonconductive clip, about 8 centimeters (3 inches) from the end.
- Do not wear jewelry, chains, metal-frame eyeglasses, or metal fasteners for your clothing.

Attention: Metal objects are good electrical conductors.
- Wear safety glasses when you are hammering, drilling, soldering, cutting wire, attaching springs, using solvents, or working in any other conditions that may be hazardous to your eyes.
- After service, reinstall all safety shields, guards, labels, and ground wires. Replace any safety device that is worn or defective.
- Reinstall all covers correctly before returning the machine to the customer.
- Fan louvers on the machine help to prevent the overheating of internal components. Do not obstruct fan louvers or cover them with labels or stickers.

Electrical safety

Observe the following rules when working on electrical equipments.

Important:

Use only approved tools and test equipments. Some hand tools have handles covered with a soft material that does not insulate you when working with live electrical currents.

Many customers have rubber floor mats near their machines that contain small conductive fibers to decrease electrostatic discharges. Do not use such kind of mat to protect yourself from electrical shock.

- Find the room emergency power-off (EPO) switch, disconnecting switch or electrical outlet. If an electrical accident occurs, you can then operate the switch or unplug the power cord quickly.
- Do not work alone under hazardous conditions or near the equipment that has hazardous voltages.
- Disconnect all power before:
 - Performing a mechanical inspection
 - Working near power supplies
 - Removing or installing main units
- Before you start to work on the machine, unplug the power cord. If you cannot unplug it, ask the customer to power-off the wall box that supplies power to the machine, and to lock the wall box in the off position.
- If you need to work on a machine that has exposed electrical circuits, observe the following precautions:
 - Ensure that another person, familiar with the power-off controls, is near you.

Attention: Another person must be there to switch off the power, if necessary.
 - Use only one hand when working with powered-on electrical equipment; keep the other hand in your pocket or behind your back.

Attention: An electrical shock can occur only when there is a complete circuit. By observing the above rule, you may prevent a current from passing through your body.
 - When using testers, set the controls correctly and use the approved probe leads and accessories for that tester.
 - Stand on suitable rubber mats (obtained locally, if necessary) to insulate you from grounds such as metal floor strips and machine frames.

Observe the special safety precautions when you work with very high voltages; instructions for these precautions are in the safety sections of maintenance information. Be extremely careful when you measure the high voltages.

- Regularly inspect and maintain your electrical hand tools for safe operational condition.
- Do not use worn or broken tools and testers.
- Never assume that power has been disconnected from a circuit. First, check it to make sure that it has been powered off.

- Always look carefully for possible hazards in your work area. Examples of these hazards are moist floors, nongrounded power extension cables, power surges, and missing safety grounds.
- Do not touch live electrical circuits with the reflective surface of a plastic dental mirror. The surface is conductive; such touching can cause personal injury and machine damage.
- Do not service the following parts with the power on when they are removed from their normal operating places in a machine:
 - Power supply units
 - Pumps
 - Blowers and fans
 - Motor generatorsand similar units. (This practice ensures correct grounding of the units.)
- If an electrical accident occurs:
 - Caution: do not become a victim yourself.
 - Switch off the power.
 - Send the victim to get medical aid.

Safety inspection guide

The purpose of this inspection guide is to assist you in identifying potential unsafe conditions. As each machine was designed and built, required safety items were installed to protect users and service personnel from injury. This guide addresses only those items. You should use good judgment to identify potential safety hazards according to the attachment of non-Lenovo features or options not covered by this inspection guide.

If any unsafe conditions are present, you must determine how serious the apparent hazard could be and whether you can continue without first correcting the problem.

Consider these conditions and the safety hazards they present:

- Electrical hazards, especially primary power (primary voltage on the frame can cause serious or fatal electrical shock)
- Explosive hazards, such as a damaged CRT face or a bulging capacitor
- Mechanical hazards, such as loose or missing hardware

To determine whether there are any potential unsafe conditions, use the following checklist at the beginning of every service task. Begin the checks with the power off, and the power cord disconnected.

Checklist:

1. Check exterior covers for damage (loose, broken, or sharp edges).
2. Turn off the computer. Disconnect the power cord.
3. Check the power cord for:
 - a. A third-wire ground connector in good condition. Use a meter to measure third-wire ground continuity for 0.1 ohm or less between the external ground pin and the frame ground.
 - b. The power cord should be the type specified in the parts list.
 - c. Insulation must not be frayed or worn.
4. Check for cracked or bulging batteries.
5. Remove the cover.
6. Check for any obvious non-Lenovo alterations. Use good judgment as to the safety of any non-Lenovo alterations.
7. Check inside the unit for any obvious unsafe conditions, such as metal filings, contamination, water or other liquids, or signs of fire or smoke damage.
8. Check for worn, frayed, or pinched cables.
9. Check that the power-supply cover fasteners (screws or rivets) have not been removed or tampered with.

Handling devices that are sensitive to electrostatic discharge

Any computer part containing transistors or integrated circuits (ICs) should be considered sensitive to electrostatic discharge (ESD). ESD damage can occur when there is a difference in charge between objects. Protect against ESD damage by equalizing the charge so that the machine, the part, the work mat, and the person handling the part are all at the same charge.

Notes:

1. Use product-specific ESD procedures when they exceed the requirements noted here.
2. Make sure that the ESD protective devices you use have been certified (ISO 9000) as fully effective.

When handling ESD-sensitive parts:

- Keep the parts in protective packages until they are inserted into the product.
- Avoid contact with other people.
- Wear a grounded wrist strap against your skin to eliminate static on your body.
- Prevent the part from touching your clothing. Most clothing is insulative and retains a charge even when you are wearing a wrist strap.
- Use the black side of a grounded work mat to provide a static-free work surface. The mat is especially useful when handling ESD-sensitive devices.
- Select a grounding system, such as those listed below, to provide protection that meets the specific service requirement.

Note:

The use of a grounding system to guard against ESD damage is desirable but not necessary.

- Attach the ESD ground clip to any frame ground, ground braid, or green-wire ground.
- When working on a double-insulated or battery-operated system, use an ESD common ground or reference point. You can use coax or connector-outside shells on these systems.
- Use the round ground prong of the ac plug on ac-operated computers.

Grounding requirements

Electrical grounding of the computer is required for operator safety and correct system function. Proper grounding of the electrical outlet can be verified by a certified electrician.

Safety notices: multilingual translations

The safety notices in this section are provided in English, French, German, Hebrew, Italian, Japanese, and Spanish.

Safety notice 1

Before the computer is powered on after FRU replacement, make sure all screws, springs, and other small parts are in place and are not left loose inside the computer. Verify this by shaking the computer and listening for rattling sounds. Metallic parts or metal flakes can cause electrical shorts.

Avant de remettre l'ordinateur sous tension après remplacement d'une unité en clientèle, vérifiez que tous les ressorts, vis et autres pièces sont bien en place et bien fixées. Pour ce faire, secouez l'unité et assurez-vous qu'aucun bruit suspect ne se produit. Des pièces métalliques ou des copeaux de métal pourraient causer un court-circuit.

Bevor nach einem FRU-Austausch der Computer wieder angeschlossen wird, muß sichergestellt werden, daß keine Schrauben, Federn oder andere Kleinteile fehlen oder im Gehäuse vergessen wurden. Der Computer muß geschüttelt und auf Klappergeräusche geprüft werden. Metallteile oder-splitter können Kurzschlüsse erzeugen.

לפני הפעלת המחשב לאחר החלפת FRU יש לוודא שכל הברגים, הקפיצים, וחלקים קטנים אחרים נמצאים במקומם ואינם חופשיים לזוז בתוך המחשב. כדי לוודא זאת, יש ללטלט את המחשב ולהקשיב לגילוי קולות שקשוק. חלקי או שבבי מתכת עלולים לגרום לקצרים חשמליים.

Prima di accendere l'elaboratore dopo che é stata effettuata la sostituzione di una FRU, accertarsi che tutte le viti, le molle e tutte le altri parti di piccole dimensioni siano nella corretta posizione e non siano sparse all'interno dell'elaboratore. Verificare ciò scuotendo l'elaboratore e prestando attenzione ad eventuali rumori; eventuali parti o pezzetti metallici possono provocare cortocircuiti pericolosi.

FRUの交換後、コンピュータの電源を入れる前に、ねじ、バネ、その他の小さな部品がすべて正しい位置にあり、またコンピュータの内部で緩んでいないことを確認してください。これを確認するには、コンピュータを振って、カチャカチャと音がしないか確かめます。金属部品や金属破片はショートの原因になることがあります。

Antes de encender el sistema despues de sustituir una FRU, compruebe que todos los tornillos, muelles y demás piezas pequeñas se encuentran en su sitio y no se encuentran sueltas dentro del sistema. Compruébelo agitando el sistema y escuchando los posibles ruidos que provocarían. Las piezas metálicas pueden causar cortocircuitos eléctricos.

Safety notice 2

DANGER

Some standby batteries contain a small amount of nickel and cadmium. Do not disassemble a standby battery, recharge it, throw it into fire or water, or short-circuit it. Dispose of the battery as required by local ordinances or regulations. Use only the battery in the appropriate parts listing. Use of an incorrect battery can result in ignition or explosion of the battery.

Certaines batteries de secours contiennent du nickel et du cadmium. Ne les démontez pas, ne les rechargez pas, ne les exposez ni au feu ni à l'eau. Ne les mettez pas en court-circuit. Pour les mettre au rebut, conformez-vous à la réglementation en vigueur. Lorsque vous remplacez la pile de sauvegarde ou celle de l'horloge temps réel, veillez à n'utiliser que les modèles cités dans la liste de pièces détachées adéquate. Une batterie ou une pile inappropriée risque de prendre feu ou d'exploser.

Die Bereitschaftsbatterie, die sich unter dem Diskettenlaufwerk befindet, kann geringe Mengen Nickel und Cadmium enthalten. Sie darf nicht zerlegt, wiederaufgeladen, kurzgeschlossen, oder Feuer oder Wasser ausgesetzt werden. Bei der Entsorgung die örtlichen Bestimmungen für Sondermüll beachten. Beim Ersetzen der Bereitschafts- oder Systembatterie nur Batterien des Typs verwenden, der in der Ersatzteilliste aufgeführt ist. Der Einsatz falscher Batterien kann zu Entzündung oder Explosion führen.

סוללות המתנה מסוימות מכילות כמות קטנה של ניקל וקדמיום. אין לפרק סוללת המתנה, לטעון אותה מחדש, להשליך אותה לנאש או למים או לקצר אותה. יש לשלוק את הסוללה בנדרש על ידי התקנות והחוקים המקומיים. יש להשתמש רק בסוללה המופיעה ברשימת החלקים המתאימה. שימוש בסוללה לא מתאימה עלול לגרום להצתה או התפוצצות של הסוללה.

Alcune batterie di riserva contengono una piccola quantità di nichel e cadmio. Non smontarle, ricaricarle, gettarle nel fuoco o nell'acqua né cortocircuitarle. Smaltirle secondo la normativa in vigore (DPR 915/82, successive disposizioni e disposizioni locali). Quando si sostituisce la batteria dell'RTC (real time clock) o la batteria di supporto, utilizzare soltanto i tipi inseriti nell'appropriato Catalogo parti. L'impiego di una batteria non adatta potrebbe determinare l'incendio o l'esplosione della batteria stessa.

予備バッテリーの中には少量のニッケルとカドミウムが含まれているものがあります。したがって、予備バッテリーの分解、再充電、火または水の中への投棄、またはショートさせることは決して行わないでください。バッテリーを廃棄する場合は地方自治体の条例に従ってください。適切なパーツ・リストにあるバッテリーだけを使用してください。誤ったバッテリーを使用すると、バッテリーが発火したり、爆発したりすることがあります。

Algunas baterías de reserva contienen una pequeña cantidad de níquel y cadmio. No las desmonte, ni recargue, ni las eche al fuego o al agua ni las cortocircuite. Deséchelas tal como dispone la normativa local. Utilice sólo baterías que se encuentren en la lista de piezas. La utilización de una batería no apropiada puede provocar la ignición o explosión de la misma.

Safety notice 3**⚠ DANGER**

The battery pack contains small amounts of nickel. Do not disassemble it, throw it into fire or water, or short-circuit it. Dispose of the battery pack as required by local ordinances or regulations. Use only the battery in the appropriate parts listing when replacing the battery pack. Use of an incorrect battery can result in ignition or explosion of the battery.

La batterie contient du nickel. Ne la démontez pas, ne l'exposez ni au feu ni à l'eau. Ne la mettez pas en court-circuit. Pour la mettre au rebut, conformez-vous à la réglementation en vigueur. Lorsque vous remplacez la batterie, veillez à n'utiliser que les modèles cités dans la liste de pièces détachées adéquate. En effet, une batterie inappropriée risque de prendre feu ou d'exploser.

Akkumulační články obsahují malé množství niklu. Nemějte je rozmontovat, nehoďte je do ohně ani do vody, nekrátkujete. Odstraňujte je podle místních předpisů nebo předpisů. Používejte pouze baterie uvedené v seznamu dílů. Použití nesprávných baterií může způsobit vznícení nebo explozi článků.

מארו הסוללה מכיל כמויות קטנות של ניקל וקדמיום. אין לפרק את מארו הסוללה, להשליך אותו לאש או למים או לקצר אותו. יש לשלוק את מארו הסוללה כנדרש על ידי התקנות והחוקים המקומיים. יש להשתמש רק בסוללה המופיעה ברשימת החלקים המתאימה בזמן החלפת מארו הסוללה. שימוש בסוללה לא מתאימה עלול לגרום להצתה או התפוצצות של הסוללה.

La batteria contiene piccole quantità di nichel. Non smontarla, gettarla nel fuoco o nell'acqua né cortocircuitarla. Smaltirla secondo la normativa in vigore (DPR 915/82, successive disposizioni e disposizioni locali). Quando si sostituisce la batteria, utilizzare soltanto i tipi inseriti nell'appropriato Catalogo parti. L'impiego di una batteria non adatta potrebbe determinare l'incendio o l'esplosione della batteria stessa.

バッテリー・パックには少量のニッケルが含まれています。バッテリー・パックを分解したり、火または水の中に投げ込んだり、ショートさせないでください。バッテリー・パックの廃棄にあたっては、地方自治体の条例または規則に従ってください。バッテリー・パックを交換するときは、適切なパーツ・リストにあるバッテリーだけを使用してください。誤ったバッテリーを使用すると、バッテリーが発火したり、爆発したりすることがあります。

Las baterías contienen pequeñas cantidades de níquel. No las desmonte, ni recargue, ni las eche al fuego o al agua ni las cortocircuite. Deséchelas tal como dispone la normativa local. Utilice sólo baterías que se encuentren en la lista de piezas al sustituir la batería. La utilización de una batería no apropiada puede provocar la ignición o explosión de la misma.

Safety notice 4

DANGER

The lithium battery can cause a fire, an explosion, or a severe burn. Do not recharge it, remove its polarized connector, disassemble it, heat it above 100°C (212°F), incinerate it, or expose its cell contents to water. Dispose of the battery as required by local ordinances or regulations. Use only the battery in the appropriate parts listing. Use of an incorrect battery can result in ignition or explosion of the battery.

La pile de sauvegarde contient du lithium. Elle présente des risques d'incendie, d'explosion ou de brûlures graves. Ne la rechargez pas, ne retirez pas son connecteur polarisé et ne la démontez pas. Ne l'exposez pas à une température supérieure à 100°C, ne la faites pas brûler et n'en exposez pas le contenu à l'eau. Mettez la pile au rebut conformément à la réglementation en vigueur. Une pile inappropriée risque de prendre feu ou d'exploser.

Die Systematterie ist eine Lithiumatterie. Sie kann sich entzünden, explodieren oder schwere Verbrennungen hervorrufen. Batterien dieses Typs dürfen nicht aufgeladen, zerlegt, über 100 C erhitzt oder verbrannt werden. Auch darf ihr Inhalt nicht mit Wasser in Verbindung gebracht oder der zur richtigen Polung angebrachte Verbindungsstecker entfernt werden. Bei der Entsorgung die örtlichen Bestimmungen für Sondermüll beachten. Beim Ersetzen der Batterie nur Batterien des Typs verwenden, der in der Ersatzteilliste aufgeführt ist. Der Einsatz falscher Batterien kann zu Entzündung oder Explosion führen.

סוללת הליתיום עלולה לגרום לשריפה, להתפוצצות או למוות קשות. אין לטעון אותה מחדש, לטלוק את המחבר המקוטב שלה, לפרק אותה או לחמם אותה לטמפרטורה העולה על 100 מעלות צלזיוס. אין לשרוף את הסוללה ואין לחשוף את תוכן התא למים. יש לטלוק את הסוללה כנדרש בתקנות ובחוקים המקומיים. יש להשתמש רק בסוללה המומינה ברשימת החלקים המתאימים. שימוש בסוללה אחרת עלול לגרום לשכנת שריפה או התפוצצות.

La batteria di supporto e una batteria al litio e puo incendiarsi, esplodere o procurare gravi ustioni. Evitare di ricaricarla, smontarne il connettore polarizzato, smontarla, riscaldarla ad una temperatura superiore ai 100 gradi centigradi, incendiarla o gettarla in acqua. Smaltirla secondo la normativa in vigore (DPR 915/82, successive disposizioni e disposizioni locali). L'impiego di una batteria non adatta potrebbe determinare l'incendio o l'esplosione della batteria stessa.

リチウム・バッテリーは、火災、爆発、または重症のやけどを引き起こすことがあります。バックアップ・バッテリーの充電、その極性コネクタの取り外し、バッテリー本体の分解、100°C (212°F) 以上への加熱、焼却、電池の中身を水に浸すことはしないでください。バッテリーを廃棄する場合は地方自治体の条例に従ってください。適切なパーツ・リストにあるバッテリーだけを使用してください。誤ったバッテリーを使用すると、バッテリーが発火したり、爆発したりすることがあります。

La batería de repuesto es una batería de litio y puede provocar incendios, explosiones o quemaduras graves. No la recargue, ni quite el conector polarizado, ni la desmonte, ni caliente por encima de los 100°C (212°F), ni la incinere ni exponga el contenido de sus celdas al agua. Deséchela tal como dispone la normativa local.

Safety notice 5

If the LCD breaks and the fluid from inside the LCD gets into your eyes or on your hands, immediately wash the affected areas with water at least for 15 minutes. Seek medical care if any symptoms caused by the fluid are present after washing.

Si le panneau d'affichage à cristaux liquides se brise et que vous recevez dans les yeux ou sur les mains une partie du fluide, rincez-les abondamment pendant au moins quinze minutes. Consultez un médecin si des symptômes persistent après le lavage.

Die Leuchtstoffröhre im LCD-Bildschirm enthält Quecksilber. Bei der Entsorgung die örtlichen Bestimmungen für Sondermüll beachten. Der LCD-Bildschirm besteht aus Glas und kann zerbrechen, wenn er unsachgemäß behandelt wird oder der Computer auf den Boden fällt. Wenn der Bildschirm beschädigt ist und die darin befindliche Flüssigkeit in Kontakt mit Haut und Augen gerät, sollten die betroffenen Stellen mindestens 15 Minuten mit Wasser abgespült und bei Beschwerden anschließend ein Arzt aufgesucht werden.

אם מסך הנביש הנוזלי (LCD) נשבר והנוזל מתוך המסך בא במגע עם עיניים או ידיים, שטפו את האזורים הנוגעים מיד במים במשך 15 דקות לפחות. פנו לקבלת עזרה רפואית אם תסמינים הנובעים מהמגע עם הנוזל נמשכים לאחר השטיפה.

Nel caso che caso l'LCD si dovesse rompere ed il liquido in esso contenuto entrasse in contatto con gli occhi o le mani, lavare immediatamente le parti interessate con acqua corrente per almeno 15 minuti; poi consultare un medico se i sintomi dovessero permanere.

LCD が破損し、LCD 中の液体が目に入ったり、手に触れたりした場合は、液体が触れた部分を少なくとも 15 分間洗い流してください。洗い流した後に、液体によって何らかの症状が現れた場合は、医師の治療を受けてください。

Si la LCD se rompe y el fluido de su interior entra en contacto con sus ojos o sus manos, lave inmediatamente las áreas afectadas con agua durante 15 minutos como mínimo. Obtenga atención medica si se presenta algún sintoma del fluido despues de lavarse.

Safety notice 6

⚠ DANGER

To avoid shock, do not remove the plastic cover that protects the lower part of the inverter card.

Afin d'éviter tout risque de choc électrique, ne retirez pas le cache en plastique protégeant la partie inférieure de la carte d'alimentation.

Aus Sicherheitsgründen die Kunststoffabdeckung, die den unteren Teil der Spannungswandlerplatine umgibt, nicht entfernen.

כדי למנוע התחשמלות, אין להסיר את מכסה הפלסטיק המגן על חלקו התחתון של הכרטיס ההפוך.

Per evitare scosse elettriche, non rimuovere la copertura in plastica che avvolge la parte inferiore della scheda invertitore.

感電を防ぐため、インバーター・カードの下部を保護しているプラスチック・カバーを外さないでください。

Para evitar descargas, no quite la cubierta de plástico que rodea la parte baja de la tarjeta invertida.

Safety notice 7

⚠ DANGER

Though the main batteries have low voltage, a shorted or grounded battery can produce enough current to burn personnel or combustible materials.

Bien que le voltage des batteries principales soit peu élevé, le court-circuit ou la mise à la masse d'une batterie peut produire suffisamment de courant pour brûler des matériaux combustibles ou causer des brûlures corporelles graves.

Obwohl Hauptbatterien eine niedrige Spannung haben, können sie doch bei Kurzschluß oder Erdung genug Strom abgeben, um brennbare Materialien zu entzünden oder Verletzungen bei Personen hervorzurufen.

אף שהסוללות הראשיות הן בעלות מתח נמוך, סוללה מקוצרת או מוארקת עלולה להפיק זרם מספיק לגרימת כוויות או להצתת חומרים דליקים.

Sebbene le batterie di alimentazione siano a basso voltaggio, una batteria in corto circuito o a massa può fornire corrente sufficiente da bruciare materiali combustibili o provocare ustioni ai tecnici di manutenzione.

メイン・バッテリーの電圧は低くても、ショートしたり、接地したバッテリーが、作業者にやけどを負わせたり、可燃物を燃やすだけの電流を発生させる場合があります。

Aunque las baterías principales tienen un voltaje bajo, una batería cortocircuitada o con contacto a tierra puede producir la corriente suficiente como para quemar material combustible o provocar quemaduras en el personal.

Safety notice 8

⚠ DANGER

Before removing any FRU, turn off the computer, unplug all power cords from electrical outlets, remove the battery pack, and then disconnect any interconnecting cables.

Avant de retirer une unité remplaçable en clientèle, mettez le système hors tension, débranchez tous les cordons d'alimentation des socles de prise de courant, retirez la batterie et déconnectez tous les cordons d'interface.

Die Stromzufuhr muß abgeschaltet, alle Stromkabel aus der Steckdose gezogen, der Akku entfernt und alle Verbindungskabel abgenommen sein, bevor eine FRU entfernt wird.

לפני סילוק FRU כלשהו, יש לכבות את המחשב, לנתק את כל כבלי החשמל משקעי החשמל, להוציא את מטריז הסוללה, ואז לנתק כבלי חיבור אחרים אם יש כאלה.

Prima di rimuovere qualsiasi FRU, spegnere il sistema, scollegare dalle prese elettriche tutti i cavi di alimentazione, rimuovere la batteria e poi scollegare i cavi di interconnessione.

FRU を取り外す前に、**ThinkPad** の電源を切って、すべての電源コードをコンセントから外してください。次に、バッテリー・パックを外し、相互接続ケーブルを外してください。

Antes de quitar una FRU, apague el sistema, desenchufe todos los cables de las tomas de corriente eléctrica, quite la batería y, a continuación, desconecte cualquier cable de conexión entre dispositivos.

Laser compliance statement

Some models of Lenovo computer are equipped from the factory with an optical storage device such as a CD-ROM drive or a DVD-ROM drive. Such devices are also sold separately as options. If one of these drives is installed, it is certified in the U.S. to conform to the requirements of the Department of Health and Human Services 21 Code of Federal Regulations (DHHS 21 CFR) Subchapter J for Class 1 laser products. Elsewhere, the drive is certified to conform to the requirements of the International Electrotechnical Commission (IEC) 825 and CENELEC EN 60 825 for Class 1 laser products.

If a CD-ROM drive, a DVD-ROM drive, or another laser device is installed, note the following:

CAUTION

Use of controls or adjustments or performance of procedures other than those specified herein might result in hazardous radiation exposure.

O uso de controles, ajustes ou desempenho de procedimentos diferentes daqueles aqui especificados pode resultar em perigosa exposição à radiação.

凡未在这里指明的任何控制用法、调整、行为，都会导致严重后果。

Pour éviter tout risque d'exposition au rayon laser, respectez les consignes de réglage et d'utilisation des commandes, ainsi que les procédures décrites.

Werden Steuer- und Einstellelemente anders als hier festgesetzt verwendet, kann gefährliche Laserstrahlung auftreten.

Az itt előírt eljárásoktól, beállítástól és vezérlésektől eltérni a lézersugárzás veszélye miatt kockázatos!

L'utilizzo di controlli, regolazioni o l'esecuzione di procedure diverse da quelle specificate possono provocare l'esposizione a.

Использование элементов настройки и выполнение процедур иных, чем указано здесь, может привести к опасному радиационному облучению.

Použitie kontrol, úprav alebo iných vykonaní od iných výrobcov, ako je v tomto špecifikované, mohlo by mať za následok nebezpečenstvo vystavenia sa vyžiarovaniu.

本書で指定された内容以外の、お客様による整備、調整、または手順を行った場合、レーザー光の放射の危険があります。

El uso de controles o ajustes o la ejecución de procedimientos distintos de los aquí especificados puede provocar la exposición a radiaciones peligrosas.

Opening the CD-ROM drive, the DVD-ROM drive, or any other optical storage device could result in exposure to hazardous laser radiation. There are no serviceable parts inside those drives. **Do not open.**

A CD-ROM drive, a DVD-ROM drive, or any other storage device installed may contain an embedded Class 3A or Class 3B laser diode. Note the following:

⚠ DANGER

Emits visible and invisible laser radiation when open. Do not stare into the beam, do not view directly with optical instruments, and avoid direct exposure to the beam.

Radiação por raio laser ao abrir. Não olhe fixo no feixe de luz, não olhe diretamente por meio de instrumentos óticos e evite exposição direta com o feixe de luz.

开启时会有激光发射时，请勿盯视激光光束，请勿直接查看视觉仪器，并且避免直接接触在激光光束之中。

Rayonnement laser si carter ouvert. Évitez de fixer le faisceau, de le regarder directement avec des instruments optiques, ou de vous exposer au rayon.

Laserstrahlung bei geöffnetem Gerät. Nicht direkt oder über optische Instrumente in den Laserstrahl sehen und den Strahlungsbereich meiden.

Kinyitáskor lézersugár ! Ne nézzen bele se szabad szemmel, se optikai eszközökkel. Kerülje a sugárnyalábbal való érintkezést!

Aprendo l'unità vengono emesse radiazioni laser. Non fissare il fascio, non guardarlo direttamente con strumenti ottici e evitare l'esposizione diretta al fascio.

Открывая, берегитесь лазерного излучения.

Не смотрите на луч, не разглядывайте его с помощью оптических инструментов, а также избегайте прямого воздействия лазерного луча.

Keď je laserová jednotka otvorená. Vyhňte sa priamemu pohľadu a neľadte priamo s optickými nástrojmi do lúča a vyhňte sa priamemu vystaveniu lúčov.

開けるとレーザー光が放射されます。光線を見つめたり、光学機械を使って直接見たりしないでください。

Radiación láser al abrir. No mire fijamente ni examine con instrumental óptico el haz de luz. Evite la exposición directa al haz.

Important service information

This chapter presents the following important service information:

- “Strategy for replacing FRUs” on page 16
 - “Strategy for replacing a hard disk drive” on page 17
 - “Important notice for replacing a system board” on page 17
- “Important information about replacing RoHS compliant FRUs” on page 18

Important:

BIOS and device driver fixes are customer-installable. The BIOS and device drivers are posted on the customer support site:

<http://support.lenovo.com>.

Strategy for replacing FRUs

Before replacing parts:

Make sure that all software fixes, drivers, and BIOS downloads are installed before replacing any FRUs listed in this manual.

After a system board is replaced, ensure that the latest BIOS is loaded to the system board before completing the service action.

To download software fixes, drivers, and BIOS, follow the steps below:

1. Go to <http://support.lenovo.com>.
2. Enter the serial number or select a product or use Lenovo smart downloading.
3. Select the BIOS/Driver/Applications and download.
4. Follow the directions on the screen and install the necessary software.

Use the following strategy to prevent unnecessary expense for replacing and servicing FRUs:

- If you are instructed to replace an FRU, but the replacement does not solve the problem, reinstall the original FRU before you continue.
- Some computers have both a processor board and a system board. If you are instructed to replace either of them, and replacing one of them does not solve the problem, reinstall that board, and then replace the other one.
- If an adapter or a device consists of more than one FRU, any of the FRUs may be the cause of the error. Before replacing the adapter or device, remove the FRUs one by one to see if the symptoms change. Replace only the FRU that changed the symptoms.

Attention: The setup configuration on the computer you are servicing may have been customized. Running Automatic Configuration may alter the settings. Note the current configuration settings (using the View Configuration option); then, when service has been completed, verify that those settings remain in effect.

Strategy for replacing a hard disk drive

Always try to run a low-level format before replacing a hard disk drive. This will cause all customer data on the hard disk to be lost. Make sure that the customer has a current backup of the data before performing this action.

Attention: The drive startup sequence in the computer you are servicing may have been changed. Be extremely careful during write operations such as copying, saving, or formatting. If you select an incorrect drive, data or programs can be overwritten.

Important notice for replacing a system board

Some components mounted on a system board are very sensitive. Improper handling can cause damage to those components, and may cause a system malfunction.

Attention: When handling a system board:

- Do not drop the system board or apply any excessive force to it.
- Avoid rough handling of any kind.
- Avoid bending the system board and hard pushing to prevent cracking at each BGA (Ball Grid Array) chipset.

Important information about replacing RoHS compliant FRUs

RoHS, The Restriction of Hazardous Substances in Electrical and Electronic Equipment Directive (2002/95/EC) is a European Union legal requirement affecting the global electronics industry. RoHS requirements must be implemented on Lenovo products placed on the market after June 2006. Products on the market before June 2006 are not required to have RoHS compliant parts. If the original FRU parts are non-compliant, replacement parts can also be non-compliant. In all cases if the original FRU parts are RoHS compliant, the replacement part must also be RoHS compliant.

Note: RoHS and non-RoHS FRU part numbers with the same fit and function are identified with unique FRU part numbers.

Lenovo plans to transit to RoHS compliance well before the implementation date and expects its suppliers to be ready to support Lenovo's requirements and schedule in the EU. Products sold in 2005 and 2006 will contain some RoHS compliant FRUs. The following statement pertains to these products and any product Lenovo produces containing RoHS compliant FRUs.

RoHS compliant FRUs have unique FRU part numbers. Before or after the RoHS implementation date, failed RoHS compliant parts must always be replaced with RoHS compliant ones, so only the FRUs identified as compliant in the system HMM or direct substitutions for those FRUs may be used.

Products marketed before June 2006		Products marketed after June 2006	
Current or original part	Replacement FRU	Current or original part	Replacement FRU
Non-RoHS	Can be Non-RoHS	Must be RoHS	Must be RoHS
Non-RoHS	Can be RoHS		
Non-RoHS	Can sub to RoHS		
RoHS	Must be RoHS		

Note: A direct substitution is a part with a different FRU part number that is automatically shipped by the distribution center at the time of the order.

General checkout

This chapter presents the following information:

- “What to do first” on page 20
- “Power system checkout” on page 21

Before you go to the checkout, make sure to read the following important notes:

Important notes:

- **Only certified trained personnel can service the computer.**
- **Before replacing any FRU, read the entire page on removing and replacing FRUs.**
- **Carefully remove screws for reuse when replacing FRUs.**
- **Be extremely careful during such write operations as copying, saving, or formatting.** Drives in the computer that you are servicing sequence might have been altered. If you select an incorrect drive, data or programs might be overwritten.
- **Replace an FRU only with another FRU of the correct model.** When you replace an FRU, make sure that the machine model and the FRU part number are correct by referring to the FRU parts list.
- **An FRU should not be replaced just because of a single, unreproducible failure.** Single failures can occur for a variety of reasons that have nothing to do with a hardware defect, such as cosmic radiation, electrostatic discharge, or software errors. Consider replacing an FRU only when a problem recurs. If you suspect that an FRU is defective, clear the error logs and run the test again. If the error does not recur, do not replace the FRU.
- **Be careful not to replace a nondefective FRU.**

What to do first

When you do return an FRU, you must include the following information in the parts exchange form or parts return form that you attach to it:

1. Name and phone number of servicer
2. Date of service
3. Date on which the machine failed
4. Date of purchase
5. Procedure index and page number in which the failing FRU was detected
6. Failing FRU name and part number
7. Machine type, model number, and serial number
8. Customer's name and address

Note for warranty: During the warranty period, the customer may be responsible for repair costs if the computer damage was caused by misuse, accident, modification, unsuitable physical or operating environment, or improper maintenance by the customer.

The following is a list of some common items that are not covered under warranty and some symptoms that might indicate that the system was subjected to stress beyond normal use.

Before checking problems with the computer, determine whether the damage is covered under the warranty by referring to the following list:

The following are not covered under warranty:

- LCD panel cracked from the application of excessive force or from being dropped
- Scratched (cosmetic) parts
- Distortion, deformation, or discoloration of the cosmetic parts
- Plastic parts, latches, pins, or connectors that have been cracked or broken by excessive force
- Damage caused by liquid spilled into the system
- Damage caused by the improper insertion of a PC Card or the installation of an incompatible card
- Improper disk insertion or use of an optical drive
- Diskette drive damage caused by pressure on the diskette drive cover, foreign material in the drive, or the insertion of a diskette with multiple labels
- Damaged or bent diskette eject button
- Fuses blown by attachment of a nonsupported device
- Forgotten computer password (making the computer unusable)
- Sticky keys caused by spilling a liquid onto the keyboard
- Use of an incorrect AC adapter on laptop products

The following symptoms might indicate damage caused by nonwarranted activities:

- Missing parts might be a symptom of unauthorized service or modification.
- If the spindle of a hard disk drive becomes noisy, it may have been subjected to excessive force, or dropped.

Power system checkout

To verify a symptom, follow the steps below:

1. Turn off the computer.
2. Connect the AC adapter.
3. Make sure that power is supplied when you turn on the computer.
4. Turn off the computer.
5. Disconnect the AC adapter.
6. Make sure that the battery pack supplies power when you turn on the computer.

If you suspect a power problem, see the appropriate power supply checkout:

- “Checking the AC adapter” on page 21
- “Checking operational charging” on page 21

Checking the AC adapter

You are here because the computer fails only when the AC adapter is used.

- If the power-on indicator does not turn on, check the power cord of the AC adapter for correct continuity and installation.
- If the computer does not charge during operation, go to “Checking operational charging”.

To check the AC adapter, follow the steps below:

1. Unplug the AC adapter cable from the computer.
2. Measure the output voltage at the plug of the AC adapter cable. See the following figure:



Pin	Voltage (V DC)
1	+20
2	0

Note: Output voltage for the AC adapter pin No. 2 may differ from the one you are servicing.

3. If the voltage is not correct, replace the AC adapter.
4. If the voltage is acceptable, do the following:
 - Replace the system board.
 - If the problem persists, go to “Lenovo Yoga 2 Pro (13”)” on page 27.

Note: Noise from the AC adapter does not always indicate a defect.

Checking operational charging

To check whether the battery charges properly during operation, use a discharged battery pack or a battery pack that has less than 50% of the total power remaining when installed in the computer.

Perform operational charging. If the battery status indicator or icon is not lit, remove the battery pack and let it return to room temperature. Reinstall the battery pack. If the charge indicator or icon is still off, replace the battery pack.

If the charge indicator is still not lit, replace the system board.

Related service information

This chapter presents the following information:

- “Restoring the factory contents by using OneKey Recovery” on page 23
- “Passwords” on page 24
- “Power management” on page 25

Restoring the factory contents by using OneKey Recovery

Restore of factory default

The Lenovo Yoga 2 Pro (13") computer comes with pre-installed OneKey Recovery System. In order to save application files and the initial backed up files of the system, the hard disk in a Lenovo computer includes a hidden partition when it is shipped. If you need to restore the system to the point of your first boot up, just enter Lenovo OneKey Recovery System and run **System Recovery**. For details of OneKey Recovery System, see *the User Guide for Lenovo OneKey Recovery system*.

Note: This will delete all the new data on the system partition (C drive), which is not recoverable. Make sure to back up your critical data before you perform this action.

Passwords

As many as three passwords may be needed for any Lenovo computer: the power-on password (POP), the hard disk password (HDP), and the supervisor password.

If any of these passwords has been set, a prompt for it appears on the screen whenever the computer is turned on. The computer does not start until the password is entered.

Power-on password

A power-on password (POP) protects the system from being powered on by an unauthorized person. The password must be entered before an operating system can be booted.

Hard-disk password

There are two hard-disk passwords (HDPs):

- + User HDP - for the user

- + Master HDP - for the system administrator, who can use it to get access to the hard disk drive even if the user has changed the user HDP

Attention: If the user HDP has been forgotten, check whether a master HDP has been set. If it has, it can be used for access to the hard disk drive. If no master HDP is available, neither Lenovo nor Lenovo authorized service technicians provide any services to reset either the user or the master HDP, or to recover data from the hard disk drive. The hard disk drive can be replaced for a scheduled fee.

Supervisor password

A supervisor password protects the system information stored in the BIOS. The user must enter the supervisor password to get access to the BIOS and change the system configuration.

Attention: If you forget the password, there is no service procedure to reset the password. The system board must be replaced for a scheduled fee.

Power management

Note: Power management modes are not supported for an APM operating system.

To reduce power consumption, the computer has two power management modes: screen blank and sleep (standby).

Screen blank state

If the time set on the “Turn off monitor” timer in the operating system expires, the LCD backlight turns off. You can also turn off the LCD backlight by pressing .



To end screen blank state and resume normal operation, press .

Putting the computer to sleep or shutting it down

When you have finished working with your computer, you can put it to sleep or shut it down.

Putting your computer to sleep

If you will be away from your computer for only a short time, put the computer to sleep. When the computer is in sleep mode, you can quickly wake it to resume use, bypassing the startup process. To put the computer to sleep:

- Close the display panel.
- Press the Power button.
- Move your cursor to the lower-right corner of the screen to open the charms bar, then select **Settings**  → **Power**  → **Sleep**.
- Right-click the Windows icon  on the desktop lower-left corner. Then select **Sleep** from the **Shut down** menu options.

Attention: Wait until the power indicator light starts blinking (indicating that the computer is in sleep mode) before you move your computer. Moving your computer while the hard disk is spinning can damage the hard disk, causing loss of data.

To wake the computer, do one of the following:

- Press any key on the keyboard.
- Press the Power button.

Shutting down the computer

If you are not going to use your computer for a long time, shut it down.

To shut down your computer:

- Open the charms, then select **Settings**  → **Power**  → **Shut down**.
- Right-click the Windows icon  on the desktop lower-left corner. Then select **Shut down** from the **Shut down** menu options.

Lenovo Yoga 2 Pro (13")

This chapter presents the following product-specific service references and product-specific parts information:

- “Specifications” on page 27
- “Status indicators” on page 29
- “Fn key combinations” on page 30
- “FRU replacement notices” on page 31
- “Removing and replacing an FRU” on page 32
- “Locations” on page 58
- “Parts list” on page 60

Specifications

The following table lists the specifications of the Lenovo Yoga 2 Pro (13"):

Table 1. Specifications

Feature	Description
Processor	View the system properties of your computer. You can do this as follows: Open the Control Panel , and then select System .
Bus architecture	<ul style="list-style-type: none"> • PCIe 2.0 • DDR3L 1666MHz • HDMI 1.4 • EDP 5.4G/2.7G • SATA 3.0 • LPC 1.1 • USB 2.0 • USB 3.0 • SMBus • HDA • SPI • I2C
Graphic Chipset	<ul style="list-style-type: none"> • Intel HSW GT2
Display	<ul style="list-style-type: none"> • 13.3 inch, QHD+-3200 x 1800/IPS (wide viewing angle), 350 nit • 13.3 inch, FullHD-1920 x 1080/IPS (wide viewing angle), 330 nit (typ, w/o touch panel); 290 nit (typ w/ touch panel)
Standard memory	<ul style="list-style-type: none"> • DDR3L-1600MHz (max 8 GB)
CMOS	<ul style="list-style-type: none"> • 256 bytes
SSD	<ul style="list-style-type: none"> • 4 GB, 128 GB, 256 GB or 512 GB
Optical drive	<ul style="list-style-type: none"> • 2.5 inch External 9.5 mm (on select models)
I/O port	<ul style="list-style-type: none"> • Combo audio jack × 1 • HDMI port × 1 • USB 2.0 port × 1, USB 3.0 port × 1 • 2 in 1 slot × 1

Table 1. Specifications (continued)

Feature	Description
Audio	<ul style="list-style-type: none">• 1/8" Combo audio jack• Integrated Speakers Stereo × 2• Built-in microphone × 2
PCI Express Mini Card slot	<ul style="list-style-type: none">• 1 slot
Bluetooth wireless	<ul style="list-style-type: none">• Combined in combo card
Keyboard	<ul style="list-style-type: none">• 6-Row, Lenovo Keyboard
Touch pad	<ul style="list-style-type: none">• Multi-touch type
Integrated camera	<ul style="list-style-type: none">• 1.0 Mega or 720P HD
Battery	<ul style="list-style-type: none">• 4 cells, 54 Wh
AC adapter	<ul style="list-style-type: none">• 20 V, 65 W
Pre-installed operating system	<ul style="list-style-type: none">• Windows 8.1

Status indicators

The system status indicators below show the computer status:















Table 2. Status indicators

Indicator	Indicator status	Meaning
Battery status indicator	On (solid white)	The battery has more than 20% charge.
	Solid amber	The battery has between 5% and 20% charge.
	Fast blinking amber	The battery has less than 5% charge.
	Slow blinking amber	The battery is being charged. When battery charge reaches 20%, the blinking color changes to white.
	Slow blinking white	The battery has between 20% and 80% charge and is still charging. When the battery reaches 80% charge the light will stop blinking, but charging will continue until the battery is fully charged.
Power status indicator 	On (solid white)	The computer is powered on.
	Blinking	The computer is in sleep mode.
	Off	The computer is powered off.

Fn key combinations

The following table describes the functions of Fn key combinations.

Table 3. Function key combinations

 : F1	Mutes/unmutes the sound.
 : F2	Decreases the volume level.
 : F3	Increases the volume level.
 : F4	Closes the currently active window.
 : F5	Refreshes the desktop or the currently active window.
 : F6	Enables/disables the touchpad.
 : F7	Enables/disables Airplane mode.
 : F8	Displays all currently active apps.
 : F9	Turns on/off the backlight of the LCD screen.
 : F10	Toggles the display between the computer and an external device.
 : F11	Decreases display brightness.
 : F12	Increases display brightness.

FRU replacement notices

This section presents notices related to removing and replacing parts. Read this section carefully before replacing any FRU.

Screw notices

Loose screws can cause a reliability problem. In the Lenovo computer, this problem is addressed with special nylon-coated screws that have the following characteristics:

- They maintain tight connections.
- They do not easily come loose, even with shock or vibration.
- They are harder to tighten.

Do the following when you service this machine:

- Keep the screw kit in your tool bag.
- Carefully remove screws for reuse when replacing FRUs.
- Use a torque screwdriver if you have one.

Tighten screws as follows:

- **Plastic to plastic**

Turn an additional 90° after the screw head touches the surface of the plastic part:

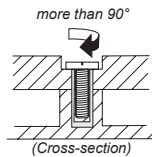

- **Logic card to plastic**

Turn an additional 180° after the screw head touches the surface of the logic card:

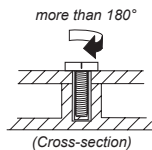

- **Torque driver**

If you have a torque screwdriver, refer to the "Torque" column for each step.

- Make sure that you use the correct screws. If you have a torque screwdriver, tighten all screws firmly to the torque shown in the table. **Carefully remove screws for reuse when replacing FRUs. Make sure that all screws are tightened firmly.**
- Ensure torque screwdrivers are calibrated correctly following country specifications.

Removing and replacing an FRU

This section presents exploded figures with the instructions to indicate how to remove and replace the FRU. Make sure to observe the following general rules:

1. Do not attempt to service any computer unless you have been trained and certified. An untrained person runs the risk of damaging parts.
2. Before replacing any FRU, review "FRU replacement notices" on page 31.
3. Begin by removing any FRUs that have to be removed before the failing FRU. Any of such FRUs are listed at the top of the page. Remove them in the order in which they are listed.
4. Follow the correct sequence in the steps to remove the FRU, as given in the figures by the numbers in square callouts.
5. When turning a screw to replace an FRU, turn it in the direction as given by the arrow in the figure.
6. When removing the FRU, move it in the direction as given by the arrow in the figure.
7. To put the new FRU in place, reverse the removal procedures and follow any of the notes that pertain to replacement. For information about connecting and arranging internal cables, see "Locations" on page 58.
8. When replacing an FRU, use the correct screw as shown in the procedures.

DANGER

Before removing any FRU, turn off the computer, unplug all power cords from electrical outlets, remove the battery pack, and then disconnect any of the interconnecting cables.

Attention: After replacing an FRU, do not turn on the computer until you have made sure that all screws, springs, and other small parts are in place and none are loose inside the computer. Verify this by shaking the computer gently and listening for rattling sounds. Metallic parts or metal flakes can cause electrical short circuits.

Attention: The system board is sensitive to, and can be damaged by, electrostatic discharge. Before touching it, establish personal grounding by touching a ground point with one hand or using an electrostatic discharge (ESD) strap (P/N 6405959) to remove potential shock reasons.

1010 Base cover

Figure 1. Removal steps of base cover

Remove the screws **1**. Then remove the base cover **2**.

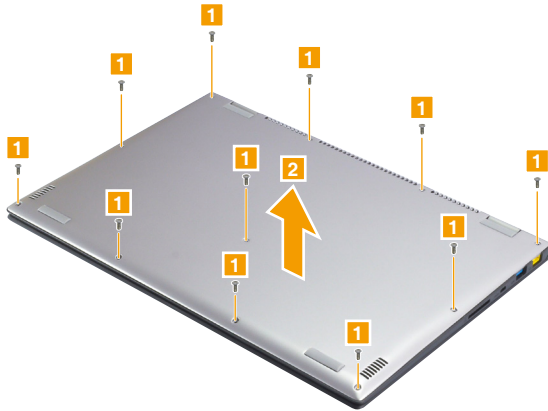

Step	Screw (quantity)	Color	Torque
1	M2 × 5 mm, flat-head, nylok-coated (11) Lower to Upper	Silver	1.85+/-0.15 kg*cm

Note: Applying labels to the base cover

The new base cover FRU is shipped with a kit containing labels of several kinds. When you replace the base cover, you need to apply the following labels:

The following labels need to be peeled off from the old base cover and put on the new base cover.

- a** win8 OS label
- b** Rating label(ww or China)
- c** Rating label print
- d** KCC labe
- e** Indonesia D side label
- f** BRAZIL BT WL label
- g** BT WL label FOR US/CA/TW/BRAZIL/INDONESIA/ISRAEL label
- h** SIRIM BT label
- i** SIRIM WL label
- j** SN label

For some models, you also need to apply one or two FCC labels. Check the old base cover; if it has one or two FCC labels, find duplicates of them in the label kit and apply them to the new base cover.

For the location of each label, refer to the following figure:

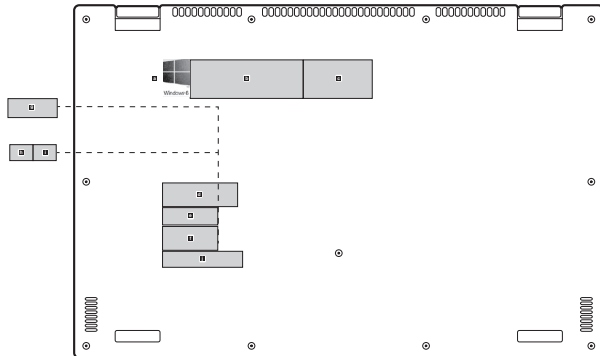

1020 Battery pack

For access, remove this FRU:

- "1010 Base cover" on page 33

⚠ DANGER

Only use the battery specified in the parts list for your computer. Any other battery could ignite or explode.

Figure 2. Removal steps of battery pack

Unplug the battery connector **1** and remove the screws **2**. Then remove the battery pack **3**.

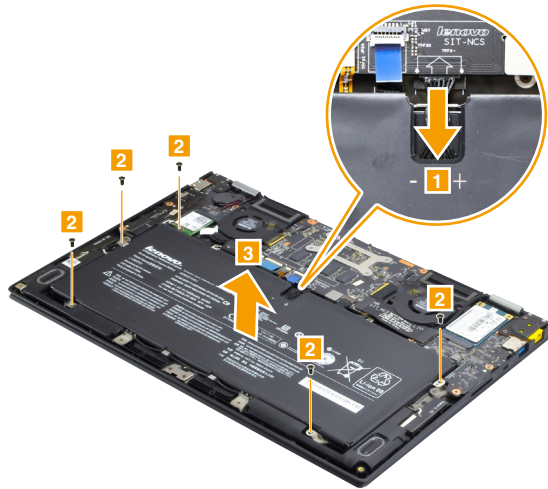

Step	Screw (quantity)	Color	Torque
2	M2 × 3.5 mm, flat-head, nylok-coated (5) Bty to Upper	Black	1.85+/-0.15 kgf*cm

When installing: Make sure that the battery connector is attached firmly.

1030 LCD unit

For access, remove these FRUs in order:

- “1010 Base cover” on page 33
- “1020 Battery pack” on page 35

Figure 3. Removal steps of LCD unit

Remove the SSD cable in the direction shown by arrows **1**.

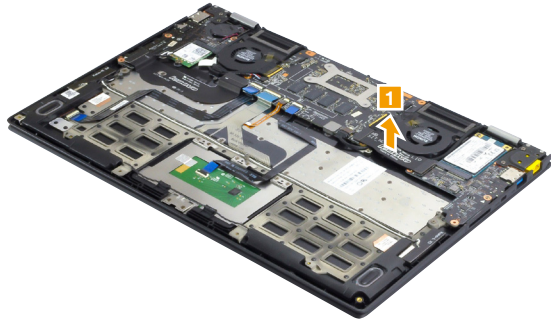

Unplug touch cable connector and LCD cable in the direction shown by arrows **2**. Remove the screws **3**.

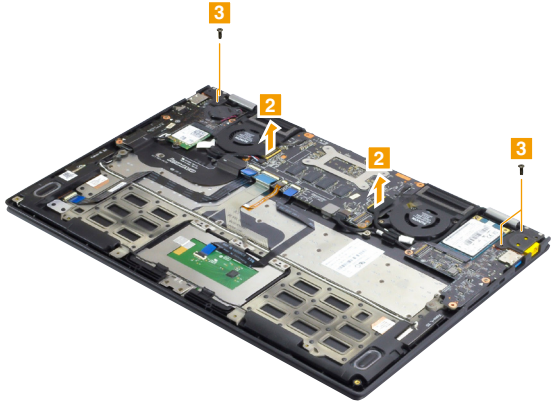

Step	Screw (quantity)	Color	Torque
3	M2 × 4.5 mm, flat-head, nylok-coated (4) Hinge to Upper	Black	1.85+/-0.15 kg*cm

Figure 3. Removal steps of LCD unit (continued)

Open the hinges **4**, then remove the upper case from the LCD unit **5**.

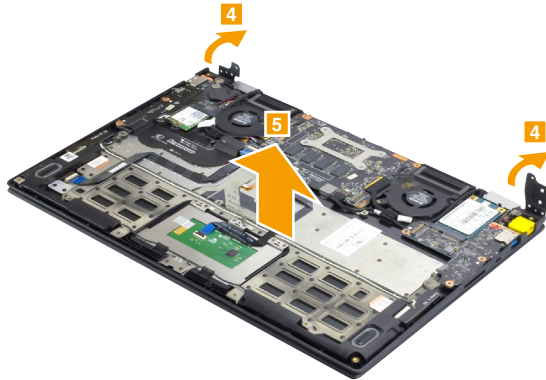

1040 System board

Important notices for handling the system board:

When handling the system board, bear the following in mind.

- Be careful not to drop the system board on a bench top that has a hard surface, such as metal, wood, or composite.
- Avoid rough handling of any kind.
- During the whole process, make sure not to drop or stack the system board.
- If you put a system board down, make sure to put it only on a padded surface, such as an ESD mat or conductive corrugated material.

For access, remove these FRUs in order:

- “1010 Base cover” on page 33
- “1020 Battery pack” on page 35
- “1030 LCD unit” on page 36

Figure 4. Removal steps of system board

Detach the connectors in the direction shown by arrows **1**, **2** and **3**. Remove the FPC in the direction shown by arrow **4**. Then remove the screws **5**.

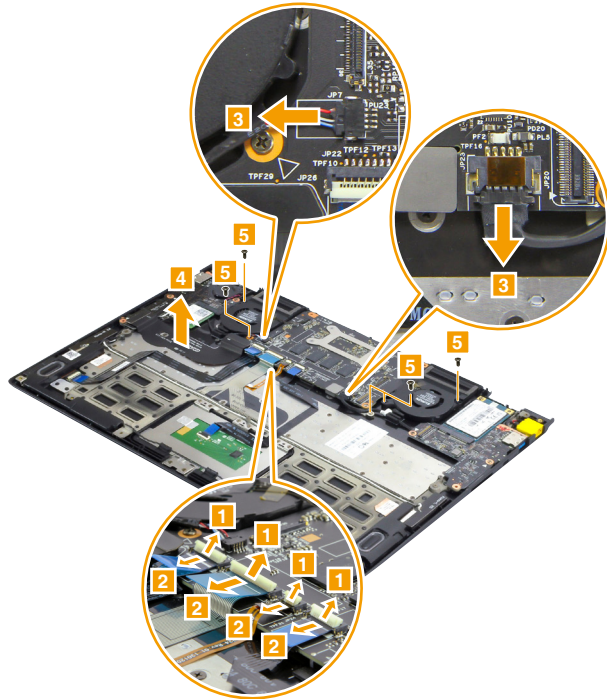

Step	Screw (quantity)	Color	Torque
5	M2 × 3.5 mm, flat-head, nylok-coated (5) MB to Upper	Black	1.85+/-0.15 kgf*cm

Figure 4. Removal steps of system board (continued)

Remove the system board **6**.

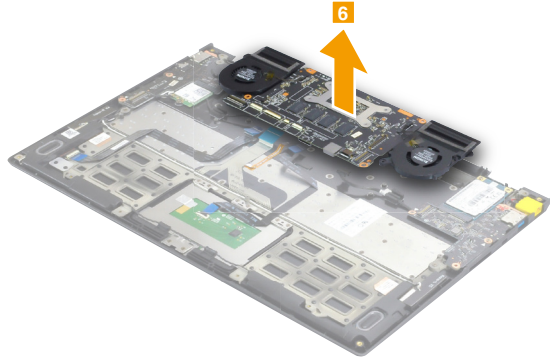

1050 Fan assembly and heat sink assembly

For access, remove these FRUs in order:

- “1010 Base cover” on page 33
- “1020 Battery pack” on page 35
- “1030 LCD unit” on page 36
- “1040 System board” on page 38

Figure 5. Removal steps of fan assembly and heat sink assembly

Disconnect the fan connectors in the direction shown by arrows .

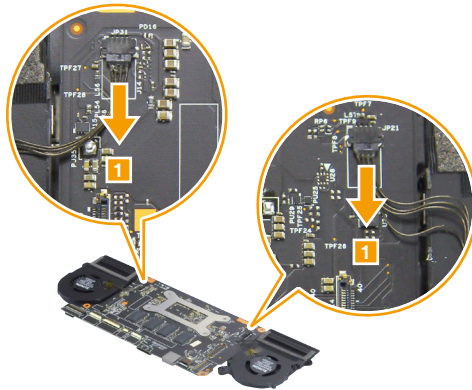

When installing: Make sure that the connectors are attached firmly.

Figure 5. Removal steps of hard disk drive and solid state disk (continued)

Turn over the system board, then loosen the screws **2**.

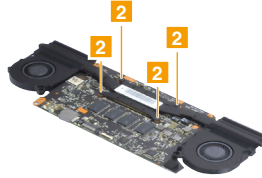

Lift the fan assembly and heat sink assembly in the direction shown by arrow **3**. Be careful not to damage the connector.

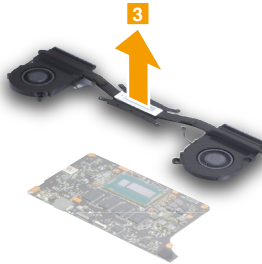

Attention: Do not handle the heat sink assembly roughly. Improper handling can cause distortion or deformation and imperfect contact with components.

1060 PCI Express Mini Card for wireless LAN

For access, remove these FRUs in order:

- “1010 Base cover” on page 33
- “1020 Battery pack” on page 35
- “1030 LCD unit” on page 36
- “1040 System board” on page 38

Figure 6. Removal steps of PCI Express Mini Card for wireless LAN

Disconnect the two wireless LAN cables (black, white) ■, and then remove the screw ■. Remove the card in the direction shown by arrow ■.

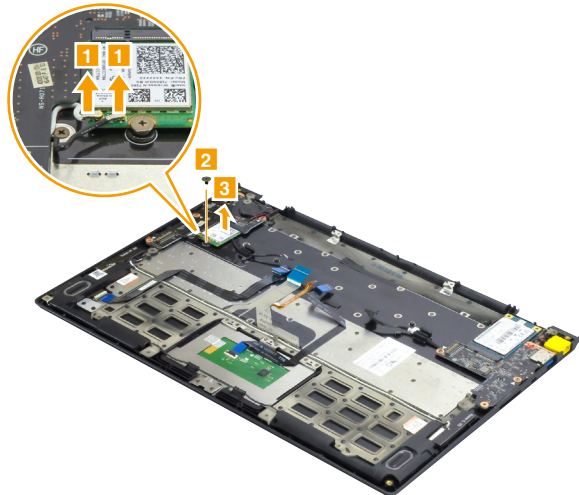

In step ■, unplug the jacks by using the removal tool antenna RF connector (P/N: 08K7159), or pick up the connectors with your fingers and gently unplug them in the direction shown by the arrows.

Notes: The wireless LAN card has 2 cables in step ■.

The wireless LAN card in some models might have 3 cables in step ■.

Step	Screw (quantity)	Color	Torque
2	M2 × 2.5 mm, flat-head, nylok-coated (1) WLAN to Upper	Black	1.85+/-0.15 kgf*cm

When installing:



When installing the wireless LAN card, plug the black cable into the jack labeled **MAIN** and the white cable into the jack labeled **AUX**.

1070 Solid state disk

For access, remove these FRUs in order:

- “1010 Base cover” on page 33
- “1020 Battery pack” on page 35
- “1030 LCD unit” on page 36
- “1040 System board” on page 38

Figure 7. Removal steps of solid state disk

Remove the screw , then remove the solid state disk in the direction shown by arrow .

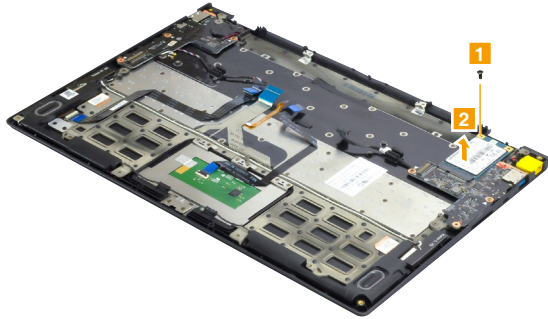

Step	Screw (quantity)	Color	Torque
	M2 × 3.5 mm, flat-head, nylok-coated (1) SSD to Upper	Black	1.85+/-0.15 kgf*cm

1080 Audio board and SSD board

For access, remove these FRUs in order:

- “1010 Base cover” on page 33
- “1020 Battery pack” on page 35
- “1030 LCD unit” on page 36
- “1040 System board” on page 38
- “1060 PCI Express Mini Card for wireless LAN” on page 43
- “1070 Solid state disk” on page 44

Figure 8. Removal steps of audio board and SSD board

Remove the screws **■**, then remove the audio board and the SSD board in the direction shown by arrows **2**.

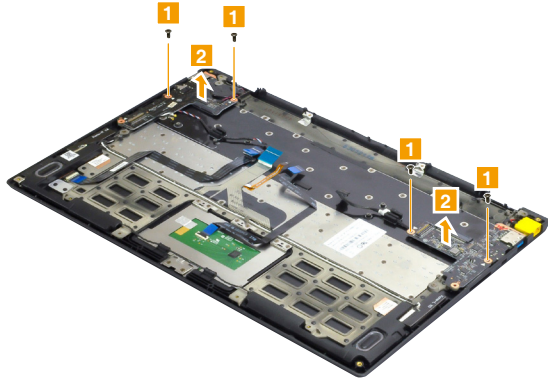

Step	Screw (quantity)	Color	Torque
■	M2 × 3.5 mm, flat-head, nylok-coated (4) Daughter board to Upper	Black	1.85+/-0.15 kgf*cm

1090 Keyboard bezel

For access, remove these FRUs in order:

- “1010 Base cover” on page 33
- “1020 Battery pack” on page 35
- “1030 LCD unit” on page 36
- “1040 System board” on page 38
- “1060 PCI Express Mini Card for wireless LAN” on page 43
- “1070 Solid state disk” on page 44
- “1080 Audio board and SSD board” on page 45

Figure 9. Removal steps of keyboard bezel

Unplug the connectors in the directions shown by arrows **1** and **2**. Remove the FFC and DC-in cables in the direction shown by arrows **3**.

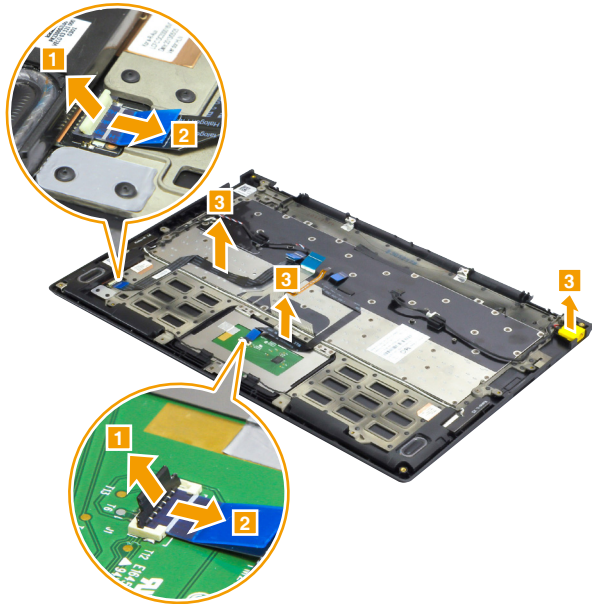
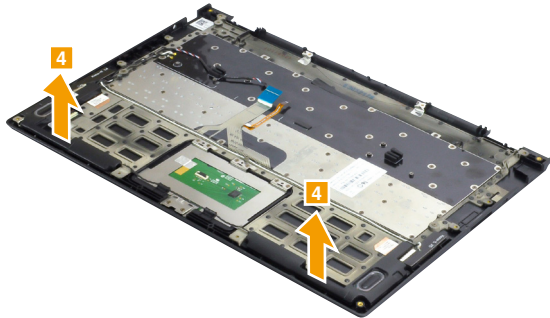
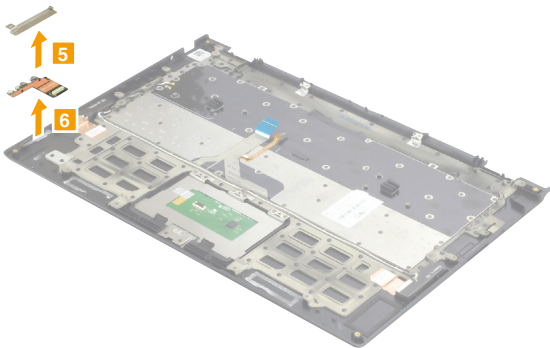

Figure 9. Removal steps of keyboard bezel (continued)

Remove the speakers in the direction shown by arrows **4**.



Remove the power board and the power board bracket in the direction shown by arrows **5** and **6**.



1100 Keyboard

For access, remove these FRUs in order:

- “1010 Base cover” on page 33
- “1020 Battery pack” on page 35
- “1030 LCD unit” on page 36
- “1040 System board” on page 38
- “1060 PCI Express Mini Card for wireless LAN” on page 43
- “1070 Solid state disk” on page 44
- “1080 Audio board and SSD board” on page 45
- “1090 Keyboard bezel” on page 46

Figure 10. Removal steps of keyboard

Remove the screws .

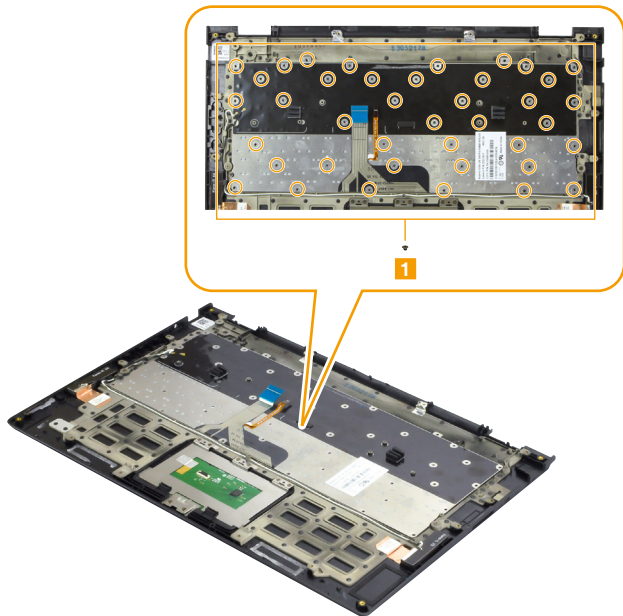

Step	Screw (quantity)	Color	Torque
3	M2 × 1.7 mm, flat-head, nylok-coated (40) Keyboard to Upper	Black	1.85+/-0.15 kgf*cm

Figure 10. Removal steps of keyboard (continued)

Remove the keyboard in the direction shown by arrow **2**.

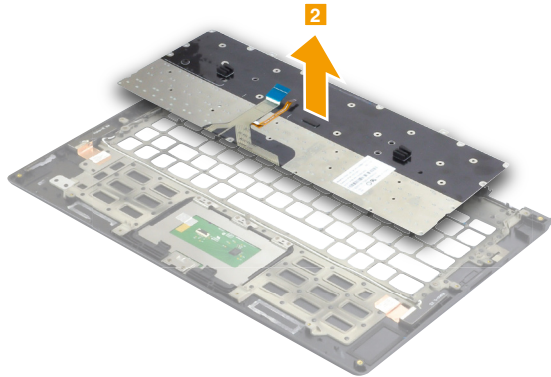

1110 LCD front cover

For access, remove these FRUs in order:

- “1010 Base cover” on page 33
- “1020 Battery pack” on page 35
- “1030 LCD unit” on page 36

Figure 11. Removal steps of LCD front cover

Remove LCD bezel screw pad **1** and the screws **2**.



Step	Screw (quantity)	Color	Torque
2	M2 × 4.5 mm, flat-head, nylok-coated (2) Hinge cover to LCD cover	Black	1.85+/-0.15 kg*cm

Figure 11. Removal steps of LCD front cover (continued)

Remove the hinge cover and strip cover in the direction shown by arrows **3**.

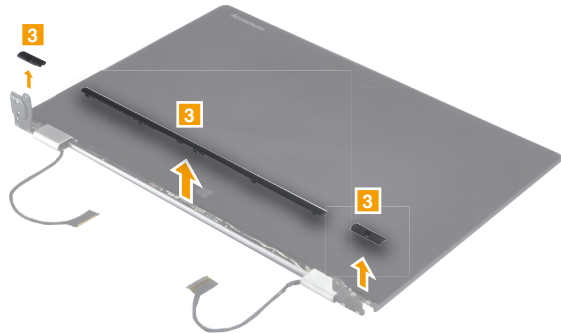

1120 MIC board, LCD cover, and hinges

For access, remove these FRUs in order:

- “1010 Base cover” on page 33
- “1020 Battery pack” on page 35
- “1030 LCD unit” on page 36
- “1110 LCD front cover” on page 50

Figure 12. Removal steps of MIC board, LCD cover, and hinges

Disconnect the MIC board connector **1** and remove the screw **2**. Then remove the MIC board in the direction shown by arrow **3**.



Step	Screw (quantity)	Color	Torque
2	M2 × 2.5 mm, flat-head, nylok-coated (1) MIC board to LCD cover	Black	1.85+/-0.15 kg*cm

Figure 12. Removal steps of MIC board, LCD cover, and hinges (continued)

Adjust the hinges in the direction shown by arrows **4**. Then remove the hinge rubbers **5** and pull out the cables.



Remove the screws **6** and then remove the LCD module in the direction shown by arrow **7**.

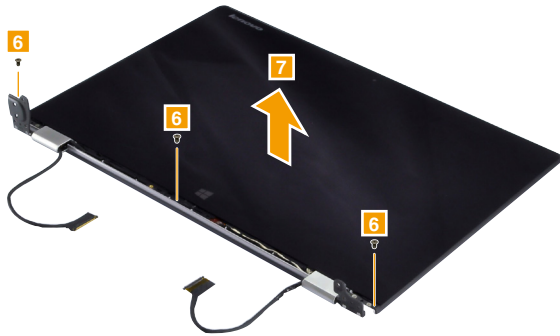

Step	Screw (quantity)	Color	Torque
6	M2 × 3 mm, flat-head, nylok-coated (3) LCD module to LCD cover	Black	1.85±0.15 kg*cm

Figure 12. Removal steps of MIC board, LCD cover, and hinges (continued)

Remove the screws **8**, then remove the hinges **9**.



Step	Screw (quantity)	Color	Torque
8	M2 × 2 mm, flat-head, nylok-coated (4) Hinge to LCD cover	Black	1.85+/-0.15 kgf*cm

1130 LCD module

For access, remove these FRUs in order:

- “1010 Base cover” on page 33
- “1020 Battery pack” on page 35
- “1030 LCD unit” on page 36
- “1110 LCD front cover” on page 50
- “1120 MIC board, LCD cover, and hinges” on page 52

Figure 13. Removal steps of LCD module

Detach the connector in the directions shown by arrows **1** and **2**. Then remove the LCD cable.



Figure 13. Removal steps of LCD module (continued)

Remove the screw **3**. Lift the camera and the camera bracket slightly **4**. Unplug the integrated camera connector in the direction shown by arrow **5**. Remove the integrated camera bracket and integrated camera from the LCD module.



Step	Screw (quantity)	Color	Torque
3	M2 × 2.5 mm, flat-head, nylok-coated (1) Camera to LCD cover	Black	1.85+/-0.15 kg*cm

Figure 13. Removal steps of LCD module (continued)

Unplug the connectors in the directions shown by arrows **6**, then remove the touch cable **7**.



Unplug the connector in the direction shown by arrow **8**, then remove the vibrator board and sensor board **9**.



Locations

Front view and right-side view

- 1 Integrated camera (select models only)
- 2 Multi-touch screen
- 3 Windows button
- 4 Built-in microphones
- 5 Wireless LAN antennas
- 6 Touchpad
- 7 Battery status indicator

Note: For the description of each indicator, see "Status indicators" on page 29.

- 8 Power button
- 9 Novo button
- 10 Screen rotation lock button
- 11 Volume button
- 12 Combo audio jack
- 13 USB port

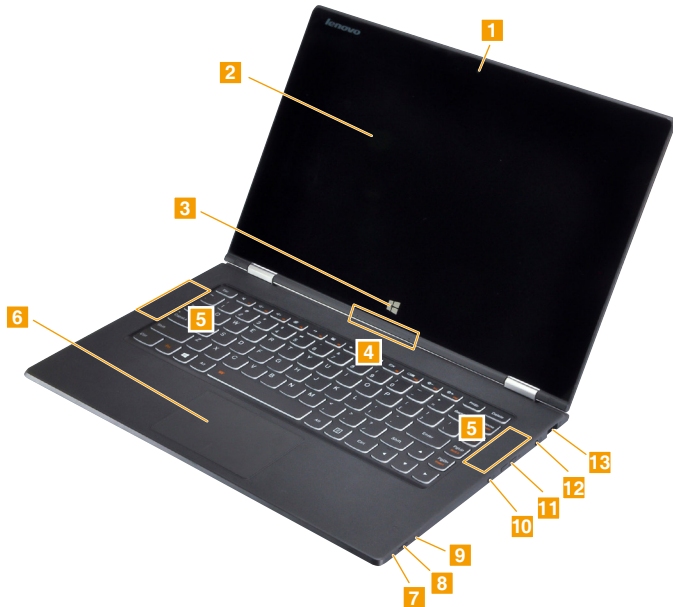

Bottom and Left-side view

- Speaker
- 2 Memory card slot
- 3 HDMI port
- 4 USB port
- 5 AC power adapter jack



Parts list

This section presents the following service parts:

- “Overall” on page 61
- “LCD FRUs” on page 63
- “Keyboard” on page 65
- “Miscellaneous parts” on page 67
- “Screw” on page 67
- “AC adapters” on page 68
- “Power cords” on page 69

Notes:

- Each FRU is available for all types or models, unless specific types or models are specified.

Overall

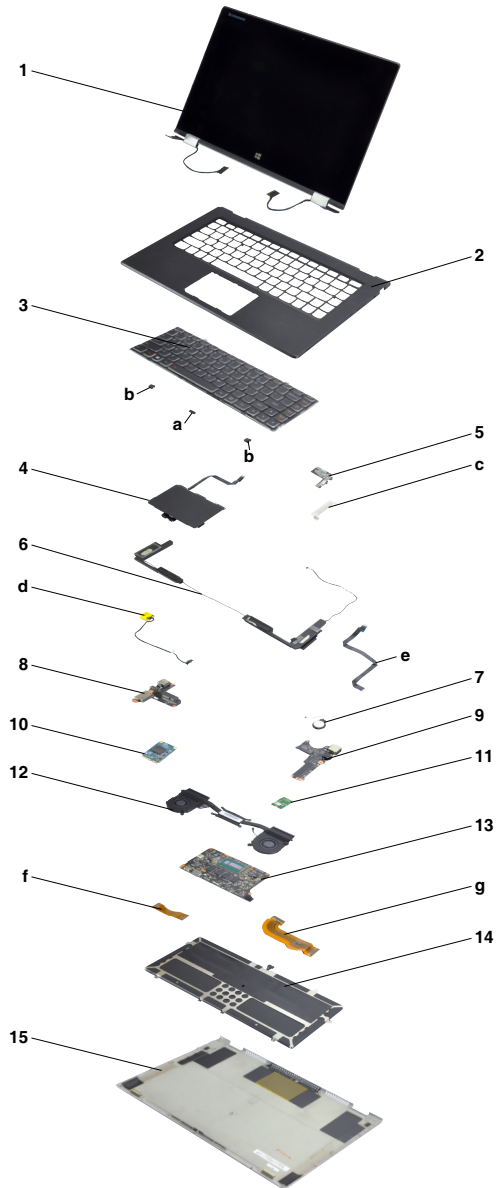

Table 4. Parts list—Overall

No.	FRU	FRU no.	CRU ID.
a-g	See "Miscellaneous parts" on page 67.		
1	LCD unit (see "LCD FRUs" on page 63.)		
2	VIUU3 Upper Case US	90204397	N
2	VIUU3 Upper Case UK	90204398	N
2	VIUU3 Upper Case JP	90204399	N
3	Keyboard (see "Keyboard" on page 65.)		
4	Touchpad, syna TM-02132-001 59x89x0.5 1.1mm	73040855	N
5	VIUU3 Power Board	90004973	N
6	VIUU3 Speaker L+R	90204393	N
7	VIUU3 RTC Barrery	90204392	N
8	VIUU3 SSD Board	90004971	N
9	VIUU3 Audio Board	90004972	N
10	SSD, Samsung PM841 128GB mSATA SSD(TLC)	16200317	N
10	SSD, Toshiba THNSNH128GMCT 128GB mSATA	16200350	N
10	SSD, Samsung PM841-256GB mSATA SSD	16200318	N
10	SSD, Toshiba THNSNH256GMCT 256GB mSATA	16200351	N
10	SSD, Samsung PM841-512GB mSATA SSD	16200355	N
11	WLAN/BT, Intel 7260BN 2x2BN+BT PCIE NGFF WLAN	20200409	N
12	VIUU3 Thermal Module	90204391	N
13	VIUU3 MB UMA I3-4010U 4G	90004977	N
13	VIUU3 MB UMA I5-4200U 4G	90004978	N
13	VIUU3 MB UMA I7-4500U 4G	90004979	N
13	VIUU3 MB UMA I3-4010U 8G	90004980	N
13	VIUU3 MB UMA I5-4200U 8G	90004981	N
13	VIUU3 MB UMA I7-4500U 8G	90004982	N
13	VIUU3 MB W8S UMA I3-4010U 4G	90004983	N
13	VIUU3 MB W8S UMA I5-4200U 4G	90004984	N
13	VIUU3 MB W8S UMA I7-4500U 4G	90004985	N
13	VIUU3 MB W8S UMA I3-4010U 8G	90004986	N
13	VIUU3 MB W8S UMA I5-4200U 8G	90004987	N
13	VIUU3 MB W8S UMA I7-4500U 8G	90004988	N
13	VIUU3 MB W8P UMA I3-4010U 4G	90004989	N
13	VIUU3 MB W8P UMA I5-4200U 4G	90004990	N
13	VIUU3 MB W8P UMA I7-4500U 4G	90004991	N
13	VIUU3 MB W8P UMA I3-4010U 8G	90004992	N
13	VIUU3 MB W8P UMA I5-4200U 8G	90004993	N
13	VIUU3 MB W8P UMA I7-4500U 8G	90004994	N
14	Battery, Yoga2 SP/A L12M4P21 7.4V54Wh 4cell bty	121500156	N
15	VIUU3 Lower Case Orange	90204386	N
15	VIUU3 Lower Case Grey	90204387	N
—	AC adapter (see "AC adapters" on page 68).		

LCD FRUs

In Lenovo Yoga 2 Pro (13"), the type of LCD is 13.3-inch high definition (HD).

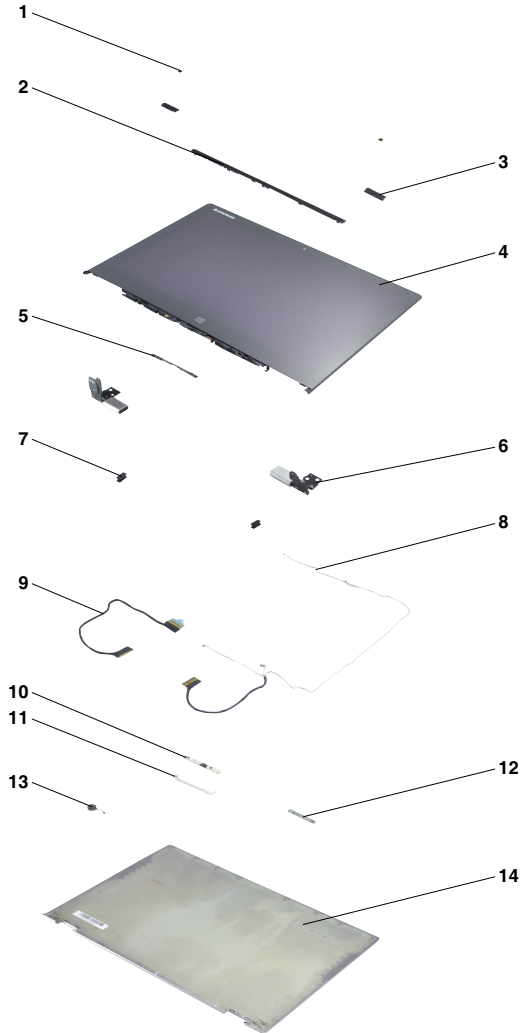

Table 5. Parts list—13.3-inch LCD FRUs

No.	FRU	FRU no.	CRU ID.
1	VIUU3 LCD Bezel Scerw Pad	90204402	N
2	VIUU3 Strip Cover AP0S9000300	90204400	N
3	VIUU3 Hinge Cover	90204401	N
4	VIUU3 LCD Module TS	90400232	N
5	VIUU3 MIC Board	90004974	N
6	VIUU3 Hinge L+R	90204412	N
7	VIUU3 Hinge Rubber	90204403	N
8	VIUU3 Touch Panel Control Cable	90204407	N
9	VIUU3 LCD Cable 40P	90204408	N
10	VIUU3 Camera	90004976	N
11	VIUU3 Camera Bracket EC0S9000700	90204409	N
12	VIUU3 Sensor Board	90204406	N
13	VIUU3 Vibrator Board	90004975	N
14	VIUU3 LCD Cover Orange	90204410	N
14	VIUU3 LCD Cover Grey	90204411	N

Keyboard

Table 6. Parts list—Keyboard

Language		P/N	CRU ID.
OKI Backlight KB	English	25212817	N
	English B	25212818	N
	U.K. English	25212819	N
	Italian	25212820	N
	Spanish	25212821	N
	Turkish	25212822	N
	Thai	25212823	N
	Portuguese	25212824	N
	Latin	25212825	N
	Canadian Bilingual (En+Fr)	25212826	N
	Korean	25212827	N
	Traditional Chinese	25212828	N
	Russian	25212829	N
	French	25212830	N
	German	25212831	N
	Arabic	25212832	N
	Brazilian	25212833	N
	Dutch	25212835	N
	Greek	25212836	N
	Hebrew	25212837	N
	Hungarian	25212838	N
	Nordic	25212839	N
	Belgian	25212840	N
	Icelandic	25212841	N
	Slovenian	25212842	N
	Swiss	25212843	N
US international	25212844	N	
Bulgarian	25212845	N	
Czech&Slovak	25212846	N	
Indic	25212847	N	
Darfon Backlight KB	English	25212848	N
	English B	25212849	N
	U.K. English	25212850	N
	Italian	25212851	N
	Spanish	25212852	N
	Turkish	25212853	N
	Thai	25212854	N
	Portuguese	25212855	N
	Latin	25212856	N
	Canadian Bilingual (En+Fr)	25212857	N
	Korean	25212858	N
	Traditional Chinese	25212859	N
	Russian	25212860	N
	French	25212861	N
	German	25212862	N
	Arabic	25212863	N

Table 6. Parts list—Keyboard (continued)

Language		P/N	CRU ID.
Darfon Backlight KB (continued)	Brazilian	25212864	N
	Japanese	25212865	N
	Dutch	25212866	N
	Greek	25212867	N
	Hebrew	25212868	N
	Hungarian	25212869	N
	Nordic	25212870	N
	Belgian	25212871	N
	Icelandic	25212872	N
	Slovenian	25212873	N
	Swiss	25212874	N
	US international	25212875	N
	Bulgarian	25212876	N
	Czech&Slovak	25212877	N
Indic	25212878	N	

Miscellaneous parts

Table 7. Parts list—Miscellaneous parts

FRU	P/N	CRU ID.
System miscellaneous parts:		
• (a) VIUU3 KB rubber	90204413	
• (b) VIUU3 Upper Case Cable Rubber	90204396	
• (c) VIUU3 Power Board Bracket	90204395	
Cable miscellaneous parts:		
• (d) VIUU3 DC-IN Cable	90204394	N
• (e) VIUU3 Power Board Cable	90204390	
• (f) VIUU3 SSD Cable	90204388	
• (g) VIUU3 Audio Board Cable	90204389	
Note: Italicized letters in parentheses are references to the exploded view in "Overall" on page 61.		

Screw

Table 8. Parts list—screws

FRU	P/N	CRU ID.
VIUU3 Screw M M 2.0D 4.5L K 3.5D 0.5T	90204415	N
VIUU3 SCREW M M 2.0D 4.5L K 4.5D 0.7T	90204416	N
VIUU3 SCREW M M 2.0D 2.5L K 3.5D 0.3T	90204417	N
VIUU3 SCREW M M 2.0D 2.0L K 6.5D 0.7T	90204418	N
VIUU3 SCREW M M 2.0D 3.5L K 3.5D 0.7T	90204419	N
VIUU3 SCREW M M 2.0D 2.5L K 5.0D 0.5T	90204420	N
VIUU3 SCREW M M 2.0D 3.0L K 3.5D 0.5T	90204421	N
VIUU3 SCREW M M 2D 5.0L K 3.5D 0.7T	90204422	N
VIUU3 SCREW M M 2.0D 1.7L K 3.5D 0.3T	90204423	N

AC adapters

Table 9. Parts list—AC adapters

FRU	P/N	CRU ID.
Adapter, 2pin common 65W, Delta ADLX65SDC2A 20V3.25A adapter	36200350	*
Adapter, 2pin common 65W, Liteon ADLX65SLC2A 20V3.25A adapter	36200351	*

Power cords

A Lenovo power cord for a specific country or region is usually available only in that country or region:

Table 10. Parts list—2-pin power cords

Region	P/N	CRU ID.
CCC • LINETEK PC205+RVV 0.75/2C+COC03 1m	145500018	*
ARGENTINA • LINETEK LP40+H03VVH2-F+LS7H 1m	145500030	*
BRAZIL • LINETEK LP25+H03VVH2-F+LS7H 1m	145500028	*
ISRAEL • LINETEK LP45+H03VV-F+LS7 1m	145500029	*
UL • LINETEK LP5+SPT-2 #18/2C+ LS7C 1m	145500021	*
UK • LINETEK LP61L+H03VVH2-F+ LS7H 1m	145500019	*
Indian • LINETEK LP28+IS:694 0.75/2C+ LS7H 1m	145500020	*
Korea • LINETEK LPE03A+H03VVH2-F+LS7 1m	145500025	*
Australia • LINETEK LP15A+H03VVH2-F+LS7 1m	145500023	*
Taiwan • LINETEK LP51A+VCTFK 0.75/2C+LS7J 1m	145500027	*
Japan • LINETEK LP51A+HVCTFK 0.75/2C+LS7J 1m	145500026	*
Africa • LINETEK PE364("O")+H03VVH2-F+LS7H 1m	145500024	*
CE • LINETEK LP21+H03VVH2-F+ LS7 1m	145500022	*
CCC • Longwell LSG-21+RVV300/300+LS-72 1m	145500069	*
ARGENTINA • Longwell LP-16+H03VVH2-F+LS-7 1m	145500070	*
BRAZIL • Longwell LP-18A+H03VVH2-F+LS-18 1m	145500071	*
ISRAEL • Longwell LP-55+H03VVH2-F+LS-7 1m	145500072	*
UL • Longwell LP-11+SPT-2+LS-7C/7J 1m	145500073	*
UK • Longwell LP-61L+H03VVH2-F+ LS-7 1m	145500074	*
Indian • Longwell LP-77+Longwell-p 2X+LS-7 1m	145500075	*
Korea • Longwell LP-57+H03VVH2-F+LS-7KS 1m	145500076	*

Table 10. Parts list—2-pin power cords (continued)

Region	P/N	CRU ID.
Australia • Longwell LP-15A+LFC-2F+LS-7 1m	145500077	*
Taiwan • Longwell LP-70+VCTFK+LS-31 1m	145500078	*
Japan • Longwell LP-51A+VCTFK+LS-7C/7J 1m	145500079	*
Africa • Longwell LP-39+H03VVH2-F+LS-7 1m	145500080	*
CE • Longwell LP-21+ H03VVH2-F+LS-7 1m	145500081	*

Notices

Lenovo may not offer the products, services, or features discussed in this document in all countries. Consult your local Lenovo representative for information on the products and services currently available in your area. Any reference to a Lenovo product, program, or service is not intended to state or imply that only that Lenovo product, program, or service may be used. Any functionally equivalent product, program, or service that does not infringe any Lenovo intellectual property right may be used instead. However, it is the user's responsibility to evaluate and verify the operation of any other product, program, or service.

Lenovo may have patents or pending patent applications covering subject matter described in this document. The furnishing of this document does not give you any license to these patents.

LENOVO GROUP LTD. PROVIDES THIS PUBLICATION "AS IS" WITHOUT WARRANTY OF ANY KIND, EITHER EXPRESS OR IMPLIED, INCLUDING, BUT NOT LIMITED TO, THE IMPLIED WARRANTIES OF NON-INFRINGEMENT, MERCHANTABILITY OR FITNESS FOR A PARTICULAR PURPOSE. Some jurisdictions do not allow disclaimer of express or implied warranties in certain transactions, therefore, this statement may not apply to you.

This information could include technical inaccuracies or typographical errors. Changes are periodically made to the information herein; these changes will be incorporated in new editions of the publication. Lenovo may make improvements and/or changes in the product(s) and/or the program(s) described in this publication at any time without notice.

The products described in this document are not intended for use in implantation or other life support applications where malfunction may result in injury or death to persons. The information contained in this document does not affect or change Lenovo product specifications or warranties. Nothing in this document shall operate as an express or implied license or indemnity under the intellectual property rights of Lenovo or third parties. All information contained in this document was obtained in specific environments and is presented as an illustration. The result obtained in other operating environments may vary.

Lenovo may use or distribute any of the information you supply in any way it believes appropriate without incurring any obligation to you.

Any references in this publication to non-Lenovo Web sites are provided for convenience only and do not in any manner serve as an endorsement of those Web sites. The materials at those Web sites are not part of the materials for this Lenovo product, and use of those Web sites is at your own risk.

Any performance data contained herein was determined in a controlled environment. Therefore, the result obtained in other operating environments may vary significantly. Some measurements may have been made on development-level systems and there is no guarantee that these measurements will be the same on generally available systems. Furthermore, some measurements may have been estimated through extrapolation. Actual results may vary. Users of this document should verify the applicable data for their specific environment.

Trademarks

The following terms are either registered trademarks or trademarks of Lenovo in the United States and/or other countries:

- Lenovo®
- Lenovo logo®
- VeriFace®
- OneKey Rescue® (OneKey Recovery, OneKey Antivirus)
- APS®
- Power Express®
- Energy Management and ReadyComm®

The following terms are trademarks of Microsoft Corporation in the United States, other countries, or both:

- Windows®
- Windows® 7
- Windows® 8

The following are trademarks of Intel Corporation or its subsidiaries in the United States, other countries, or both:

- Intel®
- Intel® Core™ 2 Duo

The following is a trademark of Advanced Micro Devices, Inc. AMD®

Other company, product, or service names may be the trademarks or service marks of others.