

## Features

- Epitaxial Planar Die Construction
- Complementary NPN Type Available (MMBT4401)
- Ideal for Medium Power Amplification and Switching
- **Totally Lead-Free & Fully RoHS compliant (Notes 1 & 2)**
- **Halogen and Antimony Free. "Green" Device (Note 3)**
- **Qualified to AEC-Q101 Standards for High Reliability**

## Mechanical Data

- Case: SOT23
- UL Flammability Rating 94V-0
- Case material: molded Plastic "Green" Compound
- Moisture Sensitivity: Level 1 per J-STD-020
- Terminals: Matte Tin Finish
- Weight: 0.008 grams (Approximate)

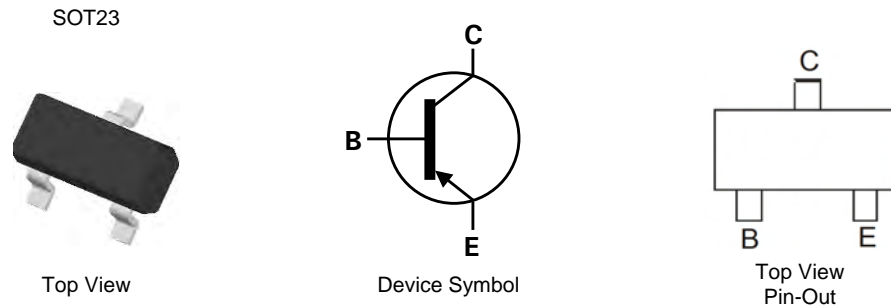

## Ordering Information (Note 4)

Product	Marking	Reel size (inches)	Tape width (mm)	Quantity per reel
MMBT4403-7-F	K2T	7	8	3,000
MMBT4403-13-F	K2T	13	8	10,000

- Notes:
1. No purposely added lead. Fully EU Directive 2002/95/EC (RoHS) & 2011/65/EU (RoHS 2) compliant.
  2. See <http://www.diodes.com> for more information about Diodes Incorporated's definitions of Halogen and Antimony free, "Green" and Lead-Free.
  3. Halogen and Antimony free "Green" products are defined as those which contain <900ppm bromine, <900ppm chlorine (<1500ppm total Br + Cl) and <1000ppm antimony compounds.
  4. For packaging details, go to our website at <http://www.diodes.com>

## Marking Information

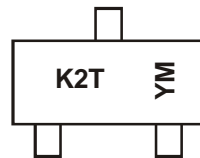

K2T = Product Type Marking Code  
 YM = Date Code Marking  
 Y = Year (ex: Y = 2011)  
 M = Month (ex: 9 = September)

### Date Code Key

Year	2010	2011	2012	2013	2014	2015	2016	2017
Code	X	Y	Z	A	B	C	D	E

Month	Jan	Feb	Mar	Apr	May	Jun	Jul	Aug	Sep	Oct	Nov	Dec
Code	1	2	3	4	5	6	7	8	9	O	N	D

**Maximum Ratings** (@T<sub>A</sub> = +25°C, unless otherwise specified.)

Characteristic	Symbol	Value	Unit
Collector-Base Voltage	V <sub>CBO</sub>	-40	V
Collector-Emitter Voltage	V <sub>CEO</sub>	-40	V
Emitter-Base Voltage	V <sub>EBO</sub>	-6.0	V
Collector Current - Continuous (Note 7)	I <sub>C</sub>	-600	mA

**Thermal Characteristics** (@T<sub>A</sub> = +25°C, unless otherwise specified.)

Characteristic	Symbol	Value	Unit
Collector Power Dissipation	P <sub>D</sub>	(Note 5)	310
		(Note 6)	350
Thermal Resistance, Junction to Ambient	R <sub>θJA</sub>	(Note 5)	403
		(Note 6)	357
Thermal Resistance, Junction to Leads	R <sub>θJL</sub>	350	°C/W
Operating and Storage Temperature Range	T <sub>J</sub> , T <sub>STG</sub>	-55 to +150	°C

- Notes:
- 5. For the device mounted on minimum recommended pad layout FR4 PCB with high coverage of single sided 1oz copper, in still air conditions.
  - 6. For the device mounted on 15mm x 15mm x 1.6mm FR4 PCB with high coverage of single sided 1oz copper, in still air conditions.
  - 7. Thermal resistance from junction to solder-point (at the end of the collector lead).

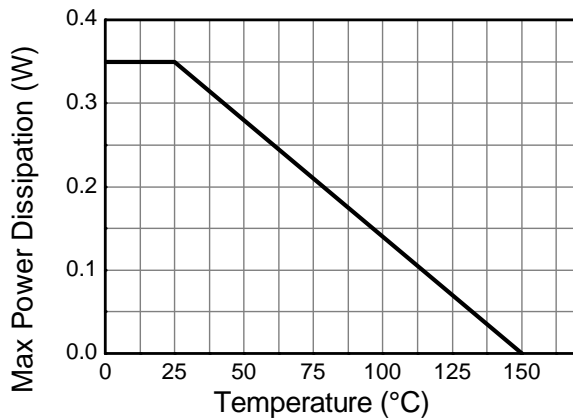

**Derating Curve**

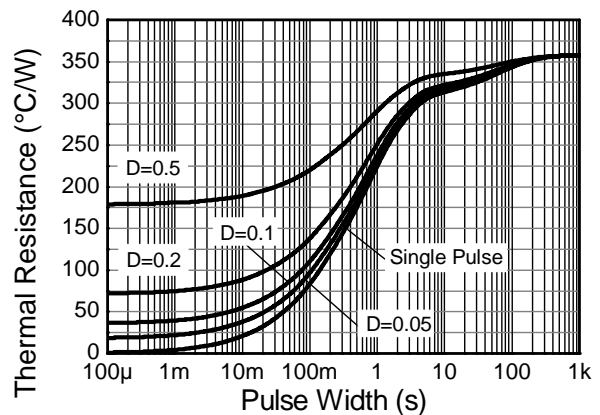

**Transient Thermal Impedance**

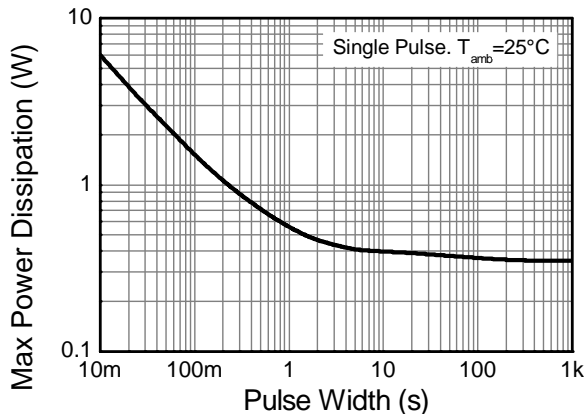

**Pulse Power Dissipation**

**Electrical Characteristics** (@T<sub>A</sub> = +25°C, unless otherwise specified.)

Characteristic	Symbol	Min	Max	Unit	Test Condition	
<b>OFF CHARACTERISTICS (Note 8)</b>						
Collector-Base Breakdown Voltage	BV <sub>CBO</sub>	-40	—	V	I <sub>C</sub> = -100μA, I <sub>E</sub> = 0	
Collector-Emitter Breakdown Voltage	BV <sub>CEO</sub>	-40	—	V	I <sub>C</sub> = -10.0mA, I <sub>B</sub> = 0	
Emitter-Base Breakdown Voltage	BV <sub>EBO</sub>	-6.0	—	V	I <sub>E</sub> = -100μA, I <sub>C</sub> = 0	
Collector Cutoff Current	I <sub>CEX</sub>	—	-100	nA	V <sub>CE</sub> = -35V, V <sub>EB(OFF)</sub> = -0.4V	
Base Cutoff Current	I <sub>BL</sub>	—	-100	nA	V <sub>CE</sub> = -35V, V <sub>EB(OFF)</sub> = -0.4V	
<b>ON CHARACTERISTICS (Note 8)</b>						
DC Current Gain	h <sub>FE</sub>	30	—	—	I <sub>C</sub> = -100μA, V <sub>CE</sub> = -1.0V	
		60	—			I <sub>C</sub> = -1.0mA, V <sub>CE</sub> = -1.0V
		100	—			I <sub>C</sub> = -10mA, V <sub>CE</sub> = -1.0V
		100	300			I <sub>C</sub> = -150mA, V <sub>CE</sub> = -2.0V
		20	—			I <sub>C</sub> = -500mA, V <sub>CE</sub> = -2.0V
Collector-Emitter Saturation Voltage	V <sub>CE(sat)</sub>	—	-0.40 -0.75	V	I <sub>C</sub> = -150mA, I <sub>B</sub> = -15mA I <sub>C</sub> = -500mA, I <sub>B</sub> = -50mA	
Base-Emitter Saturation Voltage	V <sub>BE(sat)</sub>	-0.75 —	-0.95 -1.30	V	I <sub>C</sub> = -150mA, I <sub>B</sub> = -15mA I <sub>C</sub> = -500mA, I <sub>B</sub> = -50mA	
<b>SMALL SIGNAL CHARACTERISTICS</b>						
Output Capacitance	C <sub>obo</sub>	—	8.5	pF	V <sub>CB</sub> = -10V, f = 1.0MHz, I <sub>E</sub> = 0	
Input Capacitance	C <sub>ibo</sub>	—	30	pF	V <sub>EB</sub> = -0.5V, f = 1.0MHz, I <sub>C</sub> = 0	
Input Impedance	h <sub>ie</sub>	1.5	15	kΩ	V <sub>CE</sub> = -10V, I <sub>C</sub> = -1.0mA, f = 1.0kHz	
Voltage Feedback Ratio	h <sub>re</sub>	0.1	8.0	x 10 <sup>-4</sup>		
Small Signal Current Gain	h <sub>fe</sub>	60	500	—		
Output Admittance	h <sub>oe</sub>	1.0	100	μS		
Current Gain-Bandwidth Product	f <sub>T</sub>	200	—	MHz	V <sub>CE</sub> = -10V, I <sub>C</sub> = -20mA, f = 100MHz	
<b>SWITCHING CHARACTERISTICS</b>						
Delay Time	t <sub>d</sub>	—	15	ns	V <sub>CC</sub> = -30V, I <sub>C</sub> = -150mA,	
Rise Time	t <sub>r</sub>	—	20	ns	V <sub>BE(off)</sub> = -2.0V, I <sub>B1</sub> = -15mA	
Storage Time	t <sub>s</sub>	—	225	ns	V <sub>CC</sub> = -30V, I <sub>C</sub> = -150mA,	
Fall Time	t <sub>f</sub>	—	30	ns	I <sub>B1</sub> = I <sub>B2</sub> = -15mA	

Notes: 8. Short duration pulse test used to minimize self-heating effect.

**Typical Electrical Characteristics**

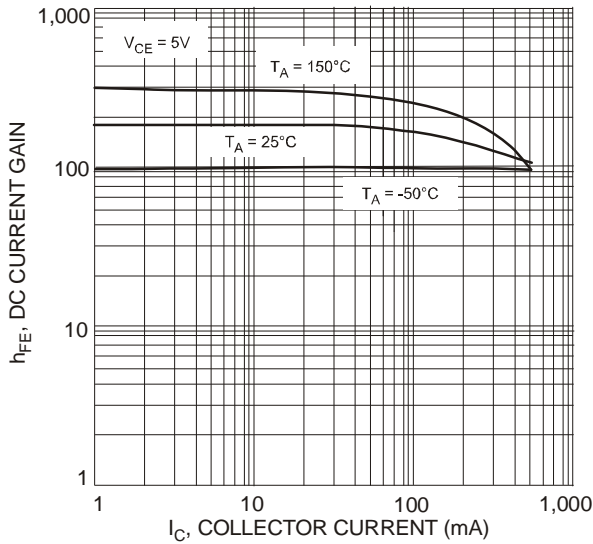

Figure 1 Typical DC Current Gain vs. Collector Current

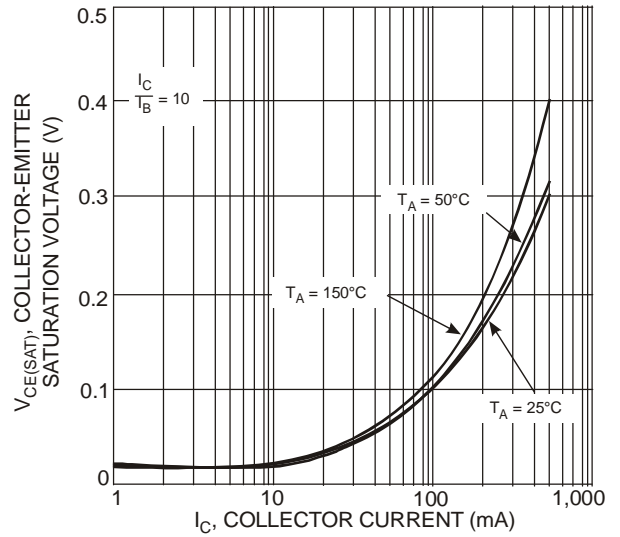

Figure 2 Typical Collector-Emitter Saturation Voltage vs. Collector Current

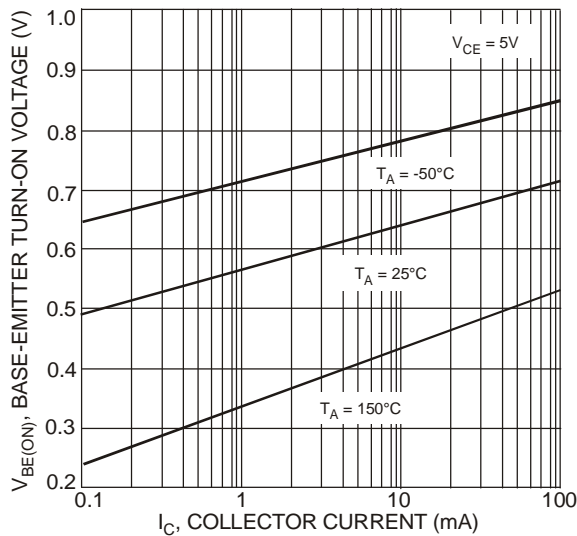

Figure 3 Typical Base-Emitter Turn-On Voltage vs. Collector Current

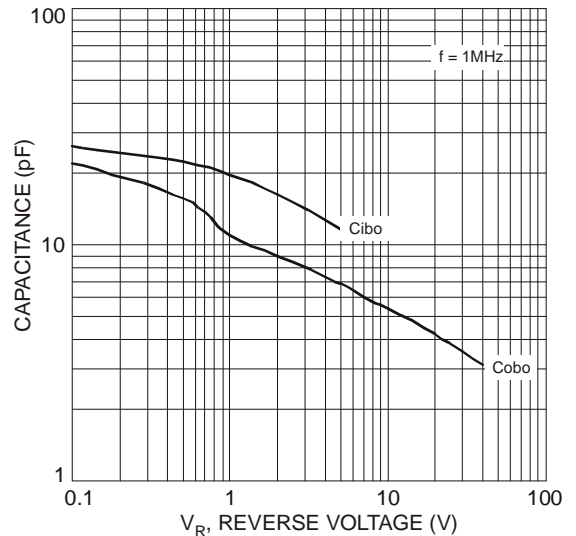

Figure 4 Typical Capacitance Characteristics

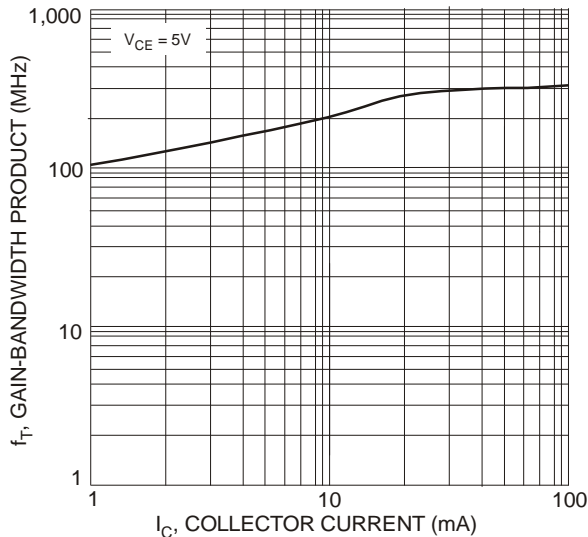

Figure 5 Typical Gain-Bandwidth Product vs. Collector Current

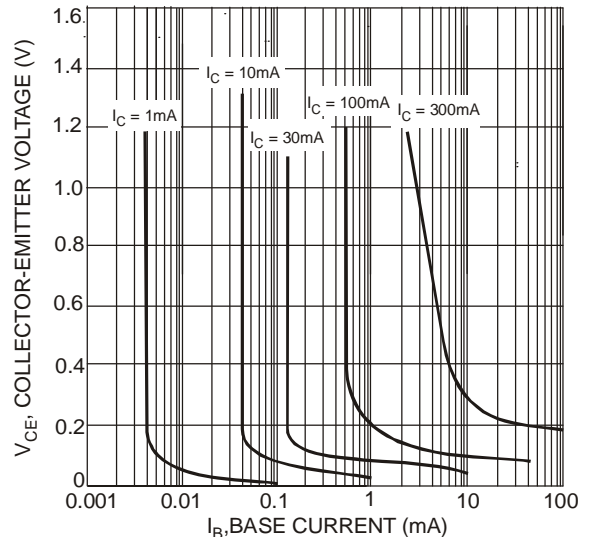
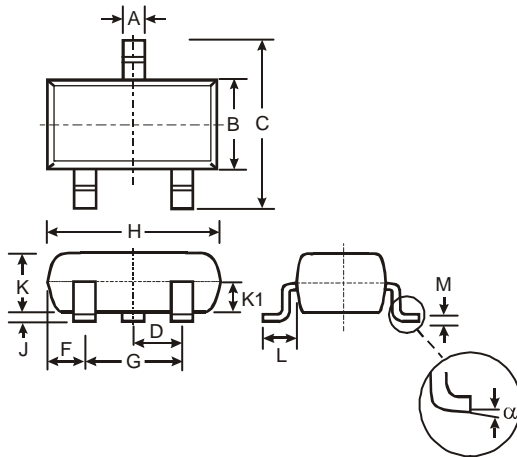

Figure 6 Typical Collector Saturation Region

**Package Outline Dimensions**

Please see AP02002 at <http://www.diodes.com/datasheets/ap02002.pdf> for latest version.



SOT23			
Dim	Min	Max	Typ
A	0.37	0.51	0.40
B	1.20	1.40	1.30
C	2.30	2.50	2.40
D	0.89	1.03	0.915
F	0.45	0.60	0.535
G	1.78	2.05	1.83
H	2.80	3.00	2.90
J	0.013	0.10	0.05
K	0.903	1.10	1.00
K1	-	-	0.400
L	0.45	0.61	0.55
M	0.085	0.18	0.11
α	0°	8°	-

**All Dimensions in mm**

**Suggested Pad Layout**

Please see AP02001 at <http://www.diodes.com/datasheets/ap02001.pdf> for the latest version.

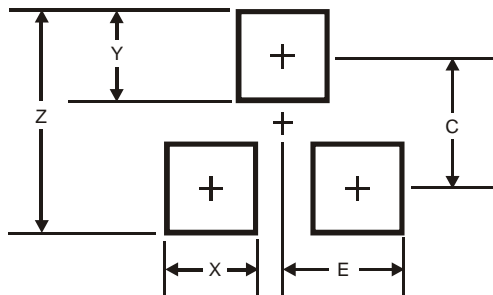

Dimensions	Value (in mm)
Z	2.9
X	0.8
Y	0.9
C	2.0
E	1.35

**IMPORTANT NOTICE**

DIODES INCORPORATED MAKES NO WARRANTY OF ANY KIND, EXPRESS OR IMPLIED, WITH REGARDS TO THIS DOCUMENT, INCLUDING, BUT NOT LIMITED TO, THE IMPLIED WARRANTIES OF MERCHANTABILITY AND FITNESS FOR A PARTICULAR PURPOSE (AND THEIR EQUIVALENTS UNDER THE LAWS OF ANY JURISDICTION).

Diodes Incorporated and its subsidiaries reserve the right to make modifications, enhancements, improvements, corrections or other changes without further notice to this document and any product described herein. Diodes Incorporated does not assume any liability arising out of the application or use of this document or any product described herein; neither does Diodes Incorporated convey any license under its patent or trademark rights, nor the rights of others. Any Customer or user of this document or products described herein in such applications shall assume all risks of such use and will agree to hold Diodes Incorporated and all the companies whose products are represented on Diodes Incorporated website, harmless against all damages.

Diodes Incorporated does not warrant or accept any liability whatsoever in respect of any products purchased through unauthorized sales channel. Should Customers purchase or use Diodes Incorporated products for any unintended or unauthorized application, Customers shall indemnify and hold Diodes Incorporated and its representatives harmless against all claims, damages, expenses, and attorney fees arising out of, directly or indirectly, any claim of personal injury or death associated with such unintended or unauthorized application.

Products described herein may be covered by one or more United States, international or foreign patents pending. Product names and markings noted herein may also be covered by one or more United States, international or foreign trademarks.

**LIFE SUPPORT**

Diodes Incorporated products are specifically not authorized for use as critical components in life support devices or systems without the express written approval of the Chief Executive Officer of Diodes Incorporated. As used herein:

- A. Life support devices or systems are devices or systems which:
  - 1. are intended to implant into the body, or
  - 2. support or sustain life and whose failure to perform when properly used in accordance with instructions for use provided in the labeling can be reasonably expected to result in significant injury to the user.
- B. A critical component is any component in a life support device or system whose failure to perform can be reasonably expected to cause the failure of the life support device or to affect its safety or effectiveness.

Customers represent that they have all necessary expertise in the safety and regulatory ramifications of their life support devices or systems, and acknowledge and agree that they are solely responsible for all legal, regulatory and safety-related requirements concerning their products and any use of Diodes Incorporated products in such safety-critical, life support devices or systems, notwithstanding any devices- or systems-related information or support that may be provided by Diodes Incorporated. Further, Customers must fully indemnify Diodes Incorporated and its representatives against any damages arising out of the use of Diodes Incorporated products in such safety-critical, life support devices or systems.

Copyright © 2012, Diodes Incorporated

[www.diodes.com](http://www.diodes.com)

# Mouser Electronics

Authorized Distributor

Click to View Pricing, Inventory, Delivery & Lifecycle Information:

[Diodes Incorporated:](#)

[MMBT4403-7-F](#)