

# Haier

# SERVICE MANUAL

Order No.AC1101S020V0

## Wall mounted Type DC Inverter EA-Series Model No. HSU09VHJ(DB)



### **WARNING**

This service information is designed for experienced repair technicians only and is not designed for use by the general public. It does not contain warnings or cautions to advise non-technical individuals of potential dangers in attempting to service a product. Products powered by electricity should be serviced or repaired only by experienced professional technicians. Any attempt to service or repair the product or products dealt with in this service information by anyone else could result in serious injury or death

©2011(Qingdao Haier Air Conditioner General corp.,Ltd)  
All right reserved .Unauthorized copying and distribution is a violation of law

## Haier Group

# Table of Contents

<b>1. Introduction</b> .....	1
<b>2. List of Functions</b> .....	6
<b>3. Specifications</b> .....	7
<b>4. Printed Circuit Board Connector Wiring Diagram</b> .....	9
<b>5. Functions and Control</b> .....	14
5.1 Main functions and control specifications of indoor unit .....	14
5.2 Main functions and control specifications of outdoor unit .....	20
5.3 Function of main thermistor .....	25
5.4 Value of thermistor .....	26
<b>6. System Configuration</b> .....	41
6.1 System Configuration.....	41
6.2 Instruction.....	41
<b>7. Service Diagnosis</b> .....	49
7.1 Caution for diagnosis.....	49
7.2 Problem Symptoms and Measures .....	49
7.3 Error codes and description indoor display .....	50
<b>8. Installations</b> .....	66
<b>9. Removal Procedure</b> .....	70
9.1 For indoor unit .....	70
9.2 For outdoor unit .....	82
<b>10. Wiring Diagrams</b> .....	91
10.1 Indoor Unit .....	91
10.2 Outdoor Unit .....	92
<b>11. Circuit Diagrams</b> .....	93
<b>12. Description of Coding rules of Unit Model</b> .....	97

# 1. Introduction

## 1.1 Safety Cautions

Be sure to read the following safety cautions before conducting repair work.

The caution items are classified into “Warning” and “Caution”. The “Warning” items are especially important since they can lead to death or serious injury if they are not followed closely. The “Caution” items can also lead to serious accidents under some conditions if they are not followed. Therefore, be sure to observe all the safety caution items described below.

About the pictograms

△ This symbol indicates an item for which caution must be exercised.

The pictogram shows the item to which attention must be paid.

○ This symbol indicates a prohibited action.





The prohibited item or action is shown inside or near the symbol.







● This symbol indicates an action that must be taken, or an instruction.

The instruction is shown inside or near the symbol.

After the repair work is complete, be sure to conduct a test operation to ensure that the equipment operates normally, and explain the cautions for operating the product to the customer.



### 1.1.1 Caution in Repair

Warning	
<p>Be sure to disconnect the power cable plug from the plug socket before disassembling the equipment for a repair.</p> <p>Working on the equipment that is connected to a power supply can cause an electrical shock.</p> <p>If it is necessary to supply power to the equipment to conduct the repair or inspecting the circuits, do not touch any electrically charged sections of the equipment.</p>	
<p>If the refrigerant gas discharges during the repair work, do not touch the discharging refrigerant gas. The refrigerant gas can cause frostbite.</p>	
<p>When disconnecting the suction or discharge pipe of the compressor at the welded section, release the refrigerant gas completely at a well-ventilated place first.</p> <p>If there is a gas remaining inside the compressor, the refrigerant gas or refrigerating machine oil discharges when the pipe is disconnected, and it can cause injury.</p>	
<p>If the refrigerant gas leaks during the repair work, ventilate the area. The refrigerant gas can generate toxic gases when it contacts flames.</p>	
<p>The step-up capacitor supplies high-voltage electricity to the electrical components of the outdoor unit.</p> <p>Be sure to discharge the capacitor completely before conducting repair work. A charged capacitor can cause an electrical shock.</p>	
<p>Do not start or stop the air conditioner operation by plugging or unplugging the power cable plug.</p> <p>Plugging or unplugging the power cable plug to operate the equipment can cause an electrical shock or fire.</p>	

Warning	
Do not repair the electrical components with wet hands. Working on the equipment with wet hands can cause an electrical shock.	
Do not clean the air conditioner by splashing water. Washing the unit with water can cause an electrical shock.	
Be sure to provide the grounding when repairing the equipment in a humid or wet place, to avoid electrical shocks.	
Be sure to turn off the power switch and unplug the power cable when cleaning the equipment. The internal fan rotates at a high speed, and cause injury.	
Do not tilt the unit when removing it. The water inside the unit can spill and wet the furniture and floor.	
Be sure to check that the refrigerating cycle section has cooled down sufficiently before conducting repair work. Working on the unit when the refrigerating cycle section is hot can cause burns.	
Use the welder in a well-ventilated place. Using the welder in an enclosed room can cause oxygen deficiency.	



### 1.1.2 Cautions Regarding Products after Repair

Warning	
Be sure to use parts listed in the service parts list of the applicable model and appropriate tools to conduct repair work. Never attempt to modify the equipment. The use of inappropriate parts or tools can cause an electrical shock, excessive heat generation or fire.	
When relocating the equipment, make sure that the new installation site has sufficient strength to withstand the weight of the equipment. If the installation site does not have sufficient strength and if the installation work is not conducted securely, the equipment can fall and cause injury.	
Be sure to install the product correctly by using the provided standard installation frame. Incorrect use of the installation frame and improper installation can cause the equipment to fall, resulting in injury.	For integral units only
Be sure to install the product securely in the installation frame mounted on a window frame. If the unit is not securely mounted, it can fall and cause injury.	For integral units only

Warning	
<p>Be sure to use an exclusive power circuit for the equipment, and follow the technical standards related to the electrical equipment, the internal wiring regulations and the instruction manual for installation when conducting electrical work.</p> <p>Insufficient power circuit capacity and improper electrical work can cause an electrical shock or fire.</p>	
<p>Be sure to use the specified cable to connect between the indoor and outdoor units. Make the connections securely and route the cable properly so that there is no force pulling the cable at the connection terminals.</p> <p>Improper connections can cause excessive heat generation or fire.</p>	
<p>When connecting the cable between the indoor and outdoor units, make sure that the terminal cover does not lift off or dismount because of the cable.</p> <p>If the cover is not mounted properly, the terminal connection section can cause an electrical shock, excessive heat generation or fire.</p>	
<p>Do not damage or modify the power cable.</p> <p>Damaged or modified power cable can cause an electrical shock or fire. Placing heavy items on the power cable, and heating or pulling the power cable can damage the cable.</p>	
<p>Do not mix air or gas other than the specified refrigerant (R-410A / R22) in the refrigerant system.</p> <p>If air enters the refrigerating system, an excessively high pressure results, causing equipment damage and injury.</p>	
<p>If the refrigerant gas leaks, be sure to locate the leak and repair it before charging the refrigerant. After charging refrigerant, make sure that there is no refrigerant leak.</p> <p>If the leak cannot be located and the repair work must be stopped, be sure to perform pump-down and close the service valve, to prevent the refrigerant gas from leaking into the room. The refrigerant gas itself is harmless, but it can generate toxic gases when it contacts flames, such as fan and other heaters, stoves and ranges.</p>	
<p>When replacing the coin battery in the remote controller, be sure to disposed of the old battery to prevent children from swallowing it.</p> <p>If a child swallows the coin battery, see a doctor immediately.</p>	

Caution	
<p>Installation of a leakage breaker is necessary in some cases depending on the conditions of the installation site, to prevent electrical shocks.</p>	
<p>Do not install the equipment in a place where there is a possibility of combustible gas leaks.</p> <p>If a combustible gas leaks and remains around the unit, it can cause a fire.</p>	
<p>Be sure to install the packing and seal on the installation frame properly. If the packing and seal are not installed properly, water can enter the room and wet the furniture and floor.</p>	For integral units only

### 1.1.3 Inspection after Repair

Warning	
<p>Check to make sure that the power cable plug is not dirty or loose, then insert the plug into a power outlet all the way.</p> <p>If the plug has dust or loose connection, it can cause an electrical shock or fire.</p>	
<p>If the power cable and lead wires have scratches or deteriorated, be sure to replace them.</p> <p>Damaged cable and wires can cause an electrical shock, excessive heat generation or fire.</p>	





Warning	
<p>Do not use a joined power cable or extension cable, or share the same power outlet with other electrical appliances, since it can cause an electrical shock, excessive heat generation or fire.</p>	

Caution	
<p>Check to see if the parts and wires are mounted and connected properly, and if the connections at the soldered or crimped terminals are secure. Improper installation and connections can cause excessive heat generation, fire or an electrical shock.</p>	
<p>If the installation platform or frame has corroded, replace it. Corroded installation platform or frame can cause the unit to fall, resulting in injury.</p>	
<p>Check the grounding, and repair it if the equipment is not properly grounded. Improper grounding can cause an electrical shock.</p>	
<p>Be sure to measure the insulation resistance after the repair, and make sure that the resistance is 1 M ohm or higher.</p> <p>Faulty insulation can cause an electrical shock.</p>	
<p>Be sure to check the drainage of the indoor unit after the repair.</p> <p>Faulty drainage can cause the water to enter the room and wet the furniture and floor.</p>	

### 1.1.4 Using Icons

Icons are used to attract the attention of the reader to specific information. The meaning of each icon is described in the table below:

### 1.1.5 Using Icons List

Icon	Type of Information	Description
 Note:	Note	A "note" provides information that is not indispensable, but may nevertheless be valuable to the reader, such as tips and tricks.
 Caution	Caution	A "caution" is used when there is danger that the reader, through incorrect manipulation, may damage equipment, lose data, get an unexpected result or has to restart (part of) a procedure.
 Warning	Warning	A "warning" is used when there is danger of personal injury.
	Reference	A "reference" guides the reader to other places in this binder or in this manual, where he/she will find additional information on a specific topic.

## 2. List of Functions

Category	Functions	HSU09VHJ(DB)
Healthy negative ion	make your room full of an abundance natural negative ions.	Y
Left&right flow	With specialized motor and flaps, the airflow can be adjusted .	N
Child lock	Avoid the child's wrong operation on the remote controller	Y
3D air flow	The 3D airflow is able to deliver the airflow horizontally and vertically.	N
24Hour timer	Use the timer function to set on,or off,or from on to off,or from off to on	Y
Auto restart	automatic return to previous operation conditions after asudden power blackou	Y
Easy clean design	The panel is easy to wash and the airflow vents can be detached easily	Y
Intelligent air	With single-blade technology ,the airflow can be adjusted not to blow directly	Y
Anti-mold filter	Catches most small particles and remove unpleasant odors effectively.	Y
Sleep mode	The setting temprature and the indoor noise can be adjusted to a more comfortable level when you set the "sleep mode"during night sleep	Y
4 Fan setting	Select the fan speed LO,MED,HI,AUTO	Y
Entire auto mode	You can set a temprature value,with which the unit can be adjusted the operation mode automatically	Y
Auto mode	adjust the last fixed operation mode automatically.	N
ESF filter	Trap harmful dust and remove unpleasant odors effectively	N
Power mode	Quick cooling or heating	Y
Soft mode	lower noise operation condition	Y
Negative ion filter	Generate negative ions by the filter.	N
Constant temperature dehumidification	Make dehumidifying in the room while keeping the constant temperature inside	N

Note: Y: Holding Functions

N : No Functions



### 3. Specifications

Model			HSU09VHJ(DB)	
			Cooling	Heating
Capacity Rated (Min.~Max.)	kW		2.64(0.88-3.22)	2.78(0.88-3.52)
	kJ		9495(3165-11605)	10023(3165-12660)
	kcal/h		2268(756-2772)	2394(756-3024)
Moisture Removal	pints/hr		2.65	—
Running Current (Rated)	A		4.4	4.9
Power Consumption Rated (Min.~Max.)	W		690(180-1400)	770(250-1400)
Power Factor	%		98	98
SEER/HSPF			16.8	9.5
Piping Connections	Liquid	inches	φ 1/4	
	Gas	inches	φ 3/8	
	Drain	inches	φ 5/8	
Heat Insulation			Both Liquid and Gas Pipes	
Max. Interunit Piping Length	feet		49 3/16	
Max. Interunit Height Difference	feet		32 13/16	
Chargeless	feet		22 15/16	
Amount of Additional Charge of Refrigerant	OZ/inches		0.018	
<b>Indoor Unit</b>				
Front Panel Color			White	
Air Flow Rate	m <sup>3</sup> /min(cfm)	H	7	7
		M	6	6
		L	5	5
		SL	4.2	4.2
Fan	Type		Cross Flow Fan	
	Motor Output	W	30	
	Speed	Steps	4 Steps, Auto	
Air Direction Control			Horizontal, Downward	
Air Filter			Removable / Washable / Mildew Proof	
Running Current (Rated)	A		0.15	0.15
Power Consumption (Rated)	W		33	33
Temperature Control			Microcomputer Control	
Dimensions (H×W×D)	inches		36 15/16 x 7 3/8 x 10 7/16	
Packaged Dimensions (H×W×D)	inches		33 x 10 13/16 x 13	
Weight	lbs		20.72	
Gross Weight	lbs		24.25	
OperationSound	H/M/L	dBA	41/40/39	
Sound Power	H	dBA	51	51

Outdoor Unit				
Casing Color			White	
Compressor	Type		Rotary Compressor	
	Model		DA89X1C-20FZ	
	Motor Output	W	690	
RefrigerantOil	Model		ESTER OIL VG74	
	Charge	pints	0.65	
Refrigerant	Model		R410a	
	Charge	oz	33.5	
Air Flow Rate (H/L)	m <sup>3</sup> /min		31.6	31.6
	cfm		1115	1115
Fan	Type		Propeller	
	Motor Output	W	40	
Running Current (Rated)		A	3.8	4.2
Power Consumption (Rated)		W	670	740
Power Factor		%	98	98
Starting Current		A	6	
Dimensions (H×W×D)		inches	30 11/16 x9 5/8 x 21 1/4	
Packaged Dimensions (H×W×D)		inches	36 8/5 x13 3/8 x 24 3/16	
Weight		lbs	70.99	
Gross Weight		lbs	77.16	
OperationSound	H/L	dBA	55	55
Sound Power	H	dBA	65	65

Note: The data are based on the conditions shown in the table below.

Cooling	Heating	Piping Length
Indoor ; 80° FDB/67° FWB Outdoor ; 95° FDB/75° FWB	Indoor ; 70° FDB/60° FWB Outdoor; 47° FDB/47° FWB	16 2/5 feet

Conversion Formulae
kcal/h=kW×860
Btu/h=kW×3414
cfm=m <sup>3</sup> /min×35.3

## 4. Printed Circuit Board Connector Wiring Diagram

### 4.1 : Indoor unit Connectors

#### Connectors

##### PCB(1) (Control PCB)

- 1) CN26 Connector for fan motor
- 2) CN11 Connector for STEP motor
- 3) CN8 Connector for heat exchanger thermistor and Room temperature thermistor
- 4) CN27 Connector for fan feedback
- 5) CH1 Connector for power L wire
- 6) CON2 Connector for power N wire
- 7) CON7 Connector for communicate wire
- 8) CN30 Connector for transformer input
- 9) CN31 Connector for transformer output
- 10) CN32 Connector for display board

#### **Note: Other designations**

##### PCB(1) (INdoor Control PCB)

- 1) CN48 Connector for Forced operation ON / OFF switch
- 2) J1 Select 25 or 35
- 3) LED1 communicate display light
- 4) RV1 Varistor
- 5) FUSE1 Fuse 3.15A/250VAC

PCB(1)

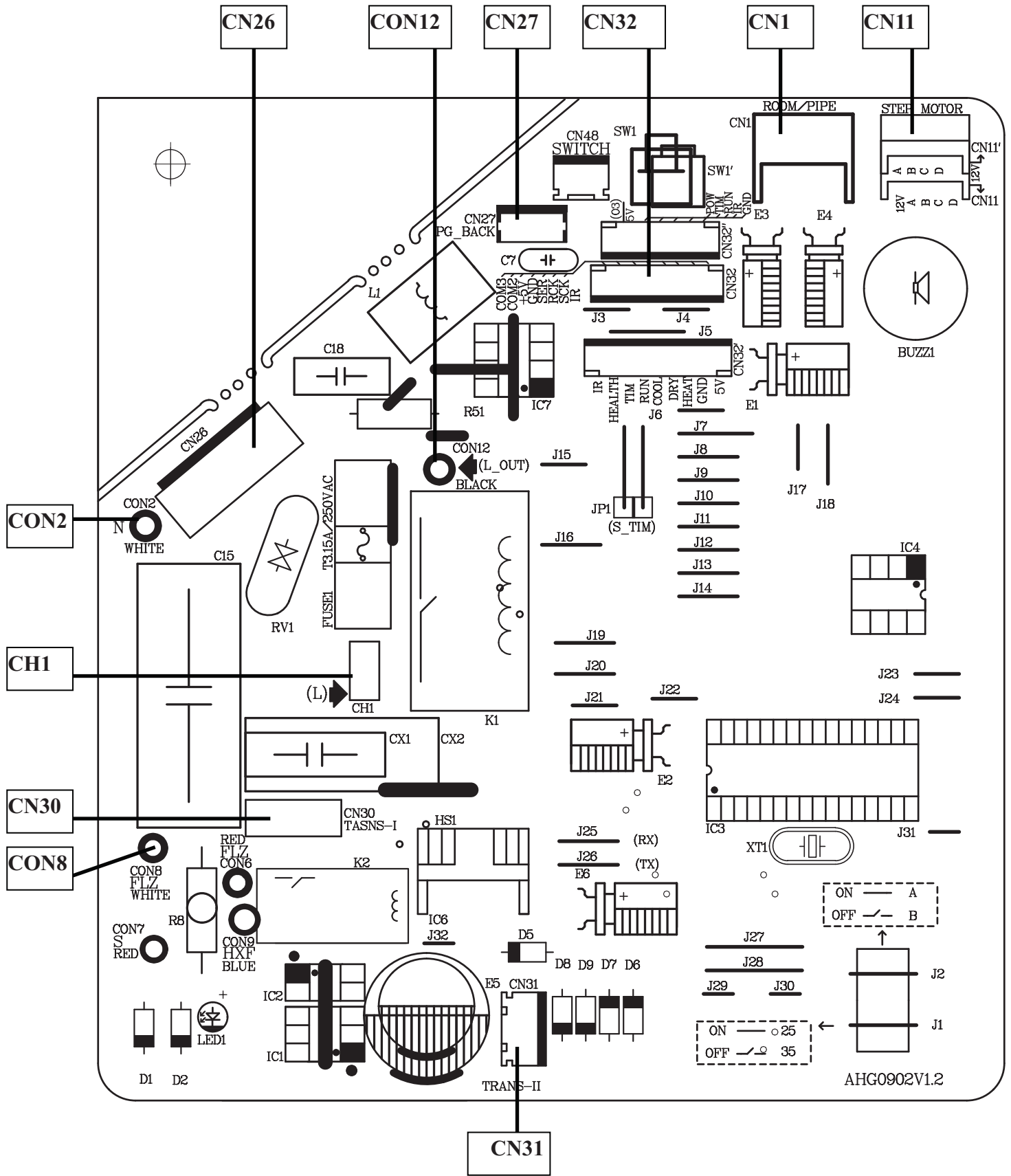

## 4.2 : outdoor unit

### Connectors

#### PCB(1) (Control PCB)

- 1) CN1,CN2 Connector for power N and L
- 2) CN3 Connector for ground
- 3) CN22 Connector for DC POWER 15V and 5V to the module board
- 4) CN16 Connector for electric expansion valves
- 5) CN21 Connector for DC fan motor
- 6) CN10 Connector for four way valve coil
- 7) CN17,CN18,CN19,CN20 Connector for thermistors  
(CN20: outdoor air,CN19: heat exchanger, CN18 :SUCK thermistors ,CN17 :discharge pipe)
- 8) CN23 Connector for communicate between the control board and the module board
- 9) CN25 ,CN8 Connector for the L,N to the module board
- 10) CN4 Connector for communicate between the indoor board and the outdoor board
- 11) CN26 Connector for capacitance anode
- 12) CN24 Connector for capacitance cathode

#### PCB(2) (module PCB)

- CN10 Connector for the DC power 5V and 15V from the control PCB
- CN11 Connector for communicate between the control board and the module board
- P( CN1), N(CN5) Connector for capacitance board
- LI (CN7),LO(CN6) Connector for reactor
- CN2, CN3, CN4 Connector for the U, V, W wire of the compressor

#### **Note:** Other Designations

##### PCB(1) (Control PCB)

- 1) FUSE 1, (25A,250VAC) FUSE 2(1A,250VAC)
- 2)LED 1 keep light representative normal ,if keep flash interval representative trouble Alarm
- 3)RV1,RV2,RV3 Varistor

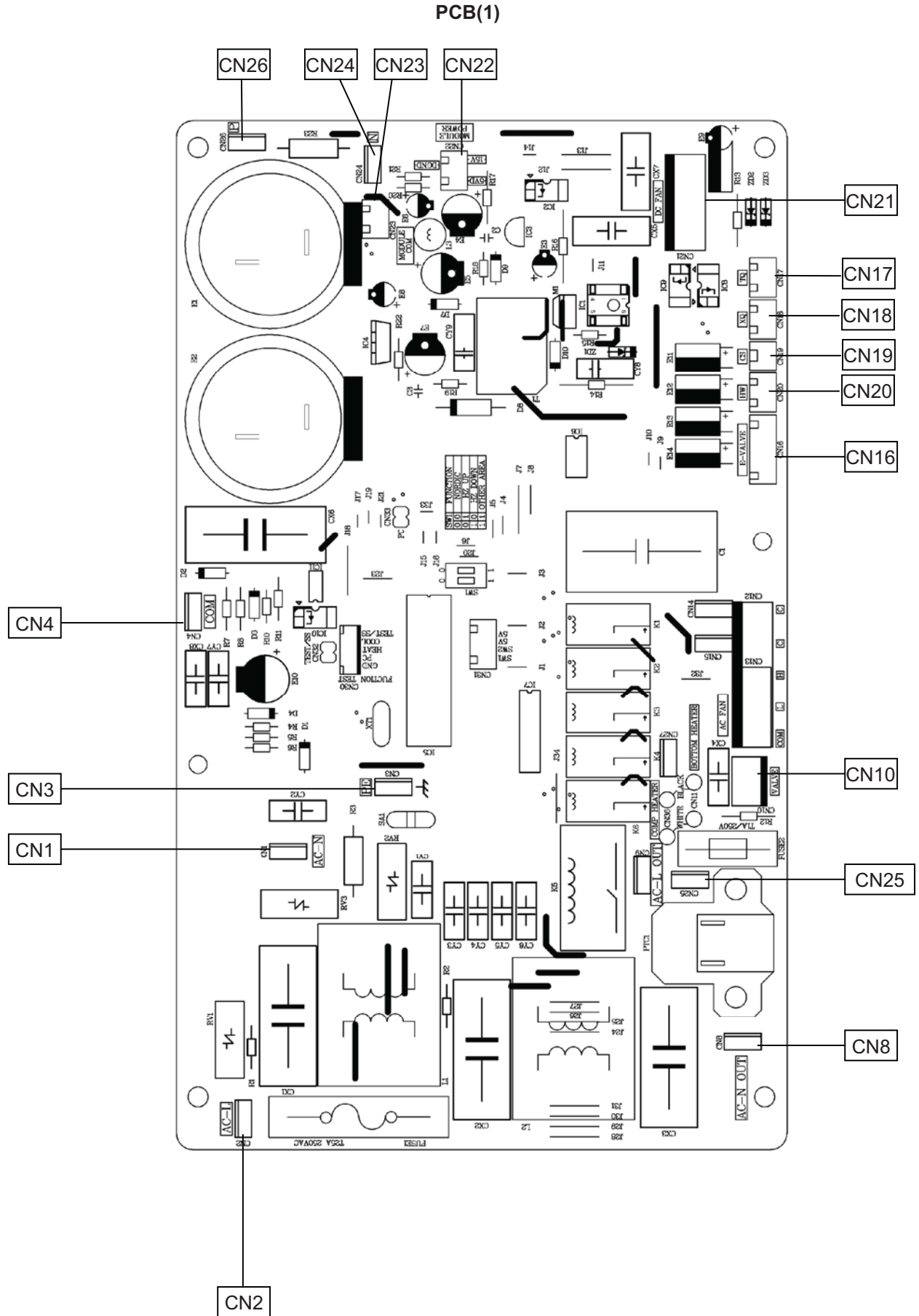

PCB(2)

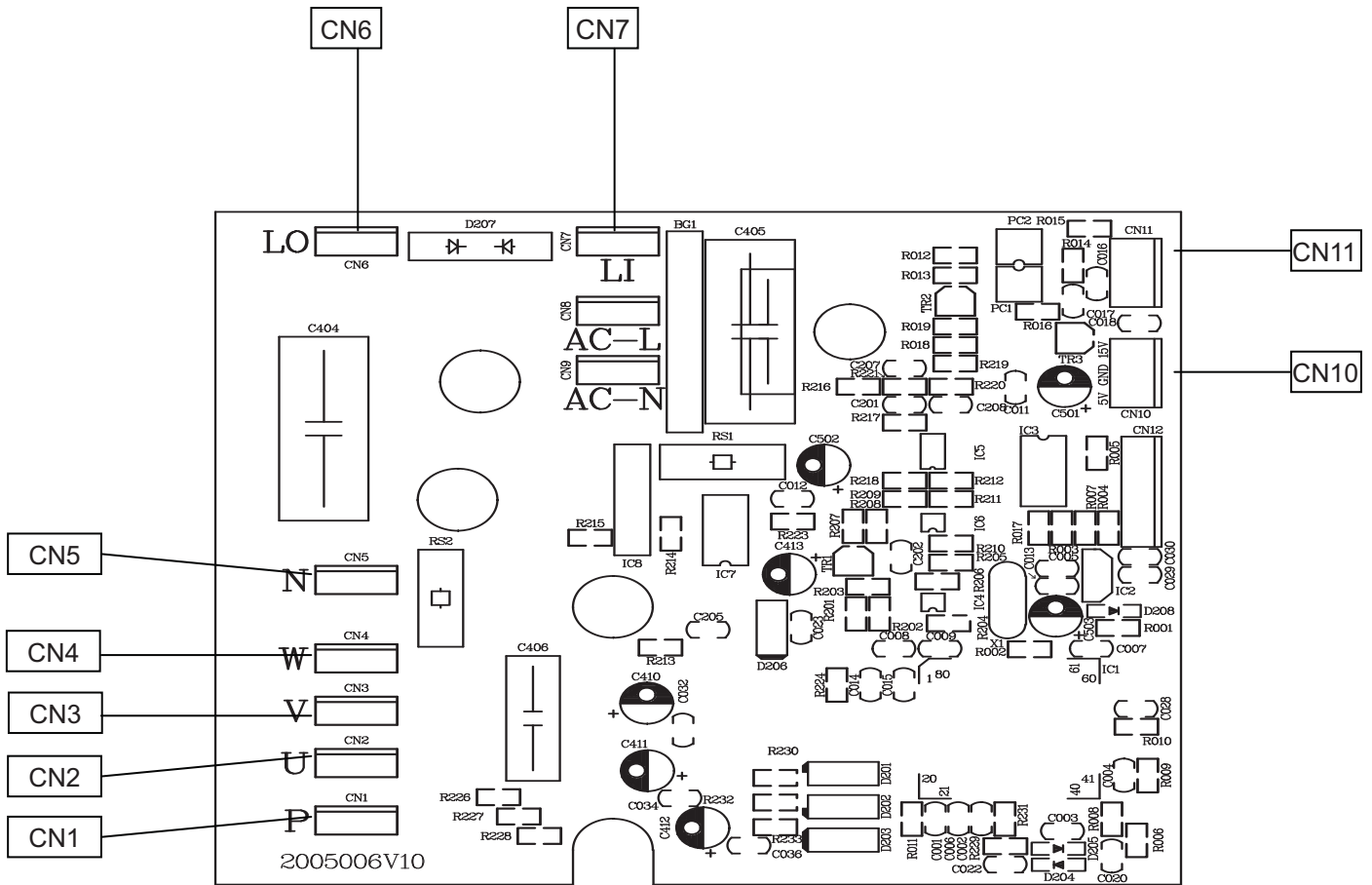

## 5.Functions and Control

### 5.1 Main functions and control specification of indoor unit

This specification use for HSU18VHJ (DB) frequency conversion air condition are manufactured by Haier air condition parent company. "Setting value" (express in parameter) in this specification means is a parameter that is stored in EEPROM. Refer to [EEPROM parameter table].

#### 5.1.1 Temperature Adjusting function

##### 5.1.1.1 Temperature adjusting of different levels.

(DASH operation conditions under different modes)

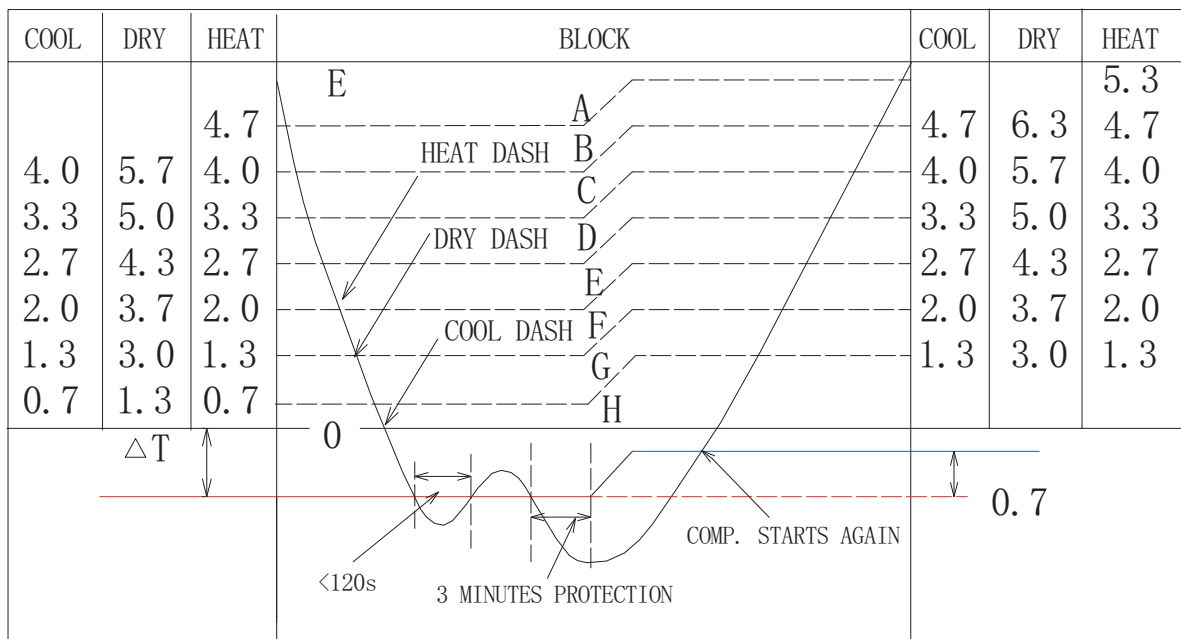

##### 5.1.1.2 Select the wind volume when it is set automatic

When the wind volume is automatic, it can be switched between strong, medium and weak according to the temperature adjusting levels.

Wind volume under the automatic wind volume mode

	Temperature adjusting levels								
	A	B	C	D	E	F	G	H	I
Heating	Strong	Strong	Strong	Strong	Strong	Medium	Weak	Weak	SLO
cooling		Strong	Strong	Strong	Medium	Medium	Weak	Weak	Weak
Moisture removing		Strong	Medium	Medium	Medium	Weak	Weak	SLO	SLO



### 5.1.1.3 Wind volume limit

When the compressor is working and the max setting for indoor fan motor is medium or weak, the upper limit of indicated frequency is as follows:

Frequency control form for wind volume

	Limited frequency variables	Limited frequency
Medium wind volume	FQLIMMD	70Hz
Weak wind volume	FQLIMLO	58Hz
Limited frequency for up/down health wind	FUPHEAL	48Hz

## 5.1.2 Main functions

### 5.1.2.1 Warm boot

When the heat running starts or the frost removing ends and the compressor starts again, in order to avoid cold wind, warm boot wind volume control should be done.

Heat exchange temperature

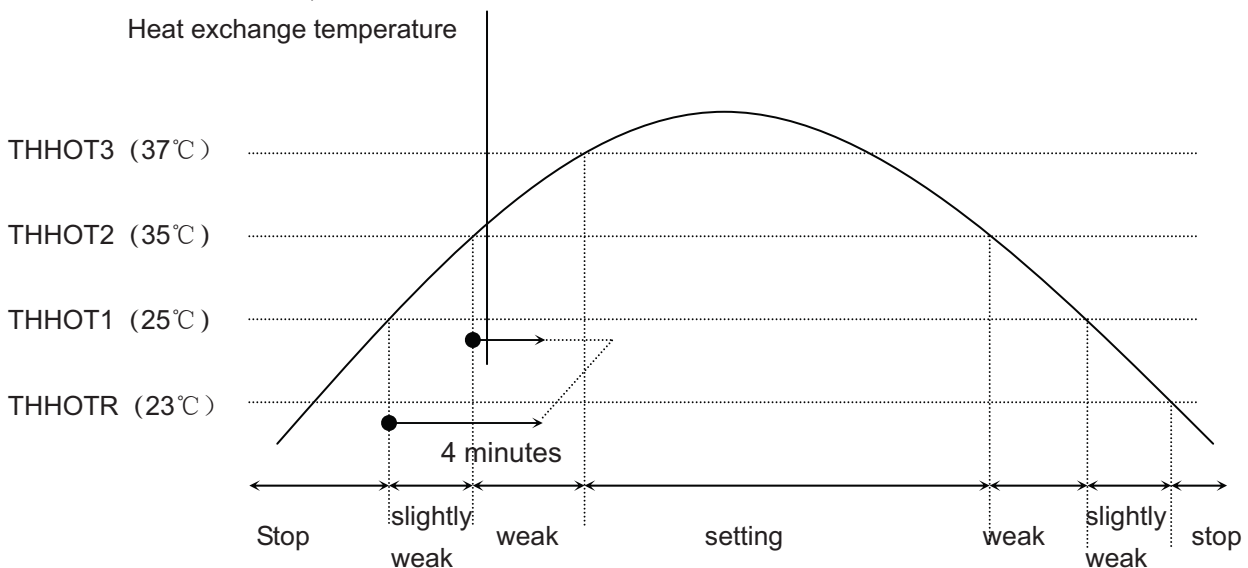

To control the indoor fan motor as shown in the table above according to the heat exchange temperature

The fan motor stops when the heat exchange temperature is below 25°C

The fan motor is working slightly weak when the heat exchange temperature is above 25 °C and below 35°C

The fan motor is working weak when the heat exchange temperature is above 35 °C and below 37°C

The fan motor works as set if the heat exchange temperature remains above 38°C

### 5.1.2.2 When the compressor stops and remains idle for 3 minutes

20 seconds after the compressor stops, the up wind volume is weak (switching to SSLO in silent running mode) and then slightly weak. While the down wind volume is stopped. If the compressor stops when the heat running starts, the wind volume is weak.

### 5.1.2.3 Dehumidification running

Under the dehumidification mode the fan motor stops as the compressor stops.

The operation is weak after 3 minutes' idle mode.

After stand by for 3 minutes, the compressor is on.

The compressor operates as the set wind volume when the wind volume is set to be strong, medium or weak.

The wind volume is decided according to the temperature adjusting when the wind volume is set to be automatic.

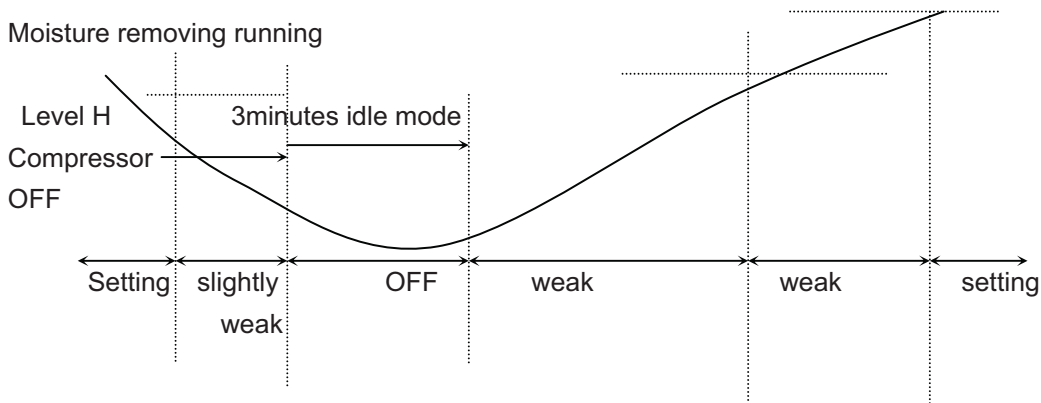

### 5.1.2.4 Automatic running

When the running mode is turned to automation after starting the system, the system will first determine the running mode according to the current room temperature and then will run according to the determined mode.  $T_r$  in the following selection conditions means room temperature,  $T_s$  means setting temperature,  $T_p$  means temperature of indoor coil pipe.

$T_r \geq 23^\circ\text{C}$  Choose Cooling Mode

$T_r < 23^\circ\text{C}$  Choose Heating Mode

After turning to the automation mode, the running mode can be switched between cooling mode, fan mode and heating mode according to the change of the indoor ambient temperature. But the automatic conversion between cooling mode and heating mode must be conducted after 15 minutes.

## 5.1.3 Special functions

### 5.1.3.1 Powerful running

Powerful running for 15 minutes

The running stops or ends the powerful running after 15 minutes

The mode switch ends the powerful running

Enter into the silent mode, normal running mode or timed switching on mode to end the powerful running

When in automatic mode, there are powerful and silent functions for your choice. When the main unit is in cooling mode, it operates with powerful cooling or silent cooling. When the main unit is in heating mode, it operates with powerful heating or silent heating. When the main unit is in wind-sending mode, there are no powerful or silent modes.

There is no powerful mode for wind-sending and moisture removing

#### **Powerful heating:**

Change the set temperature. With temperature adjusting function

The wind volume is the automatic medium

When in frost removing mode, the outdoor unit does not accept the communication signal for powerful running

After 15 minutes of powerful running, the compressor can not be off within 10 minutes

#### **Powerful cooling:**

Change the set temperature. With temperature adjusting function

The wind volume is the automatic strong

After the compressor starts, there will be no low-intense running protection within 3 minutes

### **5.1.3.2 Silent running**

Send the silent running signal to the outdoor unit

Under the Silent hearing mode, The wind volume is SSLO after the compressor is on, The wind volume will be kept SSLO within 20 seconds after the compressor stops and then changes to weak

Under the Silent cooling mode the wind volume is SSLO

There is no silent mode for moisture removing and wind-sending.

### **5.1.3.3 Air cleaning**

If the fan motor starts working after receiving the remote-control order, the aion generator starts working and sends out ions.

The ion generator stops as the fan motor stops.

When the ion generator is OFF and the air cleaning function is on, the fan motor starts running and the ion generator starts working again.

### **5.1.3.4 Timed running**

Set the time duration according to the time difference between the clock for timing and the current clock

In timing mode, the display panel will flash the light at fixed times

<b>Timed OFF</b>	When this function is set, operation modes on the panel display will not change. The timing icon will show and the operation stops when the set time comes.
------------------	---

<b>Timed ON</b>	When this function is on, the panel display will only display a question mark. The unit will operate as the set mode when the time comes.
-----------------	---

<b>Timed ON/OFF</b>	The unit will start operating or stop according to the order of your setting.
---------------------	---

### 5.1.3.5 Sleeping function

a. After setting the sleeping function, the refrigerating mode and dehumidification mode will run as per the following rules:

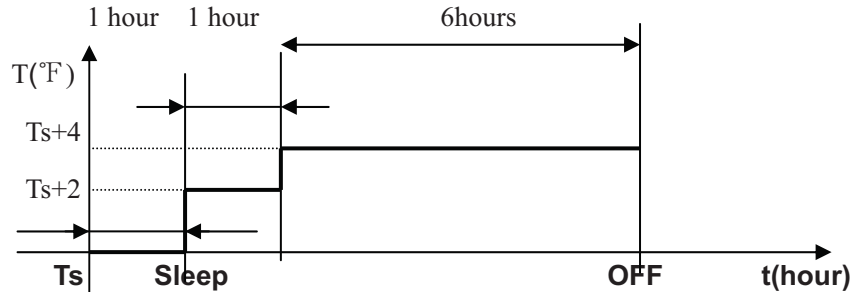

b. After setting the sleeping function, the heating mode will run as per the following rules:

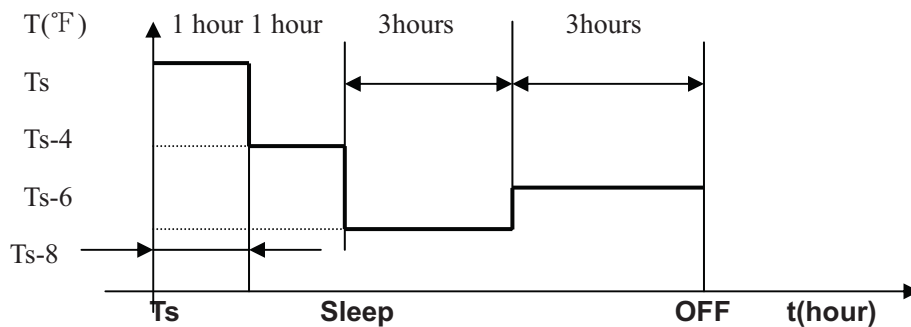

As shown in the above diagram, after running for 1 hour under refrigerating mode and dehumidification mode, the setting temperature will increase about  $2^{\circ}\text{F}$ ; after another 1 hour, it will increase about  $2^{\circ}\text{F}$  again, and after 6 hours, it will cease; after running for 1 hour under heating mode, the setting temperature will decrease about  $4^{\circ}\text{F}$ , after another 1 hour, it will decrease the about  $4^{\circ}\text{F}$  again, and after 3 hours, it will increase about  $2^{\circ}\text{C}$ , and after other 3 hours, it will cease.

### 5.1.3.6 Trial running

The indicated frequency for trial running is 58Hz, wind volume is strong.

The trial running will last for 30 minutes and then the unit will be powered off. The unit will exit the trial running if it receives any remote-control signal during the trial running period.

There is no low-intense running protection.

### 5.1.3.7 Power failure compensation

To enter into the function please press the sleep key 10 times with 4 beeps in 7 seconds

Under the power failure compensation mode, unplug and plug again, the indoor unit will resume original operation

Under the power failure compensation mode, unplug and plug again, the unit will be on OFF state.

Mode, Fan speed, Healthy, Set temperature can be memoried. Swing, Timer, Sleep cannot be

memoried

Press the sleep key for 10 times with 2 beeps in 7 seconds to exit.

---

### **5.1.3.8 Rated Operation**

Rated Cooling:

When receiving the instruction of indoor unit rated operation, the unit will start rated cooling operation.

Rated Heating:

When receiving the instruction of indoor unit rated operation, the unit will start rated heating operation.

---

## 5.2 Main functions and control specification of outdoor unit

Sensor Code Definition: Tai= Indoor Ambient Temperature, Tao=Outdoor Ambient Temperature, Tc1=Indoor Coil, Td= Air Discharge, Te= Outdoor Coil, Ts=Air Intake

### 5.2.1 Outdoor Unit Operation Frequency and Control

#### Compressor Operation Frequency Range

Compressor Operation Frequency Range:

Outdoor Temperature	$\leq 4$	4~18	$\geq 18$
Heating (Hz)	20~110	20~90	20~53
Defrosting (Hz)	80		
Outdoor Temperature	$\leq 23$	23~32	$\geq 32$
Cooling (Hz)	20~50	20~70	20~95

#### Compressor Startup

Regardless of target frequency of indoor unit, each time when compressor is from off to on, it must maintain 60Hz,90Hz for one minute (Frequency will be immediately decreased under the condition that outdoor unit air discharge temperature overheating protection is activated or over current of compressor) then the compressor will operate towards target frequency. This process does not exist in normal operation of unit.

#### Heating

When completing compressor startup operation, it will operate as per frequency of indoor unit. After 2 minutes, compressor operation frequency will be compensated as per relevant conditions.

#### Cooling & Dehumidification:

When completing compressor startup operation, it will operate as per frequency of indoor unit. After 2 minutes, compressor operation frequency will be compensated as per relevant conditions.

#### Compressor Frequency Increase/Decrease Speed

Rapid Frequency Increase/Decrease Speed 1 -----1Hz/s

Slow Frequency Increase/Decrease Speed 2 -----1Hz/10s

## 5.2.2 Outdoor fan control

**Compressor startup within 3min ,outdoor fan speed control as follows:**

Outdoor Temperature	<10	10~25	≥25
Cooling/ Dehumidification	1	3	7
Heating	5	3	2

**After compressor runs 3min ,outdoor fan speed control as follows:**

Cooling/ Dehumidification:

Compressor Operation Frequency (Hz)		<25	25~45	≥45
Tao (°C)	32 ~38	3	4	7
	23~32	1	2	5
	<23			
	≥38	7		

Heating:

Compressor Operation Frequency (Hz)		<25	25~45	≥45
Tao (°C)	≤4	3	4	7
	4~18	2	4	7
	≥18	1		

### Compressor shutdown and outdoor fan residual heat blow process

When compressor shuts down in cooling mode, outdoor fan automatically jumps to low speed and blows residual heat for 30s and stop.

## 5.2.3 Four-way Valve Control

Defrosting Four-way Valve Control, (please see defrosting process for details)

Time sequence of the defrosting operation is as follows:

Four-way Valve Work Status in Other Modes:

In heating mode, four-way valve is on. If compressor is off or is switched to non-heating mode, four-way valve ensures that it is off at least 2 minutes after compressor shuts down.

## 5.2.4 Outdoor Defrosting Control

### Defrosting Mode Entry Conditions

The unit will enter defrosting mode when compressor starts up and operates for 10 minutes continuously in heating mode or after compressor runs for an accumulated time of 45 minutes (Upon completion of defrosting or when switched to cooling mode, compressor accumulated operation time will be cleared) and when 2 minutes' continuous checking by defrosting sensor TE (check frosting condition of outdoor unit heat exchanger) and outdoor ambient temperature sensor TA meets the following conditions:

$$TE \leq C \times TA - \alpha$$

Among which:  $C: TA < 0^\circ\text{C}$ ,  $C=0.8$

$$TA \geq 0^\circ\text{C}, C=0.6$$

For area prone to frost, the value is set at 6 when unit leaves the factory.

Defrosting entry temperature control  $-15^\circ\text{C} \leq C \times TA - \alpha \leq -5^\circ\text{C}$

---

### Defrosting Time Interval

time interval between two defrosting cycles is 45 minutes.

### Defrosting Operation

When defrosting begins, compressor will stop for one minute, external fan is running and 50s later, four-way valve will be off.

When compressor starts, external fan will be off, compressor will run at 58Hz for 60s then move on to target frequency of 88Hz.

During defrosting, compressor current and air discharge overheat protection features are effective. During defrosting, if compressor shuts down due to activation of protection feature or due to malfunction, it will resume after 3 minutes. In the unit is still within defrosting cycle, it will resume defrosting and startup of compressor will be based on the rule for defrosting startup. (The unit will exit defrosting mode and handle fault in the event of 3 consecutive restart failures.)

On entering defrosting, it must guarantee that compressor will operate for a minimum of 2 minutes in defrosting mode before exit.

---

### Defrosting Exit Condition

When one of the following conditions is met, defrosting operation will be switched to heating operation.

- (1) : Temperature of outdoor heat exchanger exceeds  $7^\circ\text{C}$  for 80s continuously
  - (2) : Temperature of outdoor heat exchanger exceeds  $12^\circ\text{C}$  for 5s continuously
  - (3) : Defrosting operation continues for 11 minutes.
- 

### When defrosting exit conditions are met, the unit will operate as follows

Compressor stops and external fan starts, 50s later, four-way valve will be on, 60s later, compressor will operate as per startup process.

---

## 5.2.5 PTC Output Control

When outdoor unit is energized, PTC output value is 0, 10s later, output value is 1.

When compressor stops for 10 minutes continuously, PTC output value is 0.

On receiving compressor startup instruction, initial PTC output is 1, and compressor startup will be performed 5s later.

---



## 5.2.6 System Protection Function

### 5.2.6.1 3 minutes stand-by time

Time interval between compressor shutdown and restart is set at 3 minutes to ensure that compressor will only restart after 3-minute shutdown and initial energization valves are turned on to adequate opening position after being fully turned off.

### 5.2.6.2 TD High Temperature Protections

As long as unit is on, the TD air discharge overheat protection feature will be activated, yet air discharge sensor fault must be alarmed 4 minutes after compressor starts.

TD (°C)

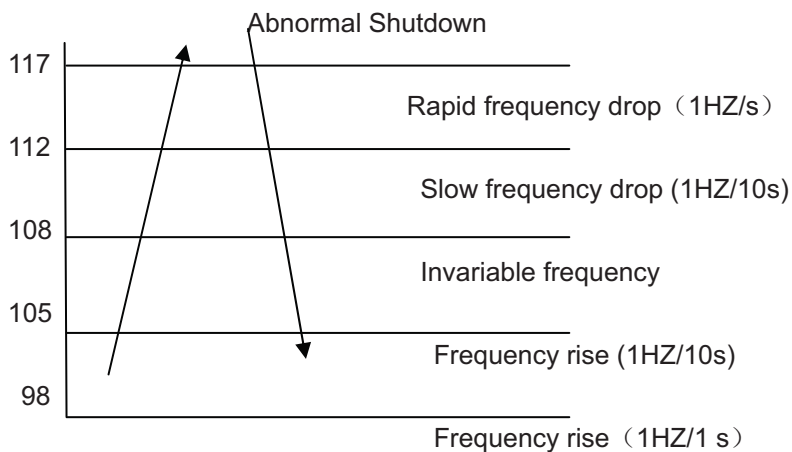

When TD > 117°C for 20s continuously, air discharge overheat protection will be activated and fault will be reported to indoor unit.

It will not continue in other conditions.

### 5.2.6.3 Indoor Heat Exchanger Anti-freeze Protection

Anti-freeze during cooling

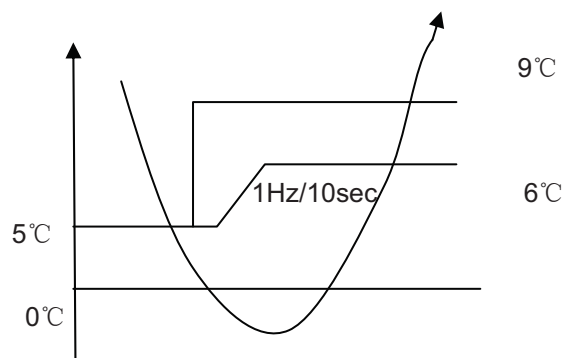

When TC < 5°C, compressor frequency will drop at a speed of 1HZ/10s

When TC starts to rise, and 6 ≤ TC ≤ 9°C, compressor frequency will remain unchanged.

When 9 < TC < 11°C, frequency will rise normal.

If TC ≤ 0°C, for 2 consecutive minutes, compressor will shutdown and outdoor fault lamp blinks. Fault will not be reported to indoor unit.

When compressor shuts down for more than 3 minutes, and when TC > 9°C, compressor will restart.

#### 5.2.6.4 Outdoor Temperature Limit

Cooling: When outdoor temperature is lower than 23°C, cooling operation will start, compressor frequency is limited to less than 50 HZ, outdoor wind speed is forced at level 1.

Heating: When outdoor temperature is higher than 18°C, heating operation will start, compressor frequency is limited to less than 53 HZ, outdoor wind speed is forced at level 1.

---

#### 5.2.6.5 Special Features

1. Forced Cooling: When receiving indoor forced cooling signal, cooling operation will start in a frequency signaled by indoor unit. Only air discharge temperature and over current protection features are effective and other protection features are invalid.

2. Rated, Middle and Minimum Capacity Operation: When receiving indoor, rated, middle and minimum capacity operation signal, outdoor unit will operate as per wind speed and frequency set by EEPROM and all the protection features are effective.

---

#### 5.2.6.6 Fault Display and Treatment

In case outdoor unit faults, the alarm indicator lamp will blink and blink frequency is 1HZ, Time interval between blink cycles is 3s.

Alarm indicator lamp is off when there is no fault.

## 5.3 Function of Main Thermistor

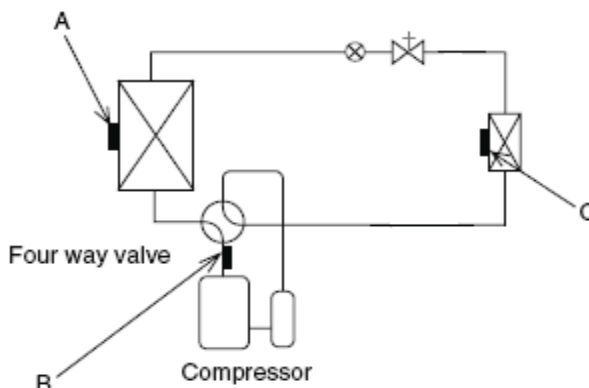

**Note:** A:Outdoor suction temperature sensor

B: Exhaust temperature sensor

C: Indoor heat-exchange sensor

### Outdoor Suction Temperature Sensor

The outdoor heat exchanger thermistor is used for controlling target discharge temperature. The system sets a target discharge temperature according to the outdoor and indoor heat exchanger temperature, and controls the electronic expansion valve opening so that the target discharge temperature can be obtained.

### Exhaust Temperature Sensor

The discharge pipe thermistor is used for controlling temperature of the discharge pipe. If the temperature of discharge pipe (used in place of the inner temperature of the compressor) rises abnormally, the operating frequency drops or the operation halts.

### Indoor heat-exchange sensor

1.The indoor heat exchanger thermistor is used for controlling target discharge temperature. The system sets a target discharge temperature according to the outdoor and indoor heat exchanger temperature, and controls the electronic expansion valve opening so that the target discharge temperature can be obtained.

2.The indoor heat exchanger thermistor is used for preventing freezing.During the cooling operation, if the temperature drops abnormally, the operating frequency becomes lower, then the operation halts.

3.The indoor heat exchanger thermistor is used for anti-icing control.During the cooling operation, if the heat exchanger temperature in the room where operation is halted becomes  $-1^{\circ}\text{C}$ , it is assumed as icing.

## 5.4 Value of Thermistor

### 5.4.1 indoor Unit

#### Room sensor

$R_{25^{\circ}\text{C}}=23\text{K}\Omega\pm 3.5\%$

$B_{25^{\circ}\text{C}/50^{\circ}\text{C}}=4200\text{K}\pm 3\%$

Temp.( $^{\circ}\text{C}$ )	Max.( $\text{K}\Omega$ )	Normal( $\text{K}\Omega$ )	Min.( $\text{K}\Omega$ )	Tolerance( $^{\circ}\text{C}$ )	
-30	568.8372	501.0746	440.8435	-1.97	1.75
-29	530.9600	468.6491	413.1441	-1.95	1.74
-28	495.8488	438.5314	387.3645	-1.93	1.72
-27	463.2850	410.5433	363.3602	-1.91	1.71
-26	433.0683	384.5212	340.9980	-1.90	1.70
-25	405.0156	360.3153	320.1558	-1.88	1.69
-24	378.9588	337.7879	300.7211	-1.86	1.67
-23	354.7440	316.8126	282.5905	-1.84	1.66
-22	332.2300	297.2732	265.6686	-1.82	1.64
-21	311.2873	279.0627	249.8676	-1.80	1.63
-20	291.7969	262.0831	235.1067	-1.78	1.62
-19	273.6494	246.2437	221.3111	-1.76	1.60
-18	256.7445	231.4612	208.4122	-1.74	1.59
-17	240.9897	217.6590	196.3462	-1.72	1.57
-16	226.3000	204.7662	185.0545	-1.70	1.56
-15	212.5973	192.7176	174.4829	-1.68	1.54
-14	199.8093	181.4531	164.5813	-1.66	1.53
-13	187.8698	170.9169	155.3033	-1.64	1.51
-12	176.7176	161.0578	146.6059	-1.62	1.49
-11	166.2961	151.8284	138.4495	-1.60	1.48
-10	156.5532	143.1847	130.7973	-1.58	1.46
-9	147.4409	135.0863	123.6153	-1.56	1.44
-8	138.9148	127.4956	116.8717	-1.53	1.43
-7	130.9337	120.3778	110.5374	-1.51	1.41
-6	123.4597	113.7009	104.5852	-1.49	1.39
-5	116.4577	107.4349	98.9897	-1.47	1.38
-4	109.8953	101.5523	93.7278	-1.45	1.36
-3	103.7422	96.0274	88.7774	-1.43	1.34
-2	97.9708	90.8365	84.1185	-1.40	1.32
-1	92.5551	85.9574	79.7322	-1.38	1.30
0	87.4712	81.3697	75.6011	-1.36	1.29
1	82.6970	77.0544	71.7088	-1.34	1.27
2	78.2118	72.9937	68.0402	-1.31	1.25
3	73.9966	69.1712	64.5813	-1.29	1.23
4	70.0335	65.5716	61.3188	-1.27	1.21
5	66.3062	62.1807	58.2405	-1.24	1.19

6	62.7992	58.9853	55.3351	-1.22	1.17
7	59.4984	55.9729	52.5917	-1.20	1.15
8	56.3905	53.1320	50.0006	-1.17	1.13
9	53.4631	50.4521	47.5523	-1.15	1.11
10	50.7048	47.9230	45.2384	-1.13	1.09
11	48.1049	45.5355	43.0505	-1.10	1.07
12	45.6534	43.2808	40.9813	-1.08	1.04
13	43.3410	41.1509	39.0236	-1.05	1.02
14	41.1592	39.1381	37.1708	-1.03	1.00
15	39.0998	37.2355	35.4167	-1.00	0.98
16	37.1553	35.4363	33.7555	-0.98	0.96
17	35.3186	33.7344	32.1818	-0.95	0.94
18	33.5833	32.1240	30.6905	-0.93	0.91
19	31.9432	30.5997	29.2769	-0.90	0.89
20	30.3925	29.1565	27.9365	-0.88	0.87
21	28.9259	27.7895	26.6651	-0.85	0.84
22	27.5383	26.4944	25.4589	-0.83	0.82
23	26.2252	25.2670	24.3140	-0.80	0.80
24	24.9822	24.1034	23.2271	-0.78	0.77
25	23.8050	23.0000	22.1950	-0.78	0.77
26	22.7500	21.9499	21.1520	-0.78	0.78
27	21.7477	20.9536	20.1638	-0.82	0.81
28	20.7951	20.0081	19.2272	-0.86	0.85
29	19.8895	19.1104	18.3394	-0.89	0.88
30	19.0285	18.2581	17.4974	-0.93	0.92
31	18.2094	17.4484	16.6988	-0.97	0.95
32	17.4302	16.6792	15.9410	-1.00	0.99
33	16.6885	15.9480	15.2217	-1.04	1.02
34	15.9825	15.2530	14.5389	-1.08	1.06
35	15.3103	14.5920	13.8903	-1.12	1.09
36	14.6700	13.9632	13.2743	-1.16	1.13
37	14.0599	13.3650	12.6889	-1.20	1.16
38	13.4786	12.7957	12.1325	-1.23	1.20
39	12.9244	12.2537	11.6035	-1.27	1.24
40	12.3960	11.7375	11.1004	-1.31	1.27
41	11.8921	11.2459	10.6218	-1.35	1.31
42	11.4113	10.7775	10.1665	-1.39	1.34
43	10.9526	10.3311	9.7330	-1.43	1.38
44	10.5147	9.9056	9.3204	-1.48	1.42
45	10.0967	9.4999	8.9275	-1.52	1.45
46	9.6976	9.1130	8.5532	-1.56	1.49
47	9.3163	8.7439	8.1965	-1.60	1.53
48	8.9521	8.3916	7.8566	-1.64	1.57
49	8.6040	8.0554	7.5327	-1.68	1.60

50	8.2713	7.7345	7.2237	-1.73	1.64
51	7.9531	7.4280	6.9291	-1.77	1.68
52	7.6489	7.1353	6.6480	-1.81	1.72
53	7.3580	6.8556	6.3797	-1.85	1.76
54	7.0796	6.5884	6.1237	-1.90	1.79
55	6.8131	6.3329	5.8793	-1.94	1.83
56	6.5581	6.0887	5.6459	-1.99	1.87
57	6.3140	5.8552	5.4230	-2.03	1.91
58	6.0802	5.6318	5.2100	-2.07	1.95
59	5.8563	5.4181	5.0065	-2.12	1.99
60	5.6417	5.2136	4.8120	-2.16	2.03
61	5.4361	5.0178	4.6260	-2.21	2.07
62	5.2391	4.8304	4.4481	-2.25	2.11
63	5.0502	4.6510	4.2780	-2.30	2.15
64	4.8691	4.4791	4.1153	-2.35	2.19
65	4.6954	4.3145	3.9596	-2.39	2.23
66	4.5287	4.1567	3.8105	-2.44	2.27
67	4.3689	4.0055	3.6678	-2.49	2.31
68	4.2154	3.8605	3.5312	-2.53	2.35
69	4.0682	3.7216	3.4004	-2.58	2.39
70	3.9268	3.5883	3.2750	-2.63	2.43
71	3.7910	3.4605	3.1549	-2.68	2.48
72	3.6606	3.3378	3.0398	-2.73	2.52
73	3.5353	3.2201	2.9294	-2.77	2.56
74	3.4150	3.1072	2.8237	-2.82	2.60
75	3.2993	2.9987	2.7222	-2.87	2.64
76	3.1881	2.8946	2.6249	-2.92	2.68
77	3.0812	2.7946	2.5316	-2.97	2.73
78	2.9785	2.6986	2.4420	-3.02	2.77
79	2.8796	2.6063	2.3560	-3.07	2.81
80	2.7845	2.5176	2.2735	-3.12	2.86
81	2.6931	2.4324	2.1943	-3.17	2.90
82	2.6050	2.3505	2.1182	-3.22	2.94
83	2.5203	2.2717	2.0451	-3.28	2.99
84	2.4388	2.1960	1.9749	-3.33	3.03
85	2.3602	2.1231	1.9075	-3.38	3.07
86	2.2846	2.0530	1.8426	-3.43	3.12
87	2.2118	1.9856	1.7803	-3.48	3.16
88	2.1416	1.9207	1.7204	-3.54	3.20
89	2.0740	1.8582	1.6628	-3.59	3.25
90	2.0089	1.7981	1.6074	-3.64	3.29
91	1.9461	1.7402	1.5541	-3.70	3.34

92	1.8856	1.6844	1.5028	-3.75	3.38
93	1.8272	1.6307	1.4535	-3.80	3.43
94	1.7709	1.5789	1.4060	-3.86	3.47
95	1.7166	1.5291	1.3603	-3.91	3.52
96	1.6643	1.4810	1.3163	-3.97	3.56
97	1.6138	1.4347	1.2739	-4.02	3.61
98	1.5650	1.3900	1.2331	-4.08	3.66
99	1.5180	1.3470	1.1937	-4.13	3.70
100	1.4726	1.3054	1.1559	-4.19	3.75
101	1.4287	1.2654	1.1194	-4.24	3.80
102	1.3864	1.2268	1.0842	-4.30	3.84
103	1.3455	1.1895	1.0503	-4.36	3.89
104	1.3060	1.1535	1.0176	-4.42	3.94
105	1.2679	1.1188	0.9860	-4.47	3.98
106	1.2310	1.0853	0.9556	-4.53	4.03
107	1.1954	1.0529	0.9263	-4.59	4.08
108	1.1610	1.0217	0.8980	-4.65	4.13
109	1.1277	0.9915	0.8707	-4.70	4.17
110	1.0955	0.9624	0.8443	-4.76	4.22
111	1.0644	0.9342	0.8189	-4.82	4.27
112	1.0344	0.9070	0.7943	-4.88	4.32
113	1.0053	0.8807	0.7706	-4.94	4.37
114	0.9771	0.8553	0.7478	-5.00	4.41
115	0.9499	0.8307	0.7256	-5.06	4.46
116	0.9235	0.8070	0.7043	-5.12	4.51
117	0.8980	0.7840	0.6837	-5.18	4.56
118	0.8734	0.7618	0.6637	-5.24	4.61
119	0.8495	0.7404	0.6445	-5.30	4.66
120	0.8263	0.7196	0.6258	-5.36	4.71

## Pipe Sensor

R25°C=10KΩ ± 3%

B25°C/50°C=3700K ± 3%

Temp.((°C))	Max.(KΩ)	Normal(KΩ)	Min.(KΩ)	Tolerance(°C)	
-30	165.2170	147.9497	132.3678	-1.94	1.75
-29	155.5754	139.5600	125.0806	-1.93	1.74
-28	146.5609	131.7022	118.2434	-1.91	1.73
-27	138.1285	124.3392	111.8256	-1.89	1.71
-26	130.2371	117.4366	105.7989	-1.87	1.70
-25	122.8484	110.9627	100.1367	-1.85	1.69
-24	115.9272	104.8882	94.8149	-1.83	1.67
-23	109.4410	99.1858	89.8106	-1.81	1.66
-22	103.3598	93.8305	85.1031	-1.80	1.64

-21	97.6556	88.7989	80.6728	-1.78	1.63
-20	92.3028	84.0695	76.5017	-1.76	1.62
-19	87.2775	79.6222	72.5729	-1.74	1.60
-18	82.5577	75.4384	68.8710	-1.72	1.59
-17	78.1230	71.5010	65.3815	-1.70	1.57
-16	73.9543	67.7939	62.0907	-1.68	1.55
-15	70.0342	64.3023	58.9863	-1.66	1.54
-14	66.3463	61.0123	56.0565	-1.64	1.52
-13	62.8755	57.9110	53.2905	-1.62	1.51
-12	59.6076	54.9866	50.6781	-1.60	1.49
-11	56.5296	52.2278	48.2099	-1.58	1.47
-10	53.6294	49.6244	45.8771	-1.56	1.46
-9	50.8956	47.1666	43.6714	-1.54	1.44
-8	48.3178	44.8454	41.5851	-1.51	1.42
-7	45.8860	42.6525	39.6112	-1.49	1.40
-6	43.5912	40.5800	37.7429	-1.47	1.39
-5	41.4249	38.6207	35.9739	-1.45	1.37
-4	39.3792	36.7676	34.2983	-1.43	1.35
-3	37.4465	35.0144	32.7108	-1.41	1.33
-2	35.6202	33.3552	31.2062	-1.38	1.31
-1	33.8936	31.7844	29.7796	-1.36	1.29
0	32.2608	30.2968	28.4267	-1.34	1.28
1	30.7162	28.8875	27.1431	-1.32	1.26
2	29.2545	27.5519	25.9250	-1.29	1.24
3	27.8708	26.2858	24.7686	-1.27	1.22
4	26.5605	25.0851	23.6704	-1.25	1.20
5	25.3193	23.9462	22.6273	-1.23	1.18
6	24.1432	22.8656	21.6361	-1.20	1.16
7	23.0284	21.8398	20.6939	-1.18	1.14
8	21.9714	20.8659	19.7982	-1.15	1.12
9	20.9688	19.9409	18.9463	-1.13	1.09
10	20.0176	19.0621	18.1358	-1.11	1.07
11	19.1149	18.2270	17.3646	-1.08	1.05
12	18.2580	17.4331	16.6305	-1.06	1.03
13	17.4442	16.6782	15.9315	-1.03	1.01
14	16.6711	15.9601	15.2657	-1.01	0.99
15	15.9366	15.2770	14.6315	-0.98	0.96
16	15.2385	14.6268	14.0271	-0.96	0.94
17	14.5748	14.0079	13.4510	-0.93	0.92
18	13.9436	13.4185	12.9017	-0.91	0.90
19	13.3431	12.8572	12.3778	-0.88	0.87
20	12.7718	12.3223	11.8780	-0.86	0.85
21	12.2280	11.8126	11.4011	-0.83	0.83
22	11.7102	11.3267	10.9459	-0.81	0.80



23	11.2172	10.8634	10.5114	-0.78	0.78
24	10.7475	10.4216	10.0964	-0.75	0.75
25	10.3000	10.0000	9.7000	-0.75	0.75
26	9.8975	9.5974	9.2980	-0.76	0.76
27	9.5129	9.2132	8.9148	-0.80	0.80
28	9.1454	8.8465	8.5496	-0.84	0.83
29	8.7942	8.4964	8.2013	-0.87	0.86
30	8.4583	8.1621	7.8691	-0.91	0.90
31	8.1371	7.8428	7.5522	-0.95	0.93
32	7.8299	7.5377	7.2498	-0.98	0.97
33	7.5359	7.2461	6.9611	-1.02	1.00
34	7.2546	6.9673	6.6854	-1.06	1.04
35	6.9852	6.7008	6.4222	-1.10	1.07
36	6.7273	6.4459	6.1707	-1.13	1.11
37	6.4803	6.2021	5.9304	-1.17	1.14
38	6.2437	5.9687	5.7007	-1.21	1.18
39	6.0170	5.7454	5.4812	-1.25	1.22
40	5.7997	5.5316	5.2712	-1.29	1.25
41	5.5914	5.3269	5.0704	-1.33	1.29
42	5.3916	5.1308	4.8783	-1.37	1.33
43	5.2001	4.9430	4.6944	-1.41	1.36
44	5.0163	4.7630	4.5185	-1.45	1.40
45	4.8400	4.5905	4.3500	-1.49	1.44
46	4.6708	4.4252	4.1887	-1.53	1.47
47	4.5083	4.2666	4.0342	-1.57	1.51
48	4.3524	4.1145	3.8862	-1.61	1.55
49	4.2026	3.9686	3.7443	-1.65	1.59
50	4.0588	3.8287	3.6084	-1.70	1.62
51	3.9206	3.6943	3.4780	-1.74	1.66
52	3.7878	3.5654	3.3531	-1.78	1.70
53	3.6601	3.4416	3.2332	-1.82	1.74
54	3.5374	3.3227	3.1183	-1.87	1.78
55	3.4195	3.2085	3.0079	-1.91	1.82
56	3.3060	3.0989	2.9021	-1.95	1.85
57	3.1969	2.9935	2.8005	-2.00	1.89
58	3.0919	2.8922	2.7029	-2.04	1.93
59	2.9909	2.7948	2.6092	-2.08	1.97
60	2.8936	2.7012	2.5193	-2.13	2.01
61	2.8000	2.6112	2.4328	-2.17	2.05
62	2.7099	2.5246	2.3498	-2.22	2.09
63	2.6232	2.4413	2.2700	-2.26	2.13
64	2.5396	2.3611	2.1932	-2.31	2.17
65	2.4591	2.2840	2.1195	-2.36	2.21
66	2.3815	2.2098	2.0486	-2.40	2.25

67	2.3068	2.1383	1.9803	-2.45	2.29
68	2.2347	2.0695	1.9147	-2.49	2.34
69	2.1652	2.0032	1.8516	-2.54	2.38
70	2.0983	1.9393	1.7908	-2.59	2.42
71	2.0337	1.8778	1.7324	-2.63	2.46
72	1.9714	1.8186	1.6761	-2.68	2.50
73	1.9113	1.7614	1.6219	-2.73	2.54
74	1.8533	1.7064	1.5697	-2.78	2.58
75	1.7974	1.6533	1.5194	-2.83	2.63
76	1.7434	1.6021	1.4710	-2.88	2.67
77	1.6913	1.5528	1.4243	-2.92	2.71
78	1.6409	1.5051	1.3794	-2.97	2.75
79	1.5923	1.4592	1.3360	-3.02	2.80
80	1.5454	1.4149	1.2942	-3.07	2.84
81	1.5000	1.3721	1.2540	-3.12	2.88
82	1.4562	1.3308	1.2151	-3.17	2.93
83	1.4139	1.2910	1.1776	-3.22	2.97
84	1.3730	1.2525	1.1415	-3.27	3.01
85	1.3335	1.2153	1.1066	-3.32	3.06
86	1.2953	1.1794	1.0730	-3.38	3.10
87	1.2583	1.1448	1.0405	-3.43	3.15
88	1.2226	1.1113	1.0092	-3.48	3.19
89	1.1880	1.0789	0.9789	-3.53	3.24
90	1.1546	1.0476	0.9497	-3.58	3.28
91	1.1223	1.0174	0.9215	-3.64	3.33
92	1.0910	0.9882	0.8942	-3.69	3.37
93	1.0607	0.9599	0.8679	-3.74	3.42
94	1.0314	0.9326	0.8424	-3.80	3.46
95	1.0030	0.9061	0.8179	-3.85	3.51
96	0.9756	0.8806	0.7941	-3.90	3.55
97	0.9490	0.8558	0.7711	-3.96	3.60
98	0.9232	0.8319	0.7489	-4.01	3.64
99	0.8983	0.8088	0.7275	-4.07	3.69
100	0.8741	0.7863	0.7067	-4.12	3.74
101	0.8507	0.7646	0.6867	-4.18	3.78
102	0.8281	0.7436	0.6672	-4.23	3.83
103	0.8061	0.7233	0.6484	-4.29	3.88
104	0.7848	0.7036	0.6303	-4.34	3.92
105	0.7641	0.6845	0.6127	-4.40	3.97
106	0.7441	0.6661	0.5957	-4.46	4.02
107	0.7247	0.6482	0.5792	-4.51	4.07
108	0.7059	0.6308	0.5632	-4.57	4.12
109	0.6877	0.6140	0.5478	-4.63	4.16
110	0.6700	0.5977	0.5328	-4.69	4.21

111	0.6528	0.5820	0.5183	-4.74	4.26
112	0.6361	0.5667	0.5043	-4.80	4.31
113	0.6200	0.5518	0.4907	-4.86	4.36
114	0.6043	0.5374	0.4775	-4.92	4.41
115	0.5891	0.5235	0.4648	-4.98	4.45
116	0.5743	0.5100	0.4524	-5.04	4.50
117	0.5600	0.4968	0.4404	-5.10	4.55
118	0.5460	0.4841	0.4288	-5.16	4.60
119	0.5325	0.4717	0.4175	-5.22	4.65
120	0.5194	0.4597	0.4066	-5.28	4.70

## 5.4.2 Outdoor Unit

### Ambient Sensor, Suction Sensor, Defrosting Sensor

R25°C=10K Ω ±3%

B25°C/50°C=3700K ±3%

Temp.(°C)	Max.(KΩ)	Normal(KΩ)	Min.(KΩ)	Tolerance(°C)	
-30	165.2170	147.9497	132.3678	-1.94	1.75
-29	155.5754	139.5600	125.0806	-1.93	1.74
-28	146.5609	131.7022	118.2434	-1.91	1.73
-27	138.1285	124.3392	111.8256	-1.89	1.71
-26	130.2371	117.4366	105.7989	-1.87	1.70
-25	122.8484	110.9627	100.1367	-1.85	1.69
-24	115.9272	104.8882	94.8149	-1.83	1.67
-23	109.4410	99.1858	89.8106	-1.81	1.66
-22	103.3598	93.8305	85.1031	-1.80	1.64
-21	97.6556	88.7989	80.6728	-1.78	1.63
-20	92.3028	84.0695	76.5017	-1.76	1.62
-19	87.2775	79.6222	72.5729	-1.74	1.60
-18	82.5577	75.4384	68.8710	-1.72	1.59
-17	78.1230	71.5010	65.3815	-1.70	1.57
-16	73.9543	67.7939	62.0907	-1.68	1.55
-15	70.0342	64.3023	58.9863	-1.66	1.54
-14	66.3463	61.0123	56.0565	-1.64	1.52
-13	62.8755	57.9110	53.2905	-1.62	1.51
-12	59.6076	54.9866	50.6781	-1.60	1.49
-11	56.5296	52.2278	48.2099	-1.58	1.47
-10	53.6294	49.6244	45.8771	-1.56	1.46
-9	50.8956	47.1666	43.6714	-1.54	1.44
-8	48.3178	44.8454	41.5851	-1.51	1.42
-7	45.8860	42.6525	39.6112	-1.49	1.40
-6	43.5912	40.5800	37.7429	-1.47	1.39
-5	41.4249	38.6207	35.9739	-1.45	1.37
-4	39.3792	36.7676	34.2983	-1.43	1.35

-3	37.4465	35.0144	32.7108	-1.41	1.33
-2	35.6202	33.3552	31.2062	-1.38	1.31
-1	33.8936	31.7844	29.7796	-1.36	1.29
0	32.2608	30.2968	28.4267	-1.34	1.28
1	30.7162	28.8875	27.1431	-1.32	1.26
2	29.2545	27.5519	25.9250	-1.29	1.24
3	27.8708	26.2858	24.7686	-1.27	1.22
4	26.5605	25.0851	23.6704	-1.25	1.20
5	25.3193	23.9462	22.6273	-1.23	1.18
6	24.1432	22.8656	21.6361	-1.20	1.16
7	23.0284	21.8398	20.6939	-1.18	1.14
8	21.9714	20.8659	19.7982	-1.15	1.12
9	20.9688	19.9409	18.9463	-1.13	1.09
10	20.0176	19.0621	18.1358	-1.11	1.07
11	19.1149	18.2270	17.3646	-1.08	1.05
12	18.2580	17.4331	16.6305	-1.06	1.03
13	17.4442	16.6782	15.9315	-1.03	1.01
14	16.6711	15.9601	15.2657	-1.01	0.99
15	15.9366	15.2770	14.6315	-0.98	0.96
16	15.2385	14.6268	14.0271	-0.96	0.94
17	14.5748	14.0079	13.4510	-0.93	0.92
18	13.9436	13.4185	12.9017	-0.91	0.90
19	13.3431	12.8572	12.3778	-0.88	0.87
20	12.7718	12.3223	11.8780	-0.86	0.85
21	12.2280	11.8126	11.4011	-0.83	0.83
22	11.7102	11.3267	10.9459	-0.81	0.80
23	11.2172	10.8634	10.5114	-0.78	0.78
24	10.7475	10.4216	10.0964	-0.75	0.75
25	10.3000	10.0000	9.7000	-0.75	0.75
26	9.8975	9.5974	9.2980	-0.76	0.76
27	9.5129	9.2132	8.9148	-0.80	0.80
28	9.1454	8.8465	8.5496	-0.84	0.83
29	8.7942	8.4964	8.2013	-0.87	0.86
30	8.4583	8.1621	7.8691	-0.91	0.90
31	8.1371	7.8428	7.5522	-0.95	0.93
32	7.8299	7.5377	7.2498	-0.98	0.97
33	7.5359	7.2461	6.9611	-1.02	1.00
34	7.2546	6.9673	6.6854	-1.06	1.04
35	6.9852	6.7008	6.4222	-1.10	1.07
36	6.7273	6.4459	6.1707	-1.13	1.11
37	6.4803	6.2021	5.9304	-1.17	1.14
38	6.2437	5.9687	5.7007	-1.21	1.18
39	6.0170	5.7454	5.4812	-1.25	1.22
40	5.7997	5.5316	5.2712	-1.29	1.25

41	5.5914	5.3269	5.0704	-1.33	1.29
42	5.3916	5.1308	4.8783	-1.37	1.33
43	5.2001	4.9430	4.6944	-1.41	1.36
44	5.0163	4.7630	4.5185	-1.45	1.40
45	4.8400	4.5905	4.3500	-1.49	1.44
46	4.6708	4.4252	4.1887	-1.53	1.47
47	4.5083	4.2666	4.0342	-1.57	1.51
48	4.3524	4.1145	3.8862	-1.61	1.55
49	4.2026	3.9686	3.7443	-1.65	1.59
50	4.0588	3.8287	3.6084	-1.70	1.62
51	3.9206	3.6943	3.4780	-1.74	1.66
52	3.7878	3.5654	3.3531	-1.78	1.70
53	3.6601	3.4416	3.2332	-1.82	1.74
54	3.5374	3.3227	3.1183	-1.87	1.78
55	3.4195	3.2085	3.0079	-1.91	1.82
56	3.3060	3.0989	2.9021	-1.95	1.85
57	3.1969	2.9935	2.8005	-2.00	1.89
58	3.0919	2.8922	2.7029	-2.04	1.93
59	2.9909	2.7948	2.6092	-2.08	1.97
60	2.8936	2.7012	2.5193	-2.13	2.01
61	2.8000	2.6112	2.4328	-2.17	2.05
62	2.7099	2.5246	2.3498	-2.22	2.09
63	2.6232	2.4413	2.2700	-2.26	2.13
64	2.5396	2.3611	2.1932	-2.31	2.17
65	2.4591	2.2840	2.1195	-2.36	2.21
66	2.3815	2.2098	2.0486	-2.40	2.25
67	2.3068	2.1383	1.9803	-2.45	2.29
68	2.2347	2.0695	1.9147	-2.49	2.34
69	2.1652	2.0032	1.8516	-2.54	2.38
70	2.0983	1.9393	1.7908	-2.59	2.42
71	2.0337	1.8778	1.7324	-2.63	2.46
72	1.9714	1.8186	1.6761	-2.68	2.50
73	1.9113	1.7614	1.6219	-2.73	2.54
74	1.8533	1.7064	1.5697	-2.78	2.58
75	1.7974	1.6533	1.5194	-2.83	2.63
76	1.7434	1.6021	1.4710	-2.88	2.67
77	1.6913	1.5528	1.4243	-2.92	2.71
78	1.6409	1.5051	1.3794	-2.97	2.75
79	1.5923	1.4592	1.3360	-3.02	2.80
80	1.5454	1.4149	1.2942	-3.07	2.84
81	1.5000	1.3721	1.2540	-3.12	2.88
82	1.4562	1.3308	1.2151	-3.17	2.93
83	1.4139	1.2910	1.1776	-3.22	2.97
84	1.3730	1.2525	1.1415	-3.27	3.01

85	1.3335	1.2153	1.1066	-3.32	3.06
86	1.2953	1.1794	1.0730	-3.38	3.10
87	1.2583	1.1448	1.0405	-3.43	3.15
88	1.2226	1.1113	1.0092	-3.48	3.19
89	1.1880	1.0789	0.9789	-3.53	3.24
90	1.1546	1.0476	0.9497	-3.58	3.28
91	1.1223	1.0174	0.9215	-3.64	3.33
92	1.0910	0.9882	0.8942	-3.69	3.37
93	1.0607	0.9599	0.8679	-3.74	3.42
94	1.0314	0.9326	0.8424	-3.80	3.46
95	1.0030	0.9061	0.8179	-3.85	3.51
96	0.9756	0.8806	0.7941	-3.90	3.55
97	0.9490	0.8558	0.7711	-3.96	3.60
98	0.9232	0.8319	0.7489	-4.01	3.64
99	0.8983	0.8088	0.7275	-4.07	3.69
100	0.8741	0.7863	0.7067	-4.12	3.74
101	0.8507	0.7646	0.6867	-4.18	3.78
102	0.8281	0.7436	0.6672	-4.23	3.83
103	0.8061	0.7233	0.6484	-4.29	3.88
104	0.7848	0.7036	0.6303	-4.34	3.92
105	0.7641	0.6845	0.6127	-4.40	3.97
106	0.7441	0.6661	0.5957	-4.46	4.02
107	0.7247	0.6482	0.5792	-4.51	4.07
108	0.7059	0.6308	0.5632	-4.57	4.12
109	0.6877	0.6140	0.5478	-4.63	4.16
110	0.6700	0.5977	0.5328	-4.69	4.21
111	0.6528	0.5820	0.5183	-4.74	4.26
112	0.6361	0.5667	0.5043	-4.80	4.31
113	0.6200	0.5518	0.4907	-4.86	4.36
114	0.6043	0.5374	0.4775	-4.92	4.41
115	0.5891	0.5235	0.4648	-4.98	4.45
116	0.5743	0.5100	0.4524	-5.04	4.50
117	0.5600	0.4968	0.4404	-5.10	4.55
118	0.5460	0.4841	0.4288	-5.16	4.60
119	0.5325	0.4717	0.4175	-5.22	4.65
120	0.5194	0.4597	0.4066	-5.28	4.70

## Discharging Sensor

R80°C=50KΩ ± 3%

B25/80°C=4450K ± 3%

Temp.((°C))	Max.(KΩ)	Normal(KΩ)	Min.(KΩ)	Tolerance(°C)	
-30	14646.0505	12061.7438	9924.4999	-2.96	2.45
-29	13654.1707	11267.8730	9290.2526	-2.95	2.44
-28	12735.8378	10531.3695	8700.6388	-2.93	2.44
-27	11885.1336	9847.7240	8152.2338	-2.92	2.43
-26	11096.6531	9212.8101	7641.8972	-2.91	2.42
-25	10365.4565	8622.8491	7166.7474	-2.90	2.42
-24	9687.0270	8074.3787	6724.1389	-2.88	2.41
-23	9057.2314	7564.2244	6311.6413	-2.87	2.41
-22	8472.2852	7089.4741	5927.0206	-2.86	2.40
-21	7928.7217	6647.4547	5568.2222	-2.84	2.39
-20	7423.3626	6235.7109	5233.3554	-2.83	2.39
-19	6953.2930	5851.9864	4920.6791	-2.82	2.38
-18	6515.8375	5494.2064	4628.5894	-2.80	2.37
-17	6108.5393	5160.4621	4355.6078	-2.79	2.37
-16	5729.1413	4848.9963	4100.3708	-2.77	2.36
-15	5375.5683	4558.1906	3861.6201	-2.76	2.35
-14	5045.9114	4286.5535	3638.1938	-2.75	2.34
-13	4738.4141	4032.7098	3429.0191	-2.73	2.34
-12	4451.4586	3795.3910	3233.1039	-2.72	2.33
-11	4183.5548	3573.4260	3049.5312	-2.70	2.32
-10	3933.3289	3365.7336	2877.4527	-2.69	2.31
-9	3699.5139	3171.3148	2716.0828	-2.67	2.30
-8	3480.9407	2989.2460	2564.6945	-2.66	2.29
-7	3276.5302	2818.6731	2422.6139	-2.64	2.28
-6	3085.2854	2658.8058	2289.2164	-2.63	2.28
-5	2906.2851	2508.9126	2163.9230	-2.61	2.27
-4	2738.6777	2368.3158	2046.1961	-2.60	2.26
-3	2581.6752	2236.3876	1935.5371	-2.58	2.25
-2	2434.5487	2112.5459	1831.4826	-2.56	2.24
-1	2296.6230	1996.2509	1733.6024	-2.55	2.23
0	2167.2730	1887.0018	1641.4966	-2.53	2.22
1	2045.9191	1784.3336	1554.7931	-2.52	2.21
2	1932.0242	1687.8144	1473.1460	-2.50	2.20
3	1825.0899	1597.0431	1396.2333	-2.48	2.19
4	1724.6540	1511.6468	1323.7551	-2.47	2.17
5	1630.2870	1431.2787	1255.4324	-2.45	2.16
6	1541.5904	1355.6163	1191.0048	-2.43	2.15
7	1458.1938	1284.3593	1130.2298	-2.41	2.14
8	1379.7528	1217.2282	1072.8813	-2.40	2.13
9	1305.9472	1153.9626	1018.7481	-2.38	2.12

10	1236.4792	1094.3200	967.6334	-2.36	2.11
11	1171.0715	1038.0743	919.3533	-2.35	2.09
12	1109.4661	985.0146	873.7359	-2.33	2.08
13	1051.4226	934.9440	830.6210	-2.31	2.07
14	996.7169	887.6792	789.8583	-2.29	2.06
15	945.1404	843.0486	751.3077	-2.27	2.04
16	896.4981	800.8922	714.8380	-2.26	2.03
17	850.6086	761.0603	680.3265	-2.24	2.02
18	807.3024	723.4134	647.6580	-2.22	2.00
19	766.4212	687.8205	616.7252	-2.20	1.99
20	727.8172	654.1596	587.4271	-2.18	1.98
21	691.3524	622.3161	559.6694	-2.16	1.96
22	656.8979	592.1831	533.3634	-2.14	1.95
23	624.3328	563.6604	508.4261	-2.12	1.93
24	593.5446	536.6540	484.7796	-2.10	1.92
25	564.4275	511.0760	462.3510	-2.09	1.90
26	536.9865	486.9352	441.1516	-2.07	1.89
27	511.0105	464.0500	421.0258	-2.05	1.87
28	486.4151	442.3499	401.9146	-2.03	1.86
29	463.1208	421.7683	383.7626	-2.01	1.84
30	441.0535	402.2430	366.5175	-1.99	1.83
31	420.1431	383.7151	350.1301	-1.97	1.81
32	400.3242	366.1295	334.5542	-1.95	1.80
33	381.5350	349.4341	319.7460	-1.93	1.78
34	363.7176	333.5801	305.6645	-1.90	1.76
35	346.8176	318.5216	292.2709	-1.88	1.75
36	330.7839	304.2151	279.5286	-1.86	1.73
37	315.5682	290.6199	267.4031	-1.84	1.71
38	301.1254	277.6976	255.8620	-1.82	1.70
39	287.4128	265.4119	244.8745	-1.80	1.68
40	274.3905	253.7288	234.4118	-1.78	1.66
41	262.0206	242.6161	224.4465	-1.76	1.64
42	250.2676	232.0436	214.9529	-1.74	1.63
43	239.0983	221.9825	205.9065	-1.71	1.61
44	228.4809	212.4060	197.2844	-1.69	1.59
45	218.3860	203.2887	189.0648	-1.67	1.57
46	208.7855	194.6066	181.2273	-1.65	1.55
47	199.6531	186.3369	173.7524	-1.63	1.54
48	190.9639	178.4584	166.6217	-1.60	1.52
49	182.6945	170.9508	159.8181	-1.58	1.50
50	174.8228	163.7951	153.3249	-1.56	1.48
51	167.3280	156.9733	147.1268	-1.53	1.46
52	160.1904	150.4683	141.2090	-1.51	1.44
53	153.3914	144.2641	135.5577	-1.49	1.42



54	146.9136	138.3454	130.1598	-1.47	1.40
55	140.7403	132.6980	125.0027	-1.44	1.38
56	134.8559	127.3081	120.0746	-1.42	1.36
57	129.2457	122.1630	115.3645	-1.40	1.34
58	123.8956	117.2504	110.8618	-1.37	1.32
59	118.7926	112.5589	106.5564	-1.35	1.30
60	113.9241	108.0776	102.4388	-1.32	1.28
61	109.2784	103.7961	98.5000	-1.30	1.26
62	104.8443	99.7046	94.7315	-1.28	1.23
63	100.6112	95.7939	91.1253	-1.25	1.21
64	96.5692	92.0553	87.6735	-1.23	1.19
65	92.7088	88.4805	84.3690	-1.20	1.17
66	89.0211	85.0614	81.2048	-1.18	1.15
67	85.4976	81.7908	78.1744	-1.15	1.12
68	82.1303	78.6615	75.2715	-1.13	1.10
69	78.9116	75.6668	72.4902	-1.10	1.08
70	75.8343	72.8004	69.8249	-1.08	1.06
71	72.8916	70.0561	67.2703	-1.05	1.03
72	70.0770	67.4283	64.8213	-1.03	1.01
73	67.3844	64.9115	62.4731	-1.00	0.99
74	64.8080	62.5006	60.2211	-0.98	0.96
75	62.3423	60.1906	58.0609	-0.95	0.94
76	59.9821	57.9770	55.9885	-0.92	0.92
77	57.7223	55.8552	53.9998	-0.90	0.89
78	55.5583	53.8210	52.0912	-0.87	0.87
79	53.4856	51.8706	50.2591	-0.85	0.84
80	51.5000	50.0000	48.5000	-0.85	0.84
81	49.7063	48.2057	46.7083	-0.85	0.85
82	47.9835	46.4842	44.9911	-0.89	0.89
83	46.3286	44.8323	43.3452	-0.93	0.92
84	44.7385	43.2468	41.7672	-0.96	0.95
85	43.2105	41.7248	40.2540	-1.00	0.99
86	41.7386	40.2604	38.7996	-1.03	1.02
87	40.3241	38.8545	37.4048	-1.07	1.06
88	38.9643	37.5045	36.0668	-1.11	1.09
89	37.6569	36.2078	34.7831	-1.14	1.13
90	36.3996	34.9622	33.5513	-1.18	1.16
91	35.1903	33.7653	32.3689	-1.22	1.19
92	34.0269	32.6151	31.2338	-1.26	1.23
93	32.9075	31.5096	30.1438	-1.30	1.27
94	31.8302	30.4467	29.0970	-1.33	1.30
95	30.7933	29.4246	28.0915	-1.37	1.34
96	29.7950	28.4417	27.1254	-1.41	1.37
97	28.8337	27.4961	26.1970	-1.45	1.41

98	27.9078	26.5864	25.3048	-1.49	1.44
99	27.0160	25.7110	24.4470	-1.53	1.48
100	26.1569	24.8685	23.6222	-1.57	1.52
101	25.3290	24.0574	22.8291	-1.61	1.55
102	24.5311	23.2765	22.0662	-1.65	1.59
103	23.7620	22.5245	21.3323	-1.69	1.63
104	23.0205	21.8002	20.6261	-1.73	1.66
105	22.3055	21.1025	19.9465	-1.77	1.70
106	21.6159	20.4303	19.2924	-1.81	1.74
107	20.9508	19.7825	18.6626	-1.85	1.77
108	20.3091	19.1582	18.0563	-1.89	1.81
109	19.6899	18.5564	17.4723	-1.93	1.85
110	19.0924	17.9761	16.9098	-1.98	1.89
111	18.5157	17.4166	16.3680	-2.02	1.93
112	17.9590	16.8769	15.8458	-2.06	1.96
113	17.4214	16.3564	15.3427	-2.10	2.00
114	16.9023	15.8542	14.8577	-2.15	2.04
115	16.4010	15.3696	14.3902	-2.19	2.08
116	15.9167	14.9020	13.9394	-2.23	2.12
117	15.4489	14.4506	13.5047	-2.27	2.16
118	14.9968	14.0149	13.0855	-2.32	2.19
119	14.5599	13.5942	12.6811	-2.36	2.23
120	14.1376	13.1879	12.2909	-2.41	2.27
121	13.7294	12.7955	11.9144	-2.45	2.31
122	13.3347	12.4165	11.5510	-2.50	2.35
123	12.9531	12.0503	11.2003	-2.54	2.39
124	12.5840	11.6965	10.8617	-2.58	2.43
125	12.2270	11.3545	10.5348	-2.63	2.47
126	11.8817	11.0240	10.2191	-2.68	2.51
127	11.5475	10.7046	9.9142	-2.72	2.55
128	11.2242	10.3957	9.6197	-2.77	2.59
129	10.9112	10.0970	9.3352	-2.81	2.63
130	10.6084	9.8082	9.0602	-2.86	2.67
131	10.3151	9.5288	8.7945	-2.91	2.71
132	10.0312	9.2586	8.5378	-2.95	2.75
133	9.7563	8.9971	8.2895	-3.00	2.80
134	9.4901	8.7441	8.0495	-3.05	2.84
135	9.2322	8.4993	7.8175	-3.09	2.88
136	8.9824	8.2623	7.5931	-3.14	2.92
137	8.7404	8.0329	7.3760	-3.19	2.96
138	8.5059	7.8108	7.1660	-3.24	3.00
139	8.2787	7.5958	6.9629	-3.29	3.04
140	8.0584	7.3875	6.7664	-3.33	3.09

## 6. System Configuration

### 6.1 System Configuration

After the installation and test operation of the room air conditioner have been completed, it should be operated and handled as described below. Every user would like to know the correct method of operation of the room air conditioner, to check if it is capable of cooling (or heating) well, and to know a clever method of using it. In order to meet this expectation of the users, giving sufficient explanations taking enough time can be said to reduce about 80% of the requests for servicing. However good the installation work is and however good the functions are, the customer may blame either the room air conditioner or its installation work because of improper handling. The installation work and handing over of the unit can only be considered to have been completed when its handling has been explained to the user without using technical terms but giving full knowledge of the equipment.

### 6.2 Instruction

# Parts and Functions

## Indoor Unit

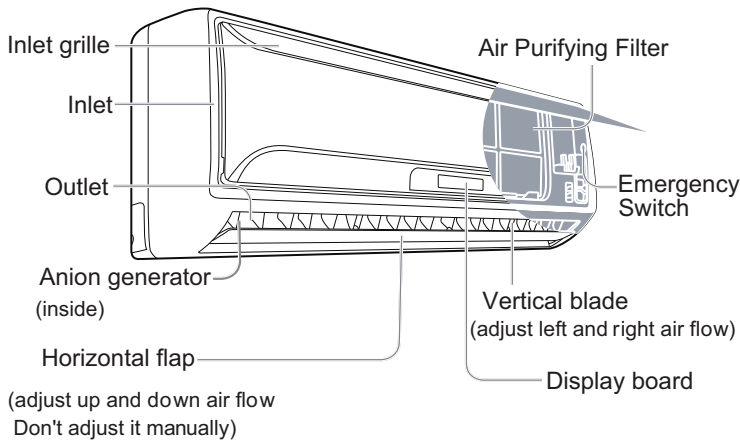

Actual inlet grille may vary from the one shown in the manual according to the product purchased

### Display board for 12:

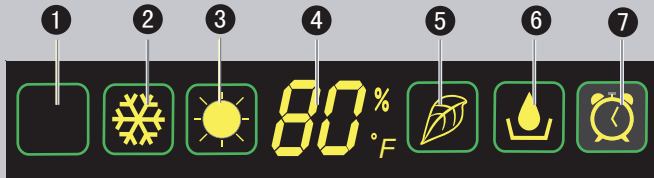

- 1 Singal receiver hole
  - 2 COOL display
  - 3 HEAT display
  - 4 TEMP display
  - 5 HEALTH display
  - 6 Dry display
  - 7 TIMER OFF display
- (If the unit which you purchased has healthy function, follow it. If not, please ignore.)
- 6 Dry display
  - 7 TIMER OFF display
  - TIMER ON display
  - SLEEP display

### Display board for 18:

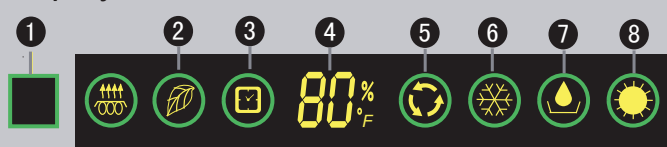

- 1 Remote signal receiver
- 2 HEALTH display
- 3 TIMER OFF display
- 4 TEMP display
- 5 AUTO display
- 6 COOL display
- 7 Dry display
- 8 HEAT display

## Outdoor Unit

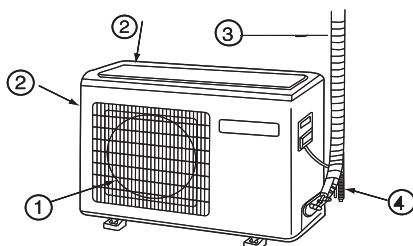

- 1 OUTLET
- 2 INLET
- 3 CONNECTING PIPING AND ELECTRICAL WIRING
- 4 DRAIN HOSE

## Remote controller

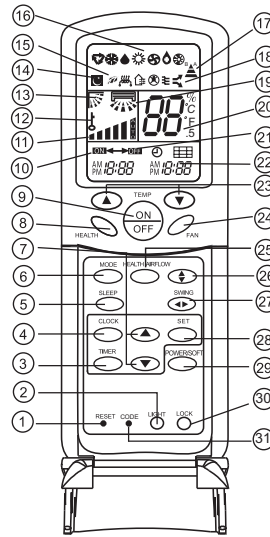

- 8. HEALTH button
- 9. ON/OFF button
- 10. TIMER ON display
- 11. FAN SPEED display



- 12. LOCK display
- 13. SWING UP/DOWN display
- 14. SLEEP display
- 15. HEALTH display
- 16. Operation mode display

Operation mode	AUTO	COOL	DRY	HEAT	FAN
Remote controller					

- 17. Singal sending display
  - 18. POWER/SOFT display
  - 19. Left/right air flow display
  - 20. TEMP display
  - 21. TIMER OFF display
  - 22. TIMER display
  - 23. TEMP button
  - 24. FAN button
  - 25. HEALTH AIRFLOW button
  - 26. SWING UP/DOWN button
  - 27. SWING LEFT/RIGHT button
  - 28. SET button
  - 29. POWER/SOFT button
  - 30. LOCK button
  - 31. CODE button
- If pressed, the other buttons will be disabled. Press it once again, lock will be cancelled.
- Use to select CODE A or B which will be displayed on LCD. Please select A without special explanation.

- 1. RESET button
- When the remote controller appears abnormal, use a sharp pointed article to press this button to reset the remote controller normal.
- 2. LIGHT button
- Control the lightening and extinguishing of the indoor LED display board.
- 3. TIMER button
- 4. CLOCK button
- 5. SLEEP button
- 6. MODE button
- 7. HOUR button

### NOTE:

Cooling only unit do not have functions and displays related with heating.

## Loading of the battery

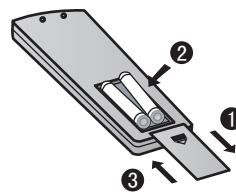

- 1 Remove the battery cover;
- 2 Load the batteries as illustrated. 2 R-03 batteries, resetting key (cylinder);
- 3 Be sure that the loading is in line with the "+" and "-";
- 4 Load the battery, then put on the cover again.

### Note:

- The distance between the signal transmission head and the receiver hole should be within 7m without any obstacle as well.
- When electronic-started type fluorescent lamp or change-over type fluorescent lamp or wireless telephone is installed in the room, the receiver is apt to be disturbed in receiving the signals, so the distance to the indoor unit should be shorter.
- Full display or unclear display during operation indicates the batteries have been used up. Please change batteries.
- If the remote controller can't run normally during operation, please remove the batteries and reload several minutes later.

### Hint:

Remove the batteries in case unit won't be in usage for a long period. If there are any display after taking-out, just need to press reset key.

# Operation

## Clock set

Press CLOCK button, "AM" or "PM" flashes.  
 Press  $\Delta$  or  $\nabla$  to set correct time. Each press will increase or decrease 1min. If the button is kept pressed,time will change quickly. After time setting is confirmed,press SET, "AM" and "PM" stop flashing,while clock starts working.



## Base Operation

Remote controller

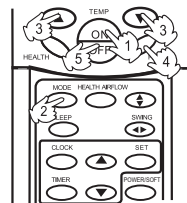

### 1. Unit start

Press ON/OFF on the remote controller, unit starts.

### 2. Select operation mode

Press MODE button. For each press, operation mode changes as follows:

Remote controller:



### 3. Select temp.setting

Press  $\Delta$  /  $\nabla$  button

- $\Delta$  Every time the button is pressed, temp.setting increase 2°F,if kept depressed, it will increase rapidly
- $\nabla$  Every time the button is pressed, temp.setting decrease 2°F,if kept depressed, it will decrease rapidly

Select a desired temperature.

### 4. Fan speed selection

Press FAN button. For each press, fan speed changes as follows:

Remote controller:



Air conditioner is running under displayed fan speed.  
 When FAN is set to AUTO, the air conditioner automatically adjusts the fan speed according to room temperature.

Operation Mode	Display Board	Remote Controller	Note
AUTO			Under the mode of auto operation, air conditioner will automatically select Cool or Heat operation according to room temperature. When FAN is set to AUTO, the air conditioner automatically adjusts the fan speed according to room temperature.
COOL			
DRY			In DRY mode, when room temperature becomes lower than temp.setting about +4 °F,unit will run intermittently at LOW speed regardless of FAN setting.
HEAT			
FAN	nothing		In FAN operation mode, the unit will not operate in COOL or HEAT mode but only in FAN mode ,AUTO is not available in FAN mode.And temp.setting is disabled. In FAN mode,SLEEP operation is not available.

## Emergency operation and test operation

### Emergency Operation:

- Use this operation only when the remote controller is defective or lost.
- When the emergency operation switch is pressed, the "Pi" sound is heard once, which means the start of this operation.
- In this operation, the system automatically selects the operation modes, cooling or fan or heat, according to the room temperature.
- When machine is running in emergency, the set value of temperature and wind speed couldn't be altered; meanwhile, it can't operate for dehumidifying or under timing mode.

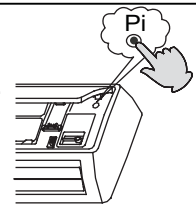

### Test operation:

Test operation switch is the same as emergency switch.

- Use this switch in the test operation when the room temperature is below 60°F, do not use it in the normal operation.
- Continue to press the test operation switch for more than 5 seconds. After you hear the "Pi" sound twice, release your finger from the switch: the cooling operation starts with the air flow speed "Hi".

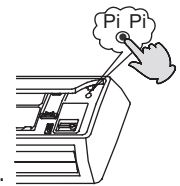

## Air Flow Direction Adjustment

### 1. Status display of air flow

Vertical flap

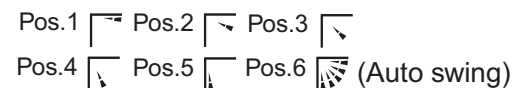

### 2. Left and right air flow adjustment(manual)

Move the vertical blade by a knob on air conditioner to adjust left and right direction referring to Fig.

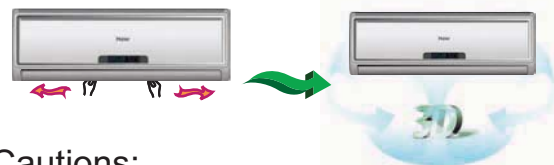

### Cautions:

- When adjusting the flap by hand,turn off the unit.
- When humidity is high,condensate water might occur at air outlet if all vertical louvers are adjusted to left or right.
- It is advisable not to keep horizontal flap at downward position for a long time in COOL or DRY mode , otherwise, condensate water might occur.

Note:

When restart after remote turning off, the remote controller will automatically memorize the previous set swing position.

# Operation

## Sleep Operation

Before going to bed, you can simply press the SLEEP button and unit will operate in SLEEP mode and bring you a sound sleep.



### Use of SLEEP function

After the unit starts, set the operation status, then press SLEEP button before which the clock must be adjusted and time being set.

### Operation Mode

#### 1. In COOL, DRY mode

1 hours after SLEEP mode starts, temp. will become about 2°F higher than temp. setting. After another 1 hours, temp. rises about 2°F further. The unit will run for further 6 hours then stops. Temp. is higher than temp. setting so that room temperature won't be too low for your sleep.

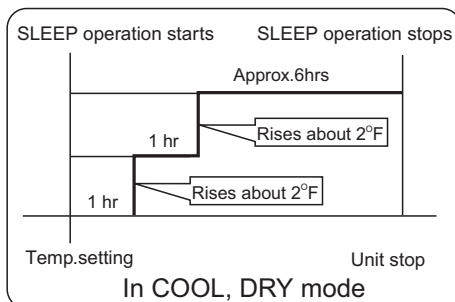

#### 2. In HEAT mode

1 hours after SLEEP mode starts, temp will become about 4°F lower than temp. setting. After another 1 hours, temp decrease about 4°F further. After more another 3 hours, temp. rises about 2°F further. The unit will run for further 3 hours then stops. Temp. is lower than temp. setting so that room temperature won't be too high for your sleep.

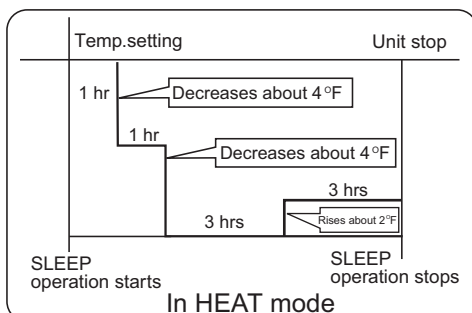

#### 3. In AUTO mode

The unit operates in corresponding sleep mode adapted to the automatically selected operation mode.

#### 4. In FAN mode

It has no SLEEP function.

#### 5. Set the wind speed change when sleeping

If the wind speed is high or middle before setting for the sleep, set for lowering the wind speed after sleeping. If it is low wind, no change.

#### 6. Note to the power failure resume:

press the sleep button ten times in five seconds and enter this function after hearing four sounds. And press the sleep button ten times within five seconds and leave this function after hearing two sounds.

#### NOTE:

With the power failure resume, when setting the TIMER ON, TIMER OFF and TIMER ON/OFF, it's memorized as shutdown status when resuming after power out.

## POWER/SOFT Operation

### (1) POWER Operation

When you need rapid heating or cooling, you can use this function. In COOL mode, fan speed automatically takes high speed of AUTO fan mode. In HEAT mode, fan speed automatically takes medial speed of AUTO fan mode.

### (2) SOFT Operation

You can use this function when silence is needed for rest or reading. In SOFT operation mode, fan speed automatically takes low speed of AUTO fan mode.

#### Note:

During POWER operation, in rapid HEAT or COOL mode, the room will show inhomogeneous temperature distribution. Long period SOFT operation will cause effect of not too cool or not too warm.

To cancel POWER or SOFT operation

Press POWER/SOFT button again, POWER or SOFT disappears.

## HEALTH Operation



### Healthy Negative ion

The anion generator in the air conditioner can generate a lot of anion effectively balance the quantity of positive and anion in the air and also to kill bacteria and speed up the dust sediment in the room and finally clean the air in the room.

# Operation

## Timer On/Off On-Off Operation

Set clock correctly before starting TIMER operation.

1. After unit starts, select your desired operation mode.
2. Press TIMER button to change TIMER mode. Every time the button is pressed, display changes as follows:

Remote controller:



Then select your desired TIMER mode (TIMER ON or TIMER OFF or TIMER ON-OFF). "ON" or "OFF" will flash.

3. Press HOUR  $\uparrow$  /  $\downarrow$  button to set time.

It can be adjusted within 24 hours.

4. After setting correct time, press SET button to confirm "ON" or "OFF" on the remote controller stops flashing.

5. Cancel TIMER mode

Just press TIMER button several times until TIMER mode disappears.

Hints:

After replacing batteries or a power failure happens, time setting should be reset.

Remote controller possesses memory function, when use TIMER mode next time, just press SET button after mode selecting if time setting is the same as previous one.

According to the Time setting sequence of TIMER ON or TIMER OFF, either Start-Stop or Stop-Start can be achieved.

## Health airflow Operation

1. Press ON/OFF to starting

Setting the comfort work conditions.

2. The setting of health airflow function

1). Press the button of health airflow,  $\square$  appears on the display. Horizontal airflow sending. Avoid the strong airflow blows direct to the body.

2). Press the button of health airflow again,  $\square$  appears on the display. Downward airflow sending. Avoid the strong airflow blows direct to the body.

3. The cancel of the health airflow function

Press the button of health airflow again, the unit goes on working under the condition before the setting of health airflow function.

Notice: Cannot pull direct the flap by hand. Otherwise, the grille will run incorrectly. If the grille is not run correctly, stop for a minute and then start, adjusting by remote controller.

Note:

1. After setting the health airflow function, the position grill is fixed.

2. In heating, it is better to select the  $\square$  mode.

3. In cooling, it is better to select the  $\square$  mode.

4. In cooling and dry, using the air conditioner for a long time under the high air humidity, a phenomenon falling drips of water occurs at the grille .

## IMPORTANT INFORMATION REGARDING THE REFRIGERANT USED

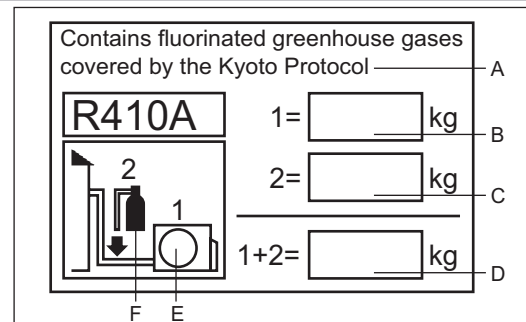

This product contains fluorinated greenhouse gases covered by the Kyoto Protocol. Do not vent into the atmosphere.

Refrigerant type: R410A

GWP\* value: 1975

GWP=global warming potential

Please fill in with indelible ink,

- 1 the factory refrigerant charge of the product
- 2 the additional refrigerant amount charged in the field and
- 1+2 the total refrigerant charge

on the refrigerant charge label supplied with the product. The filled out label must be adhered in the proximity of the product charging port (e.g. onto the inside of the stop valve cover).

A contains fluorinated greenhouse gases covered by the Kyoto Protocol

B factory refrigerant charge of the product: see unit name plate

C additional refrigerant amount charged in the field







D total refrigerant charge

E outdoor unit

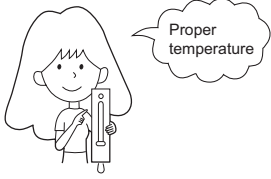
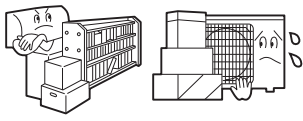

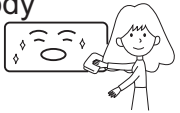
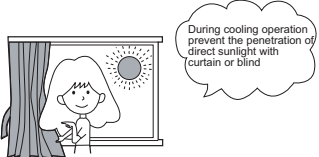
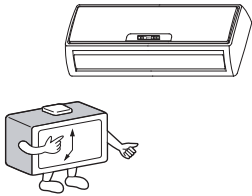
F refrigerant cylinder and manifold for charging

# Maintenance

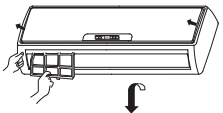
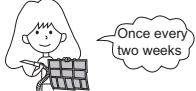
## For Smart Use of The Air Conditioner

<p><b>Setting of proper room temperature</b></p> 	<p><b>Do not block the air inlet or outlet</b></p> 	<p><b>Remote Controller</b></p>  <p>Do not use water, wipe the controller with a dry cloth. Do not use glass cleaner or chemical cloth.</p>	<p><b>Indoor Body</b></p>  <p>Wipe the air conditioner by using a soft and dry cloth. For serious stains, use a neutral detergent diluted with water. Wring the water out of the cloth before wiping, then wipe off the detergent completely.</p>
<p><b>Close doors and windows during operation</b></p> 	<p><b>Use the timer effectively</b></p> 	<p><b>Do not use the following for cleaning</b></p>  <p>Gasoline, benzene, thinner or cleanser may damage the coating of the unit.</p>  <p>Hot water over 40°C (104°F) may cause discoloring or deformation.</p>	
<p><b>If the unit is not to be used for a long time, turn off the power supply main switch.</b></p> 	<p><b>Use the louvers effectively</b></p> 	<p><b>Air Filter cleaning</b></p> <ol style="list-style-type: none"> <li><b>1 Open the inlet grille by pulling it upward.</b></li> <li><b>2 Remove the filter.</b> Push up the filter's center tab slightly until it is released from the stopper, and remove the filter downward.</li> <li><b>3 Clean the filter.</b> Use a vacuum cleaner to remove dust, or wash the filter with water. After washing, dry the filter completely in the shade.</li> <li><b>4 Attach the filter.</b> Attach the filter correctly so that the "FRONT" indication is facing to the front. Make sure that the filter is completely fixed behind the stopper. If the right and left filters are not attached correctly, that may cause defects.</li> <li><b>5 Close the inlet grille.</b></li> </ol>  	

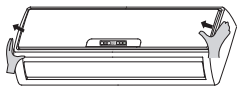
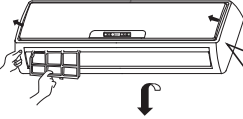
## Replacement of Air Purifying Filter

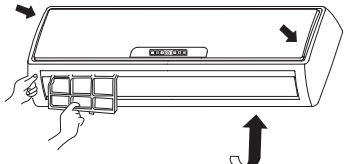
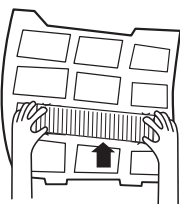
<p><b>1. Open the Inlet Grille</b> Prop up the inlet grille by using a small device named grille-support which located in the right side of the indoor unit.</p>  <p><b>2. Detach the standard air filter</b> Slide the knob slightly upward to release the filter, then withdraw it.</p>  <p>Detach old Air Purifying Filter</p> 	<p><b>4. Attach the standard air filter</b> (Necessary installation)</p>  <p><b>ATTENTION:</b> The white side of the photocatalyst air purifying filter face outside, and the black side face the unit. The green side of the bacteria-killing medium air purifying filter face outside, and the white side face the unit.</p> <p><b>5. Close the Inlet Grille</b> Close the Grille surely</p> <p><b>NOTE:</b></p> <ul style="list-style-type: none"> <li>The photocatalyst air purifying filter will be solarized in fixed time. In normal family, it will be solarized every 6 months.</li> <li>The bacteria-killing medium air purifying filter will be used for a long time, no need for replacement. But in the period of using them, you should remove the dust frequently by using vacuum cleaner or flapping them lightly, otherwise, its performance will be affected.</li> <li>Please keep the bacteria-killing medium air purifying filter in the cool and dry conditions avoid long time directly sunshine when you stop using it, or its ability of sterilization will be reduced.</li> </ul>
<p><b>3. Attach Air Purifying Filter</b> Put air purifying filter appliances into the right and left filter frames.</p> 	



# Cautions

## ⚠ WARNING

Please call Sales/Service Shop for the Installation.

Do not attempt to install the air conditioner by yourself because improper works may cause electric shock, fire, water leakage.

## ⚠ WARNING

When abnormality such as burnt-small found, immediately stop the operation button and contact sales shop.

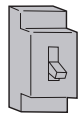

OFF



⚠  
STRICT  
ENFORCEMENT

Use an exclusive power source with a circuit breaker

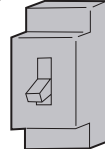

Check proper installation of the drainage securely



STRICT  
ENFORCEMENT

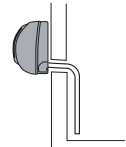

Connect power supply cord to the outlet completely



STRICT  
ENFORCEMENT

Use the proper voltage



STRICT  
ENFORCEMENT

1. Do not use power supply cord extended or connected in halfway
2. Do not install in the place where there is any possibility of inflammable gas leakage around the unit.
3. Do not get the unit exposed to vapor or oil steam.



PROHIBITION

Do not use power supply cord in a bundle.

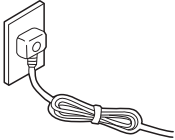

PROHIBITION

Take care not to damage the power supply cord.

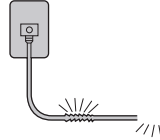

PROHIBITION

Do not insert objects into the air inlet or outlet.

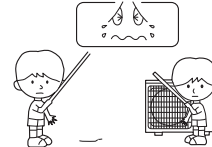

PROHIBITION

Do not start or stop the operation by disconnecting the power supply cord and so on.



PROHIBITION

Do not channel the air flow directly at people, especially at infants or the aged.



PROHIBITION

Do not try to repair or reconstruct by yourself.

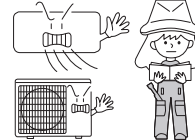

Connect the earth cable.

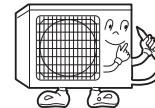

earthing

## ⚠ CAUTION

Do not use for the purpose of storage of food, art work, precise equipment, breeding, or cultivation.



PROHIBITION

Take fresh air occasionally especially when gas appliance is running at the same time.

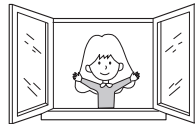

STRICT  
ENFORCEMENT

Do not operate the switch with wet hand.

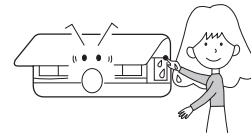

PROHIBITION

Do not install the unit near a fireplace or other heating apparatus.

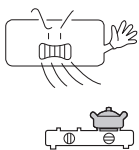

PROHIBITION

Check good condition of the installation stand

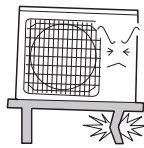

PROHIBITION

Do not pour water onto the unit for cleaning

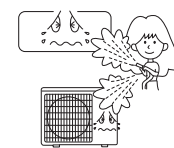

PROHIBITION

Do not place animals or plants in the direct path of the air flow

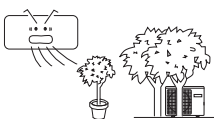

PROHIBITION

Do not place any objects on or climb on the unit.



PROHIBITION

Do not place flower vase or water containers on the top of the unit.





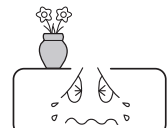

PROHIBITION



# Trouble shooting

# Cautions

Before asking for service, check the following first.

	Phenomenon	Cause or check points
Normal Performance inspection	The system does not restart immediately. 	<ul style="list-style-type: none"> <li>When unit is stopped, it won't restart immediately until 3 minutes have elapsed to protect the system.</li> <li>When the electric plug is pulled out and reinserted, the protection circuit will work for 3 minutes to protect the air conditioner.</li> </ul>
	Noise is heard 	<ul style="list-style-type: none"> <li>During unit operation or at stop, a swishing or gurgling noise may be heard. At first 2-3 minutes after unit start, this noise is more noticeable. (This noise is generated by refrigerant flowing in the system.)</li> <li>During unit operation, a cracking noise may be heard. This noise is generated by the casing expanding or shrinking because of temperature changes.</li> <li>Should there be a big noise from air flow in unit operation, air filter may be too dirty.</li> </ul>
	Smells are generated.	<ul style="list-style-type: none"> <li>This is because the system circulates smells from the interior air such as the smell of furniture, paint, cigarettes.</li> </ul>
	Mist or steam are blown out. 	<ul style="list-style-type: none"> <li>During COOL or DRY operation, indoor unit may blow out mist. This is due to the sudden cooling of indoor air.</li> </ul>
	In dry mode, fan speed can't be changed.	<ul style="list-style-type: none"> <li>In DRY mode, when room temperature becomes lower than temp. setting+3.6°F, unit will run intermittently at LOW speed regardless of FAN setting.</li> </ul>
Multiple check		<ul style="list-style-type: none"> <li>Is power plug inserted?</li> <li>Is there a power failure?</li> <li>Is fuse blownout?</li> </ul>
	Poor cooling 	<ul style="list-style-type: none"> <li>Is the air filter dirty? Normally it should be cleaned every 15 days.</li> <li>Are there any obstacles before inlet and outlet?</li> <li>Is temperature set correctly?</li> <li>Are there some doors or windows left open?</li> <li>Is there any direct sunlight through the window during the cooling operation?(Use curtain)</li> <li>Are there too much heat sources or too many people in the room during cooling operation?</li> </ul>

- Do not obstruct or cover the ventilation grille of the air conditioner. Do not put fingers or any other things into the inlet/outlet and swing louver.
- Do not allow children to play with the air conditioner. In no case should children be allowed to sit on the outdoor unit.

### Specifications

- The refrigerating circuit is leak-proof.

The machine is adaptive in following situation

1. Applicable ambient temperature range:

Cooling	Indoor	Maximum:D.B/W.B 32°C/23°C Minimum:D.B/W.B 21°C/15°C
	Outdoor	Maximum:D.B/W.B 43°C/26°C Minimum: D.B 18°C
Heating	Indoor	Maximum:D.B 27°C Minimum: D.B 0°C
	Outdoor	Maximum:D.B/W.B 24°C/18°C Minimum:D.B/W.B -7°C/-8°C
	Outdoor (INVERTER)	Maximum:D.B/W.B 24°C/18°C Minimum:D.B -15°C

- If the power supply cord is damaged, it must be replaced by the manufacturer or its service agent or a similar qualified person.
- If the fuse of indoor unit on PC board is broken, please change it with the type of T. 3.15A/ 250V. If the fuse of outdoor unit is broken, change it with the type of T.25A/250V
- The wiring method should be in line with the local wiring standard.
- After installation, the power plug should be easily reached.
- The waste battery should be disposed properly.
- The appliance is not intended for use by young children or infirm persons without supervision.
- Young children should be supervised to ensure that they do not play with the appliance.
- Please employ the proper power plug, which fit into the power supply cord.
- A breaker should be incorporated into fixed wiring. The breaker should be all-pole switch and the distance between its two contacts should be not less than 3mm.
- The power plug and connecting cable must have acquired the local attestation.
- In order to protect the units, please turn off the A/C first, and at least 30 seconds later, cutting off the power.

## 7 Service Diagnosis

### 7.1 Caution for Diagnosis

The operation lamp flashes when any of the following errors is detected.

1. When a protection device of the indoor or outdoor unit is activated or when the thermistor malfunctions, disabling equipment operation.
2. When a signal transmission error occurs between the indoor and outdoor units. In either case, conduct the diagnostic procedure described in the following pages.

### 7.2. Problem Symptoms and Measures

Symptom	Check Item	Details of Measure
None of the units operates	Check the power supply.	Check to make sure that the rated voltage is supplied.
	Check the indoor PCB	Check to make sure that the indoor PCB is broken
Operation sometimes stops.	Check the power supply.	A power failure of 2 to 10 cycles can stop air conditioner operation.
Equipment operates but does not cool, or does not heat (only for heat pump)	Check for faulty operation of the electronic expansion valve.	Set the units to cooling operation, and compare the temperatures of the liquid side connection pipes of the connection section among rooms to check the opening and closing operation of the electronic expansion valves of the individual units.
	Diagnosis by service port pressure and operating current.	Check for insufficient gas.
Large operating noise and vibrations	Check the installation condition.	Check to make sure that the required spaces for installation (specified in the Technical Guide, etc.) are provided.

### 7.3.Error Codes and Description indoor display

	Code indication		Description	Reference Page
	indoor	Outdoor (LED1 flash times)		
Indoorand Outdoor	E7	15	Communication fault between indoor and outdoor units	Page .59
Indoor Malfunction	E1		Room temperature sensor failure	Page .51
	E2		Heat-exchange sensor failure	Page .51
	E4		Indoor EEPROM error	Page .58
	E14		Indoor fan motor malfunction	Page .52
Outdoor Malfunction		1	Outdoor EEPROM error	Page .58
		2	The protection of IPM	Page .53
		3	Overcurrent protection of AC electricity for the outdoor model	
		4	Communication fault between the IPM and outdoor PCB	Page 55
		6	Power voltage is too high or low	Page .61
		8	Overheat protection for exhaust temperature	Page .57
		9	outdoor fan motor malfunction	
		10	Frost-removing temperature sensor failure	Page .56
		11	SUCK temperature sensor failure	Page .56
		12	Ambient temperature sensor failure	Page .56
		13	Exhaust temperature sensor failure	Page .56
		18	deviate from the normal for the compressor	Page .62
		19	Loop of the station detect error	Page .62
		24	Overcurrent of the compressor	Page .63
	25	Overcurrent protection for single-phase of the compressor	Page .63	

### 7.3.1 Thermistor or Related Abnormality (indoor unit)

<b>Indoor Display</b>	<p><b>E1:</b> Room temperature sensor failure</p> <p><b>E2:</b> Heat-exchange sensor failure</p>
<b>Method of Malfunction Detection</b>	the temperatures detected by the thermistors are used to determine thermistor errors
<b>Malfunction Decision Conditions</b>	when the thermistor input is more than 4.92V or less than 0.08V during compressor operation.
<b>Supposed Causes</b>	<p>* <b>Note:</b> The values vary slightly in some models</p> <ul style="list-style-type: none"> <li>■ Faulty connector connection</li> <li>■ Faulty thermistor</li> <li>■ Faulty PCB</li> </ul>
<b>Troubleshooting</b>	<p>* <b>Caution</b> Be sure to turn off power switch before connect or disconnect connector, or else parts damage may be occurred.</p>

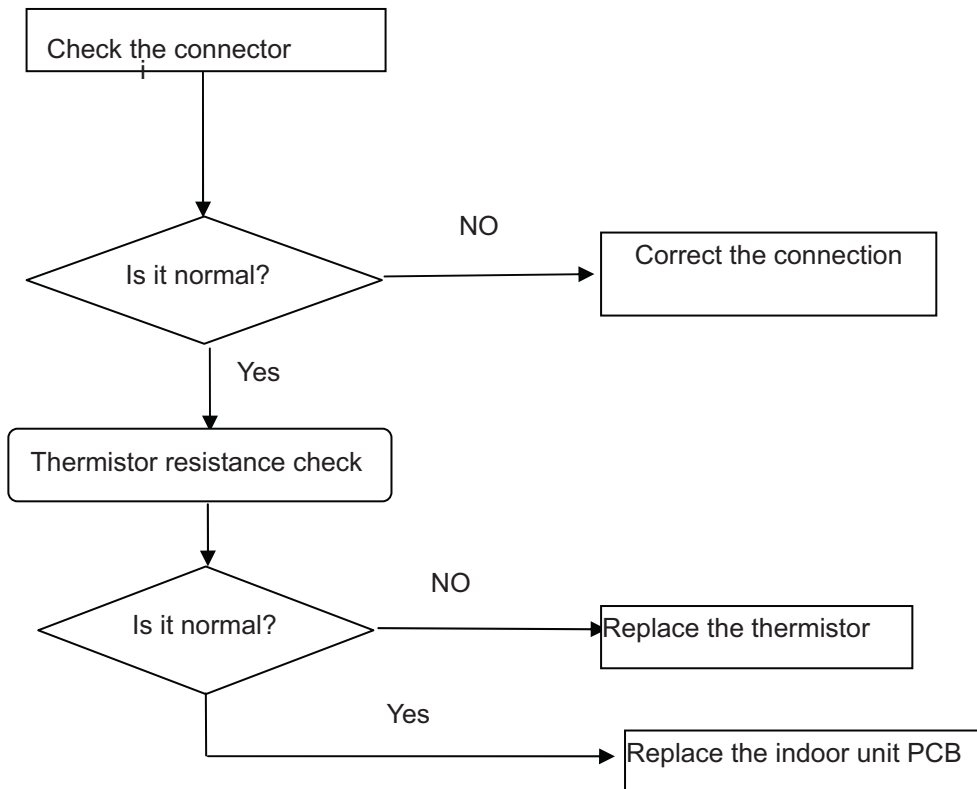

**Thermistor resistance check method:**

Remove the connector of the thermistor on the PCB, and measure the resistance of thermistor using tester. The relationship between normal temperature and resistance is shown in the value of indoor thermistor.

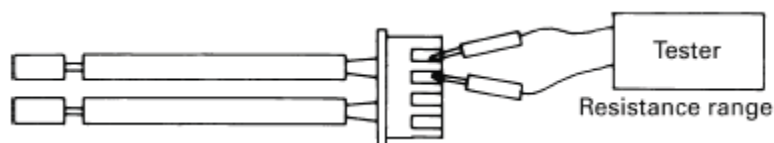

## 7.3.2 Indoor fan motor malfunction

**Indoor Display**    **E14**

**Method of Malfunction Detection**    The rotation speed detected by the Hall IC during fan motor operation is used to determine abnormal fan motor operation

**Malfunction Decision Conditions**    when the detected rotation feedback signal don't received in 2 minutes

**Supposed Causes**

- Operation halt due to breaking of wire inside the fan motor .
- Operation halt due to breaking of the fan motor lead wires
- Detection error due to faulty indoor unit PCB

### How to check Fan Motor (DC)

1. Check connector connection.
2. Check motor power supply voltage output (pins 1-4).
3. Check motor control voltage (pins 4-5).
4. Check rotation command voltage output (pins 4-6).
5. Check rotation pulse input (pins 4-7).

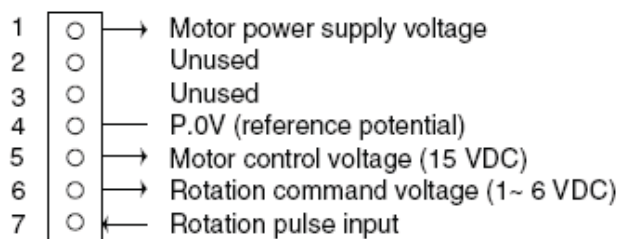

**Notes:**the a/c is electrifying,don't pull out or insert the terminals of the motor,else the motor would be damaged

**Troubleshooting**    \* **Caution**    Be sure to turn off power switch before connect or disconnect connector,    or else parts damage may be occurred.

Turn off power supply and rotate fan by hand



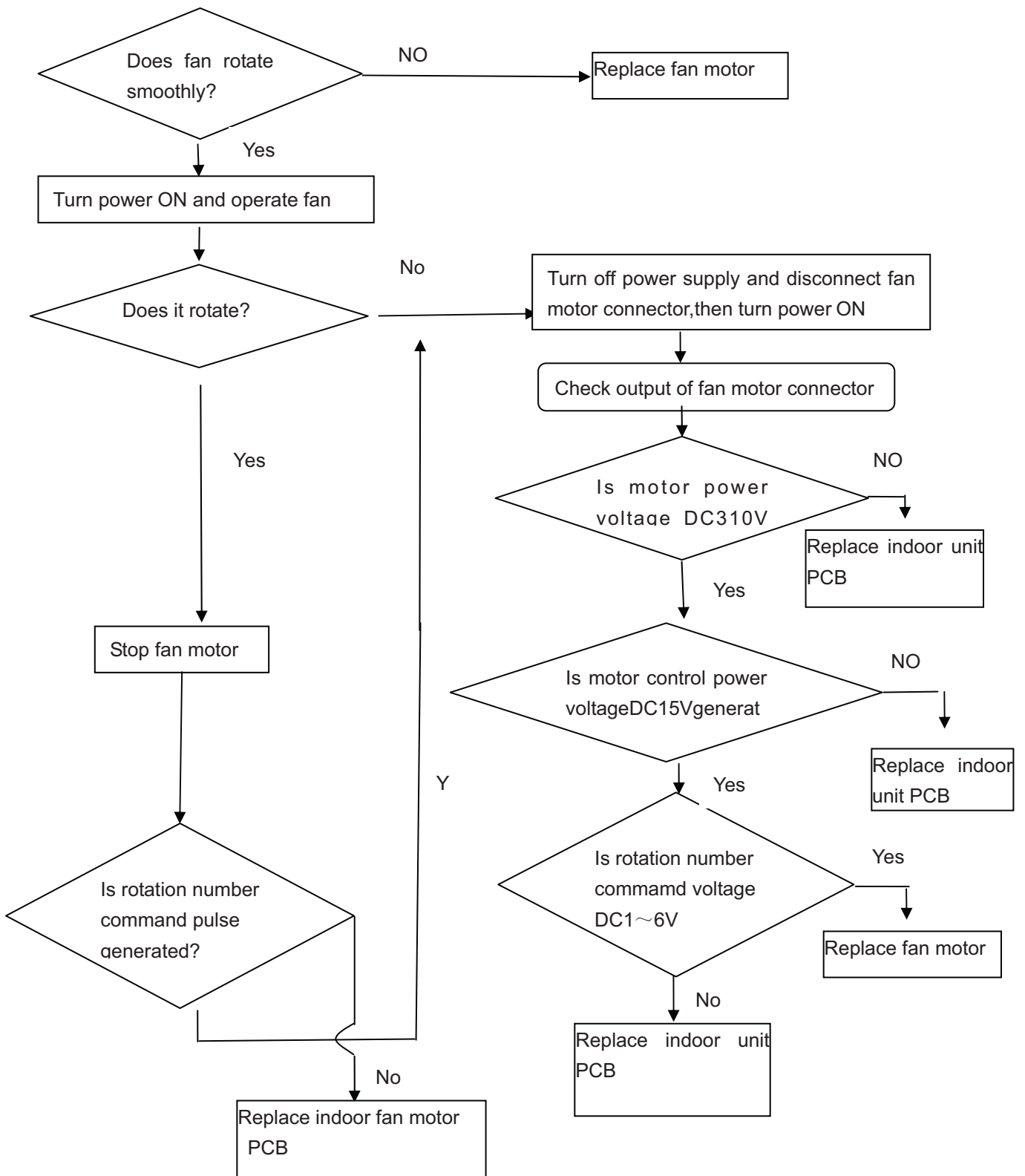

### 7.3.3 IPM protection

outdoor display LED1 flash 2 times: Indoor Display F1

**Method of Malfunction Detection** IPM protection is detected by checking the compressor running condition and so on.

**Malfunction Decision Conditions**

- The system leads to IPM protection due to over current
- The compressor faulty leads to IPM protection
- circuit component of IPM is broken and led to IPM protection

**Supposed Causes**

- IPM protection dues to the compressor faulty
- IPM protection dues to faulty PCB of IPM module
- Compressor wiring disconnected

**Troubleshooting** \* **Caution** Be sure to turn off power switch before connect or disconnect connector, or else parts damage may be occurred.

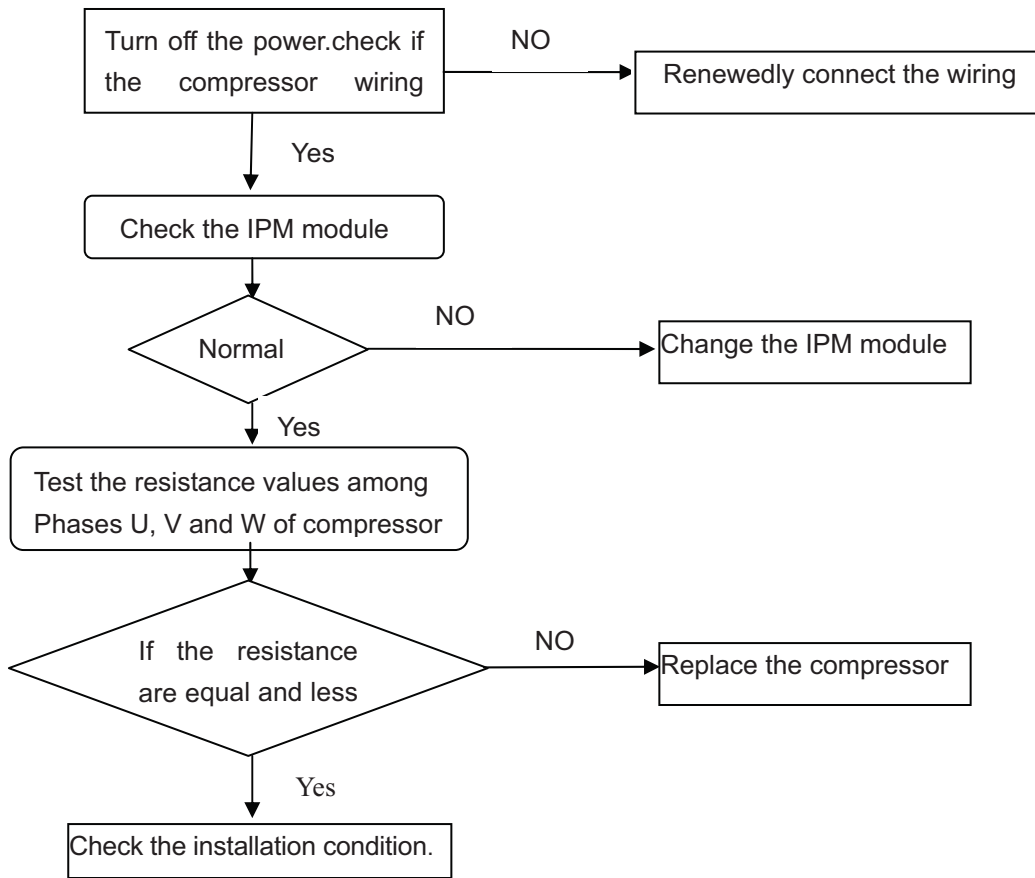

**Check the IPM module method:**

Disconnect the compressor harness connector from the outdoor unit PCB. To disengage the connector, press the protrusion on the connector. Then, to measure resistance between P (+) and N (-) and the U, V and W terminals of the compressor connector with a multi-tester. Evaluate the measurement results for a pass/fail judgment.

N(-)terminal of tester(P(+)for digital tester)	P(+)	UVW	P(-)	UVW
P(+)terminal of tester(N(-)for digital tester)	UVW	P(+)	UVW	P(-)
Normal resistance	Several kΩ to several MΩ (*)			
Unacceptable resistance	Short (0 Ω) or open			



### 7.3.4 The IPM and outdoor PCB don't communicate or Related Abnormality

**outdoor display**    LED1 flash 4 times    Indoor Display F3

**Method of Malfunction Detection**    Communication is detected by checking the IPM module and the outdoor PCB

**Malfunction Decision Conditions**

- The outdoor PCB broken leads to communication fault
- The IPM module broken leads to communication fault

**Supposed Causes**

- The outdoor PCB is broken
- The IPM module is broken
- Communication wiring disconnected

**Troubleshooting**    \* **Caution** Be sure to turn off power switch before connect or disconnect connector, or else parts damage may be occurred.

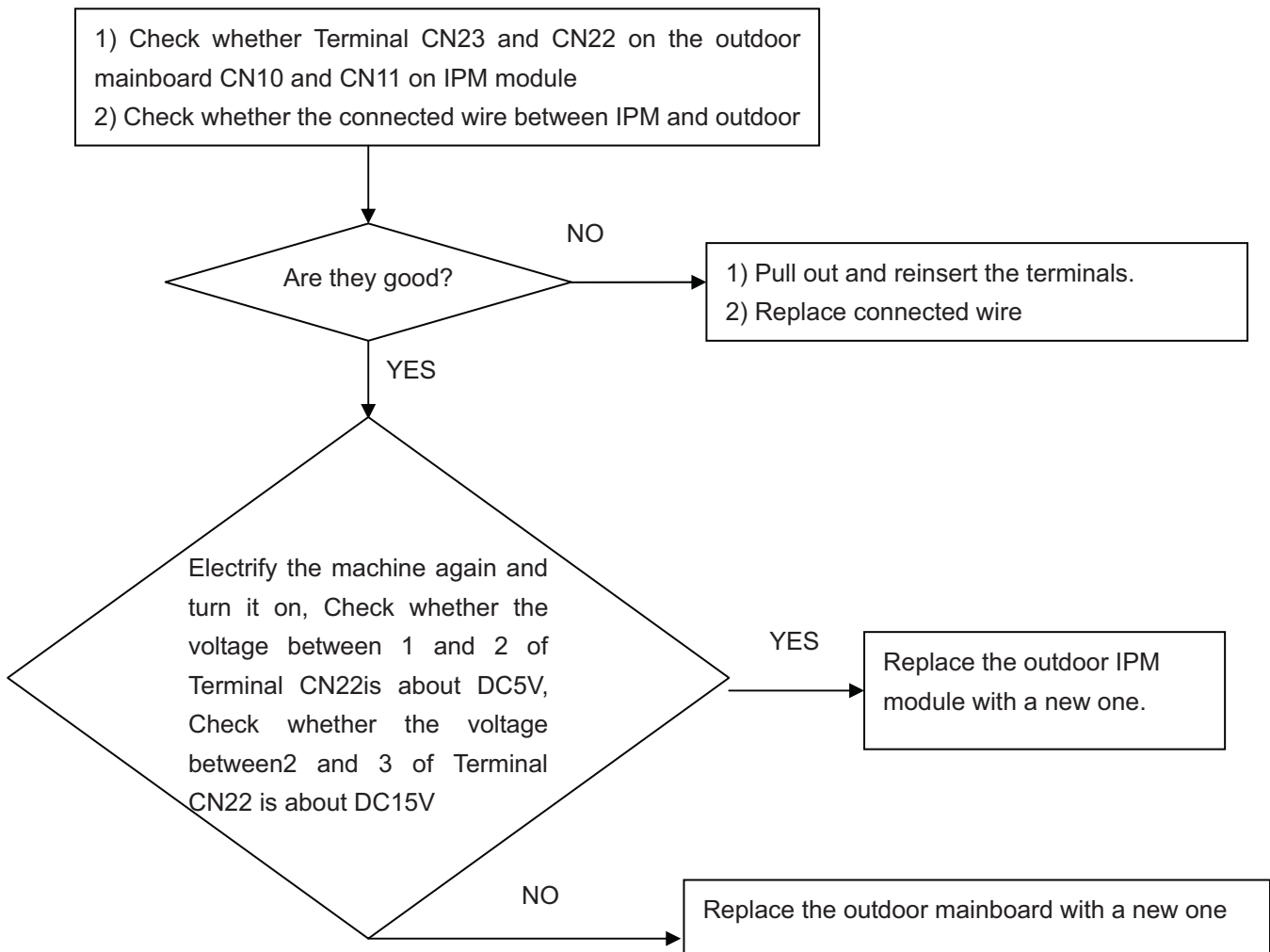

### 7.3.5 Thermistor or Related Abnormality(outdoor unit)

**Frost-removing temperature sensor failure**

**Indoor display:** F21  
**outdoor display:** LED1 flash 10 times:

**Exhaust temperature sensor failure**

**Indoor display:** F25  
**outdoor display:** LED1 flash 13 times:

**Ambient temperature sensor failure**

**Indoor display:** F6  
**outdoor display:** LED1 flash 12 times:

**Suck temperature sensor failure**

**Indoor display:** F7  
**outdoor display:** LED1 flash 11times:

**Method of Malfunction Detection** This type of error is detected by checking the thermistor input voltage to the microcomputer. (A thermistor error is detected by checking the temperature)

**Malfunction Decision Conditions** The thermistor input is above 4.9V or below 0.1V with the power on.  
 \* **Note:** The values may vary slightly in some models

- Supposed Causes**
- Faulty connector connection
  - Faulty thermistor
  - Faulty PCB

**Troubleshooting** \* **Caution** Be sure to turn off power switch before connect or disconnect connector, or else parts damage may be occurred.

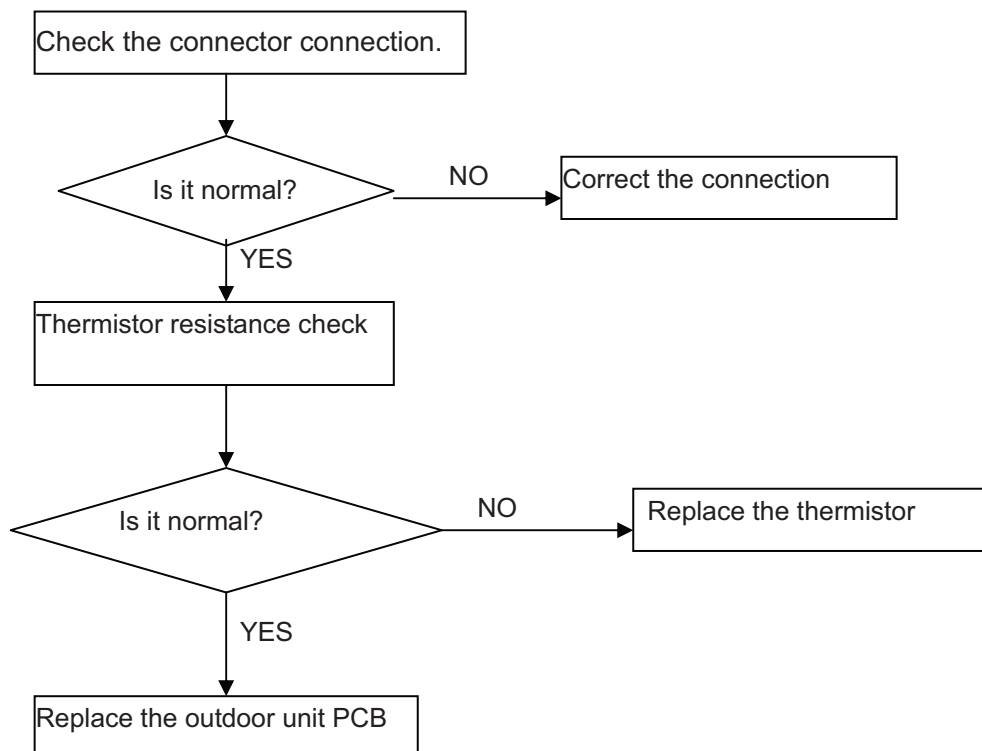

### 7.3.6 Overheat Protection For Exhaust Temperature

**Indoor display**  
**outdoor display**

**F4**  
LED1 flash 8 times

**Method of Malfunction Detection**

the exhaust temperature control is checked with the temperature being detected by the exhaust pipe thermistor

**Malfunction Decision Conditions**

when the compressor discharge temperature is above 117°C

**Supposed Causes**

- Electronic expansion valve defective
- Faulty thermistor
- Faulty PCB

**Troubleshooting**

**\* Caution** Be sure to turn off power switch before connect or disconnect connector, or else parts damage may be occurred.

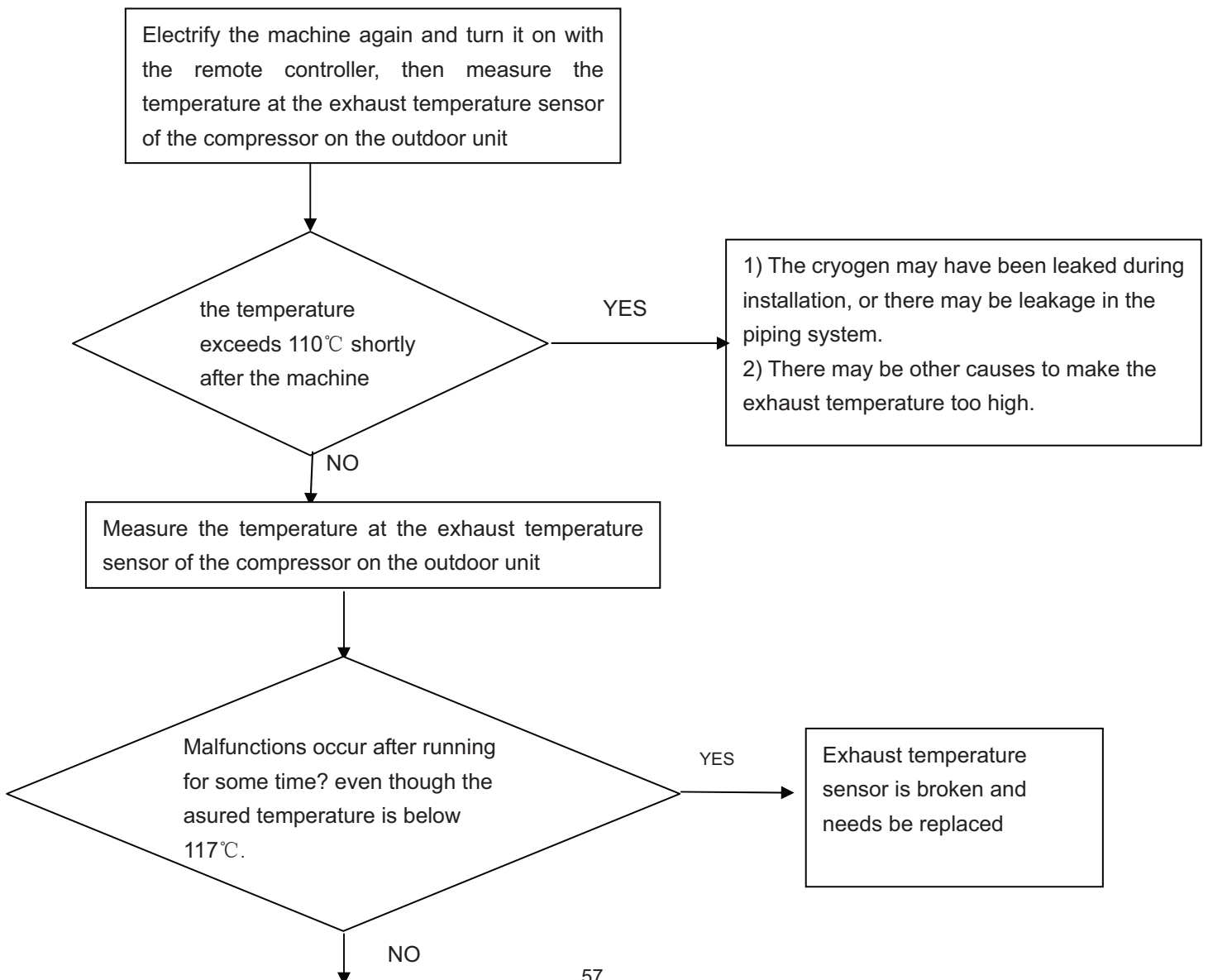

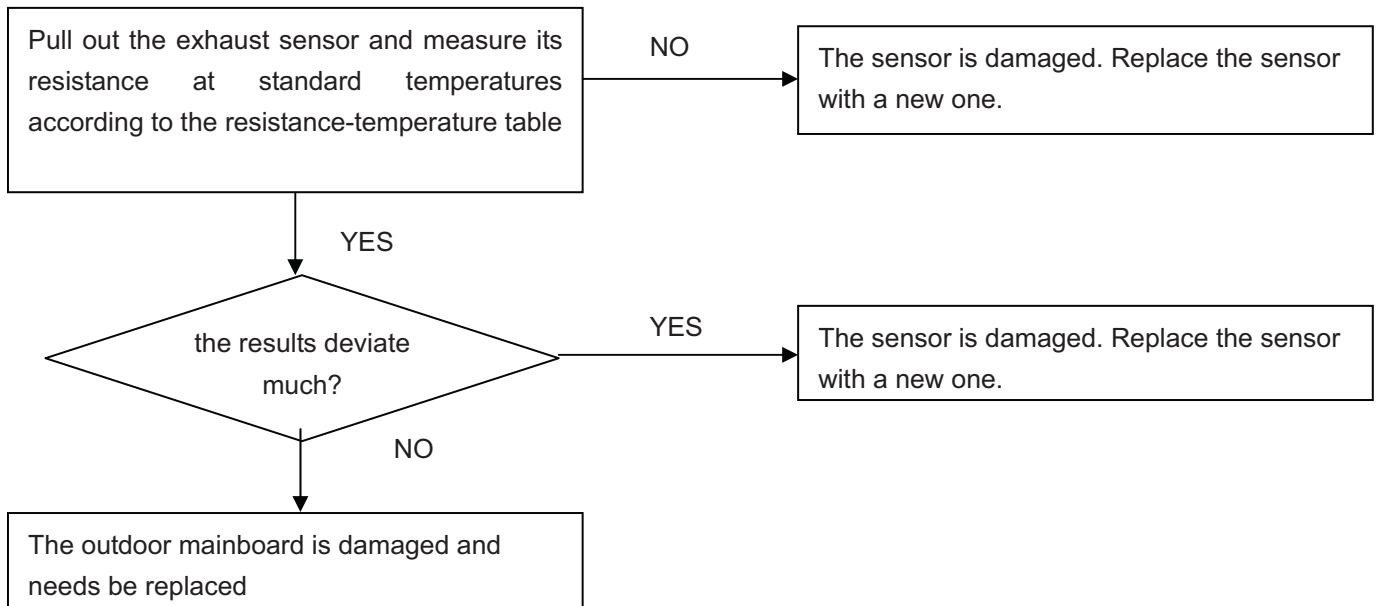

### 7.3.7 The EEPROM Abnormality (Indoor or outdoor unit)

**Indoor Display** E4: : Indoor EEPROM error  
F12: Outdoor EEPROM error

**Method of Malfunction Detection** the Data detected by the EEPROM are used to determine MCU

**Malfunction Decision Conditions** when the Data of EEPROM is error or the EEPROM is damaged

- Supposed Causes**
- Faulty EEPROM data
  - Faulty EEPROM
  - Faulty PCB

**Troubleshooting** \* **Caution** Be sure to turn off power switch before connect or disconnect connector, or parts damage may be occurred.

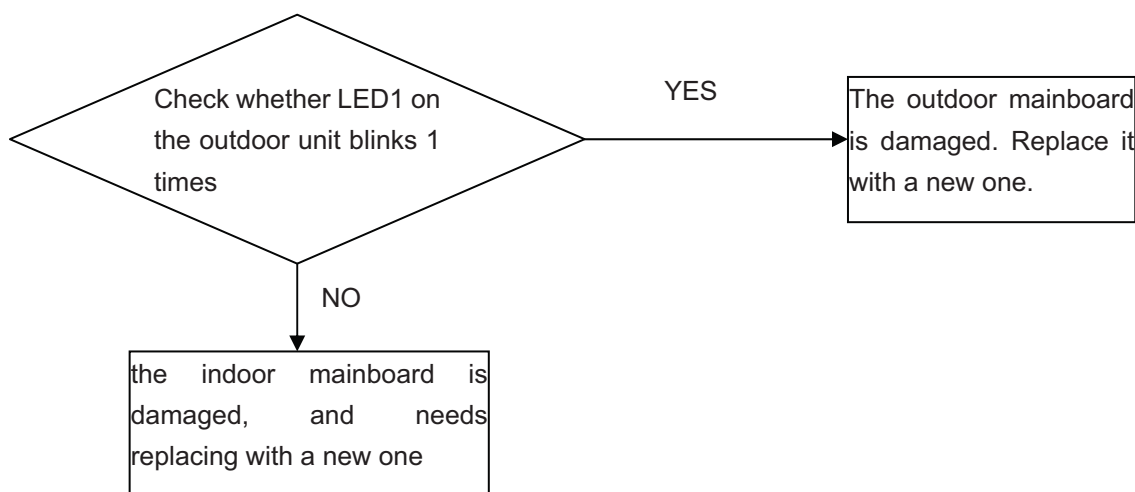



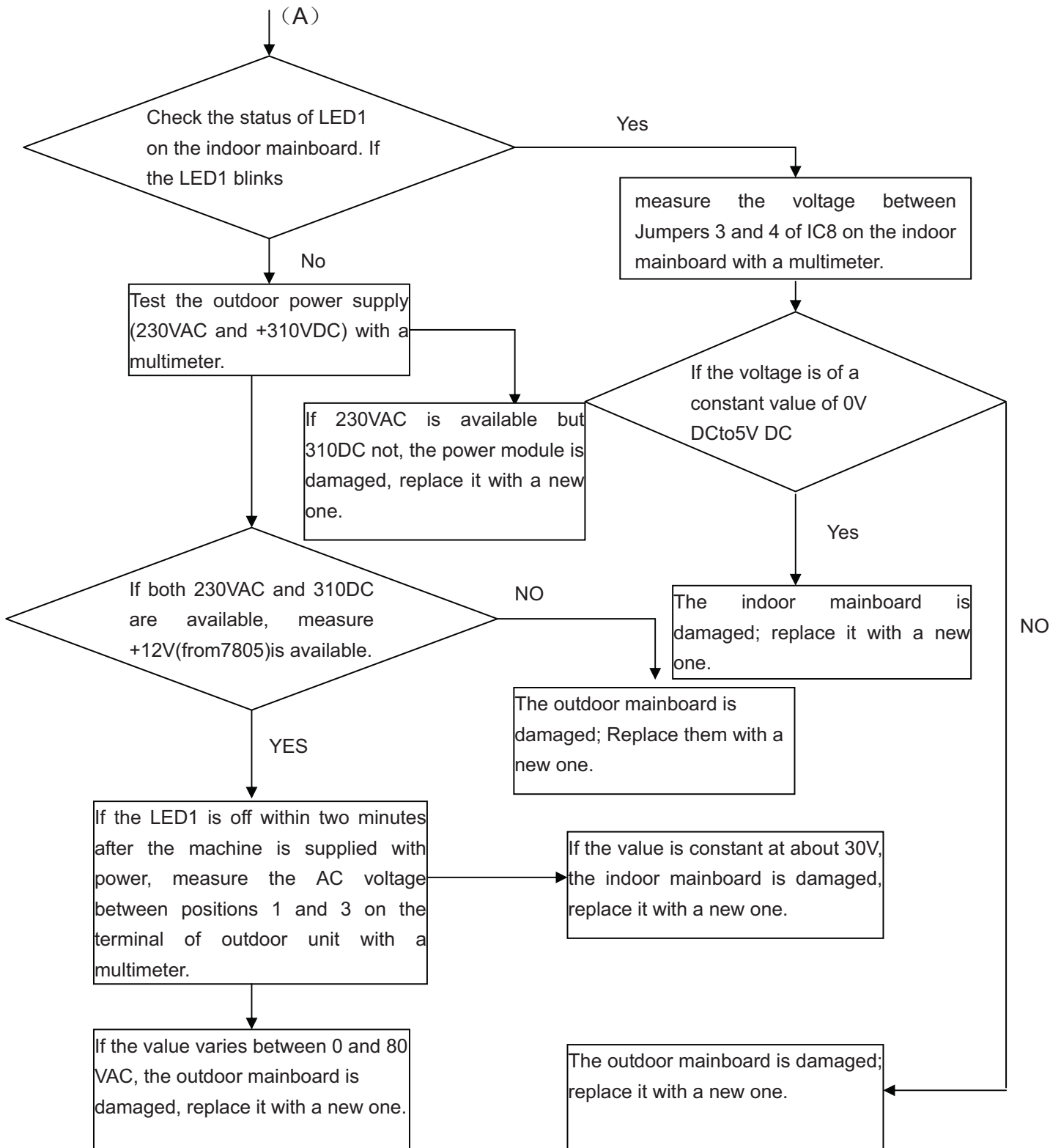

### 7.3.10 Power Supply Over or under voltage fault

<b>Indoor display</b>	<b>F19</b>
<b>outdoor display:</b>	LED1 flash 6 times
<b>Method of circuit.</b>	An abnormal voltage rise or fall is detected by checking the specified voltage detection
<b>Malfunction Detection</b>	
<b>Malfunction Decision Conditions</b>	An voltage signal is fed from the voltage detection circuit to the microcomputer
<b>Supposed Causes</b>	<ul style="list-style-type: none"> <li>■ Supply voltage not as specified</li> <li>■ the IPM module is broken</li> <li>■ the outdoor PCB is broken</li> </ul>
<b>Troubleshooting</b>	<p><b>* Caution</b> Be sure to turn off power switch before connect or disconnect connector, or else parts damage may be occurred.</p>

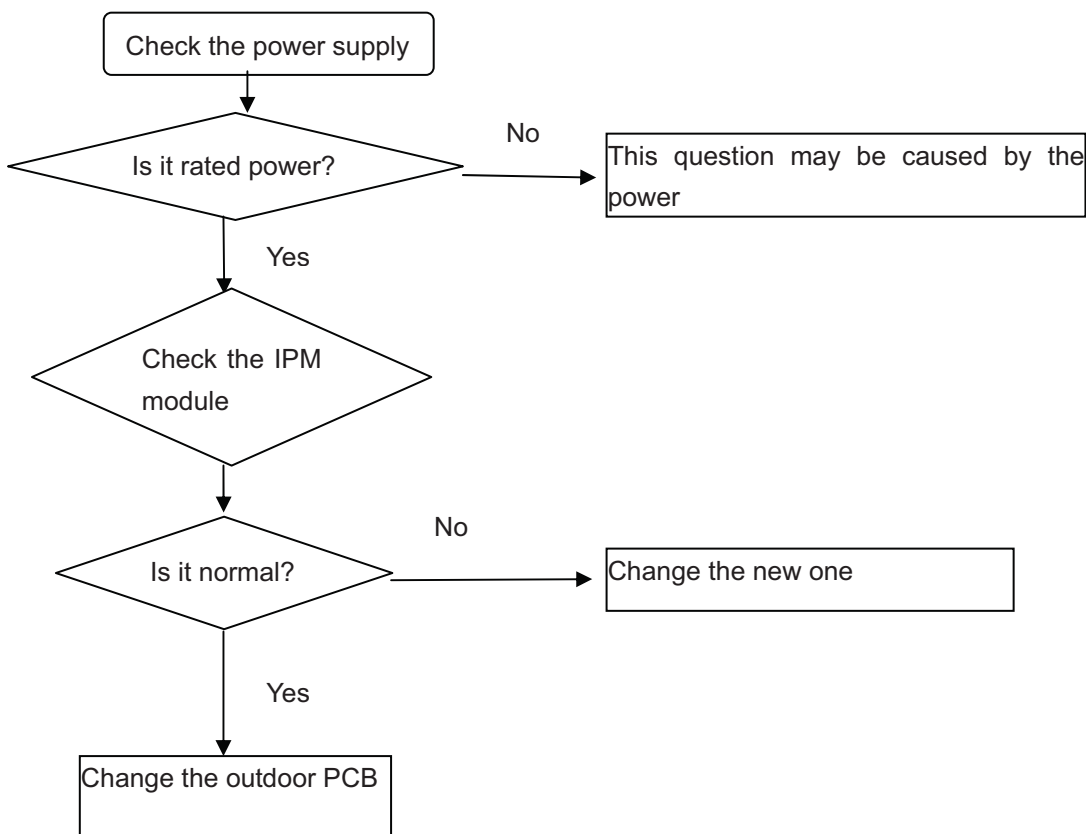

About how to check the IPM module, please refer to IPM protection fault

### 7.3.11 Loop of the station detect error

<b>Outdoor Display</b>	LED1 flash 18 times	<b>Indoor Display</b>	F11
	LED1 flash 19 times	<b>Indoor Display</b>	F28

**Method of Malfunction Detection** the position of the compressor rotor can not detected normally

**Malfunction Decision Conditions** when the The wiring of compressor is wrong or the connection is poor; or the compressor is damaged

- Supposed Causes**
- Faulty The wiring of compressor
  - Faulty compressor
  - Faulty PCB

**Troubleshooting** \* **Caution** Be sure to turn off power switch before connect or disconnect connector, or parts damage may be occurred.

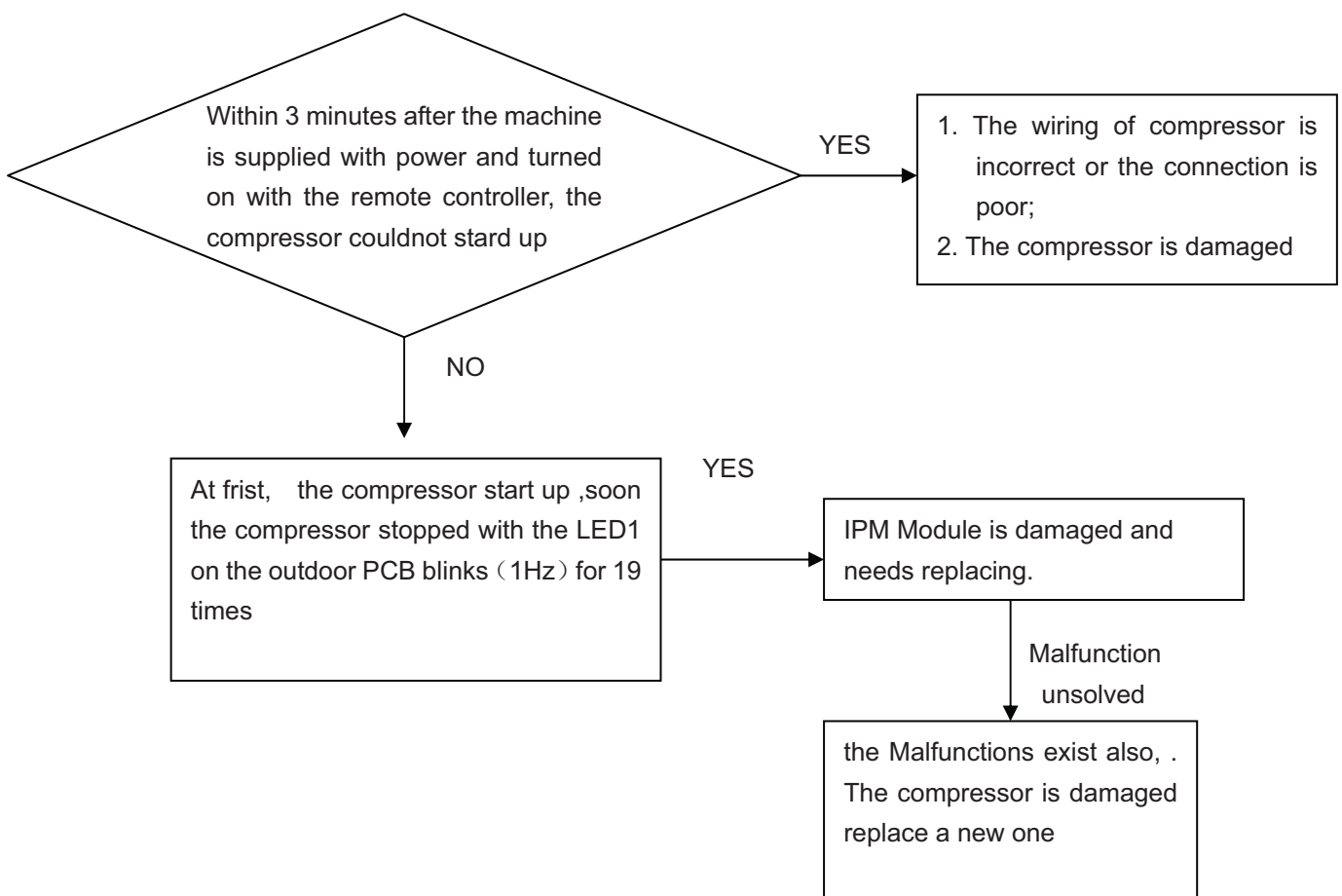



### 7.3.12 Over-current of the compressor

<b>Outdoor Display</b>	LED1 flash 3 or 24 or 25 times
<b>Method of Malfunction Detection</b>	The current of the compressor is too high
<b>Malfunction Decision Conditions</b>	when the IPM Module is damaged or the compressor is damaged power supply. voltage is too low or too high
<b>Supposed Causes</b>	<ul style="list-style-type: none"> <li>■ Faulty IPM Module</li> <li>■ Faulty compressor</li> <li>■ Faulty power supply</li> </ul>

**Troubleshooting** \* **Caution** Be sure to turn off power switch before connect or disconnect connector, or parts damage may be occurred.

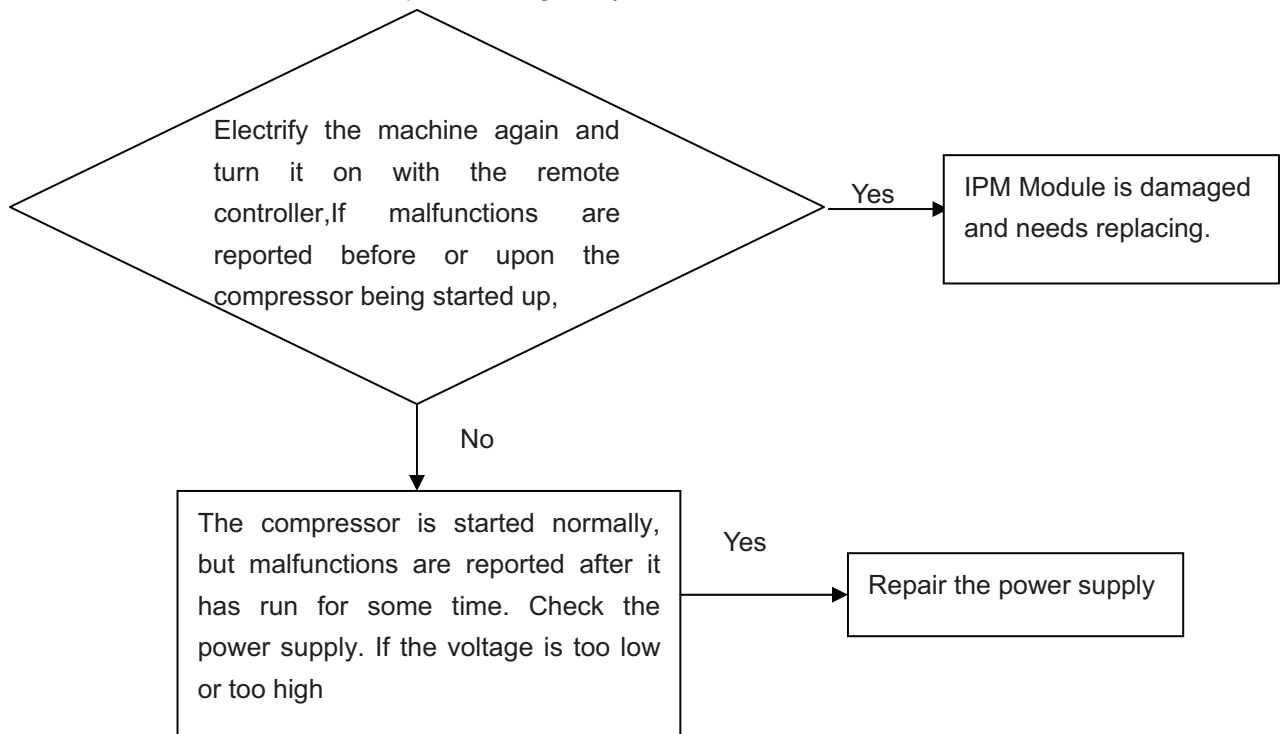

### 7.3.13 Fan Motor(DC Motor) or Related Abnormality

**Indoor Display** LED1 flash 9 times

**Method of determine Malfunction Detection** The rotation speed detected by the Hall IC during fan motor operation is used to abnormal fan motor operation

**Malfunction Decision Conditions** when the detected rotation feedback signal don't received in 2 minutes

**Supposed Causes**

- Operation halt due to short circuit inside the fan motor winding.
- Operation halt due to breaking of wire inside the fan motor .
- Operation halt due to breaking of the fan motor lead wires
- Dedection error due to faulty indoor unit PCB

#### How to check Fan Motor (DC)

1. Check connector connection.
2. Check motor power supply voltage output (pins 4-7).
3. Check motor control voltage (pins 4-3).
4. Check rotation command voltage output (pins 4-1).
5. Check rotation pulse input (pins 4-2).

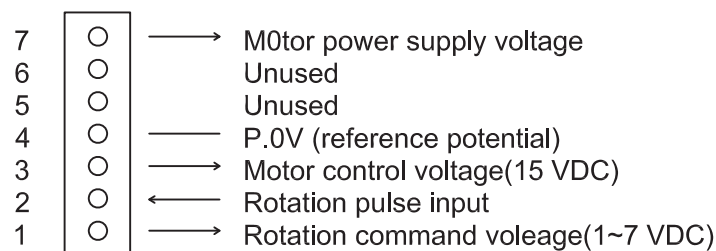

**Notes:**the a/c is electrifying,don't pull out or insert the terminals of the motor,else the motor would be damaged

**Troubleshooting** \* **Caution** Be sure to turn off power switch before connect or disconnect connector, or parts damage may be occurred.

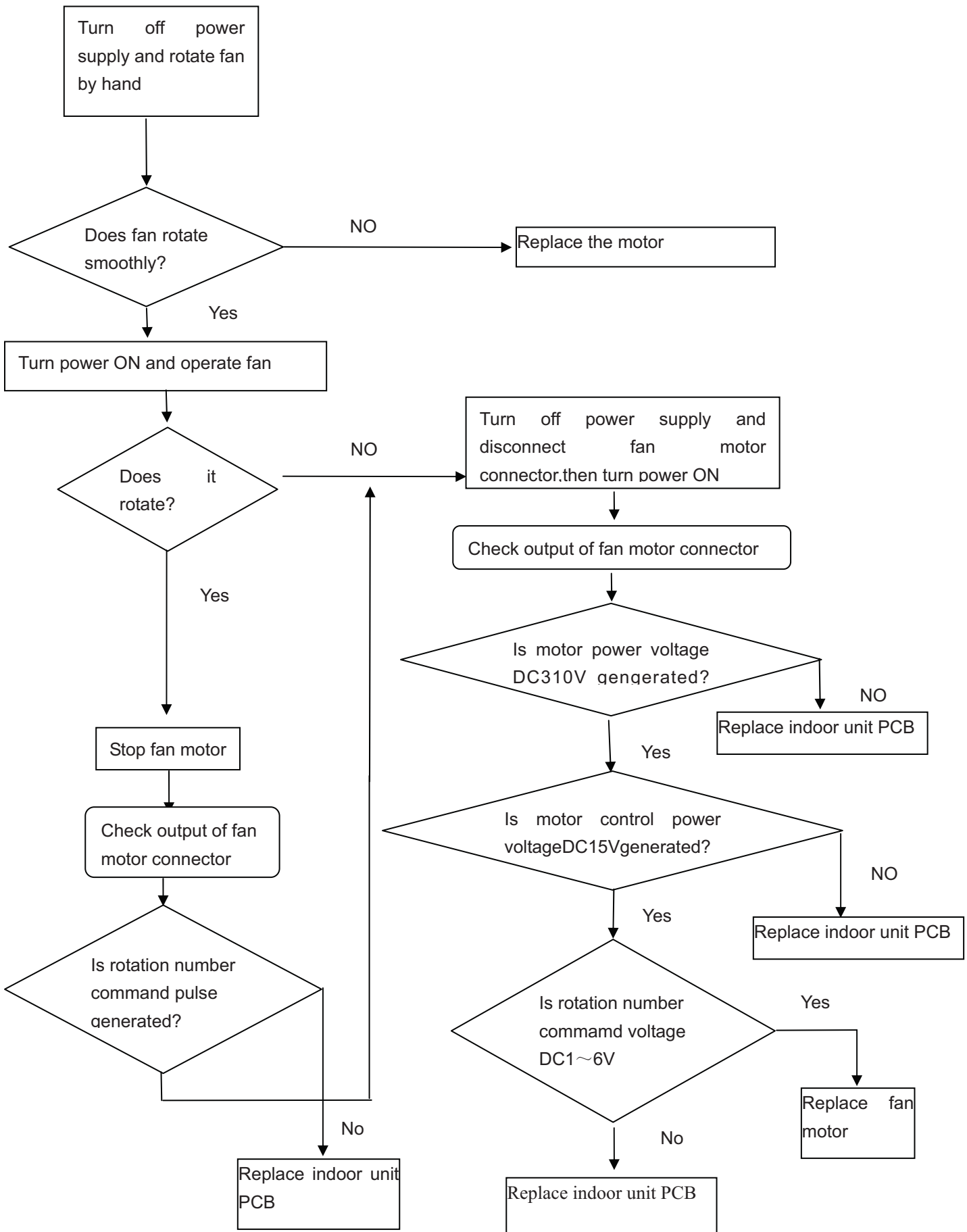

# 10.Wiring Diagrams

## 10.1.INDOORUNIT

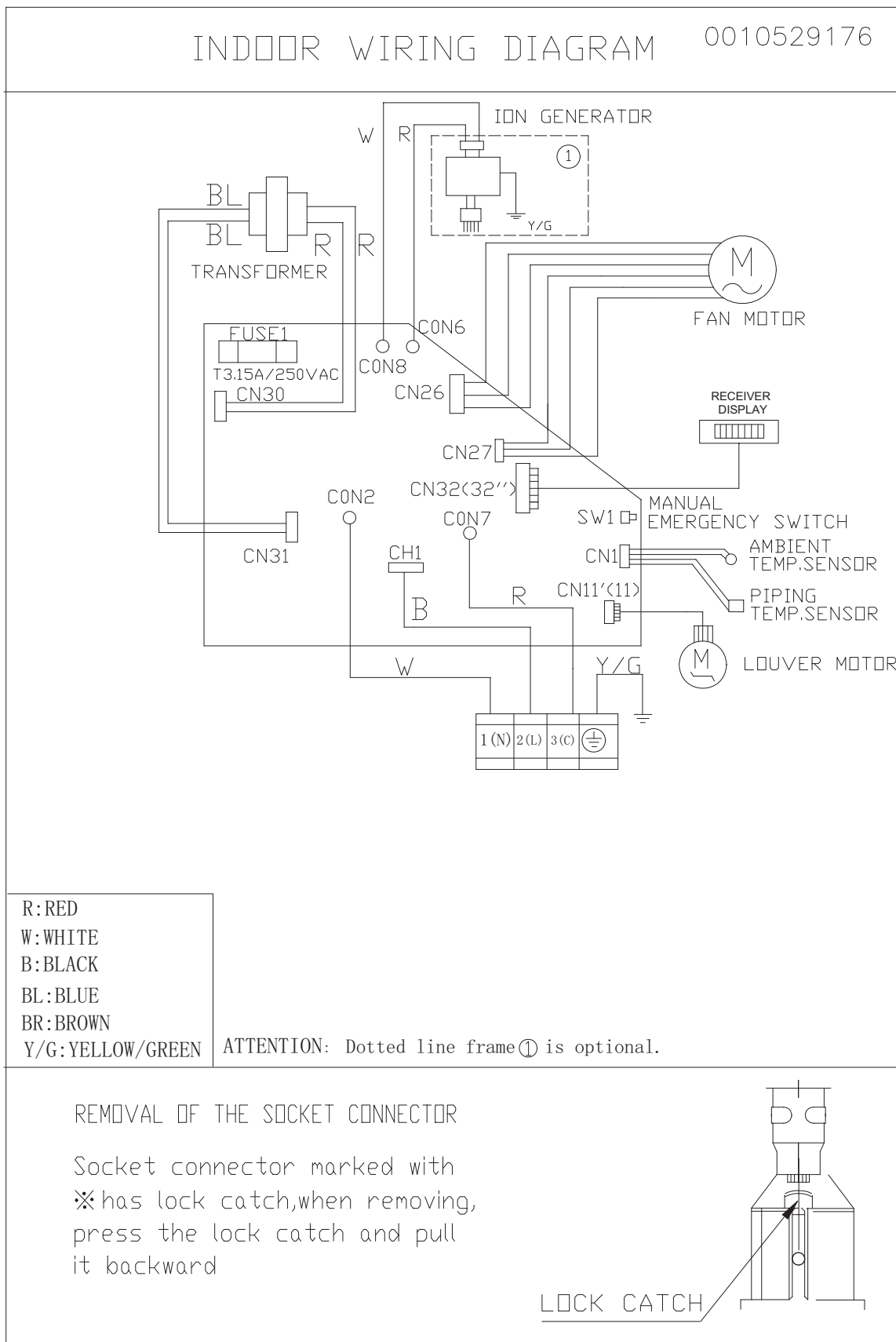

# 10.2.Outdoor unit

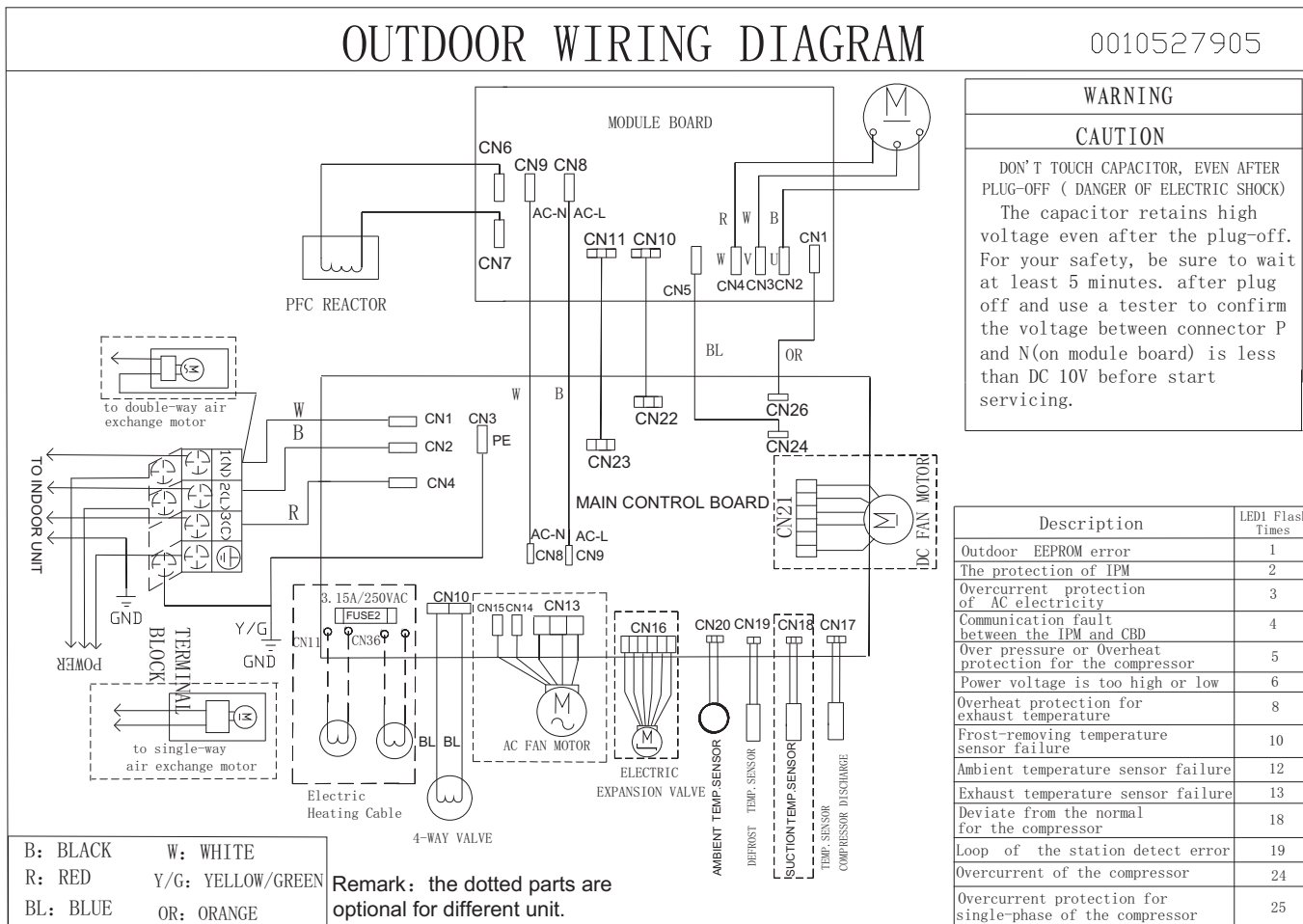

# 11.Circuit Diagrams

## 11.1.INDOORUNIT

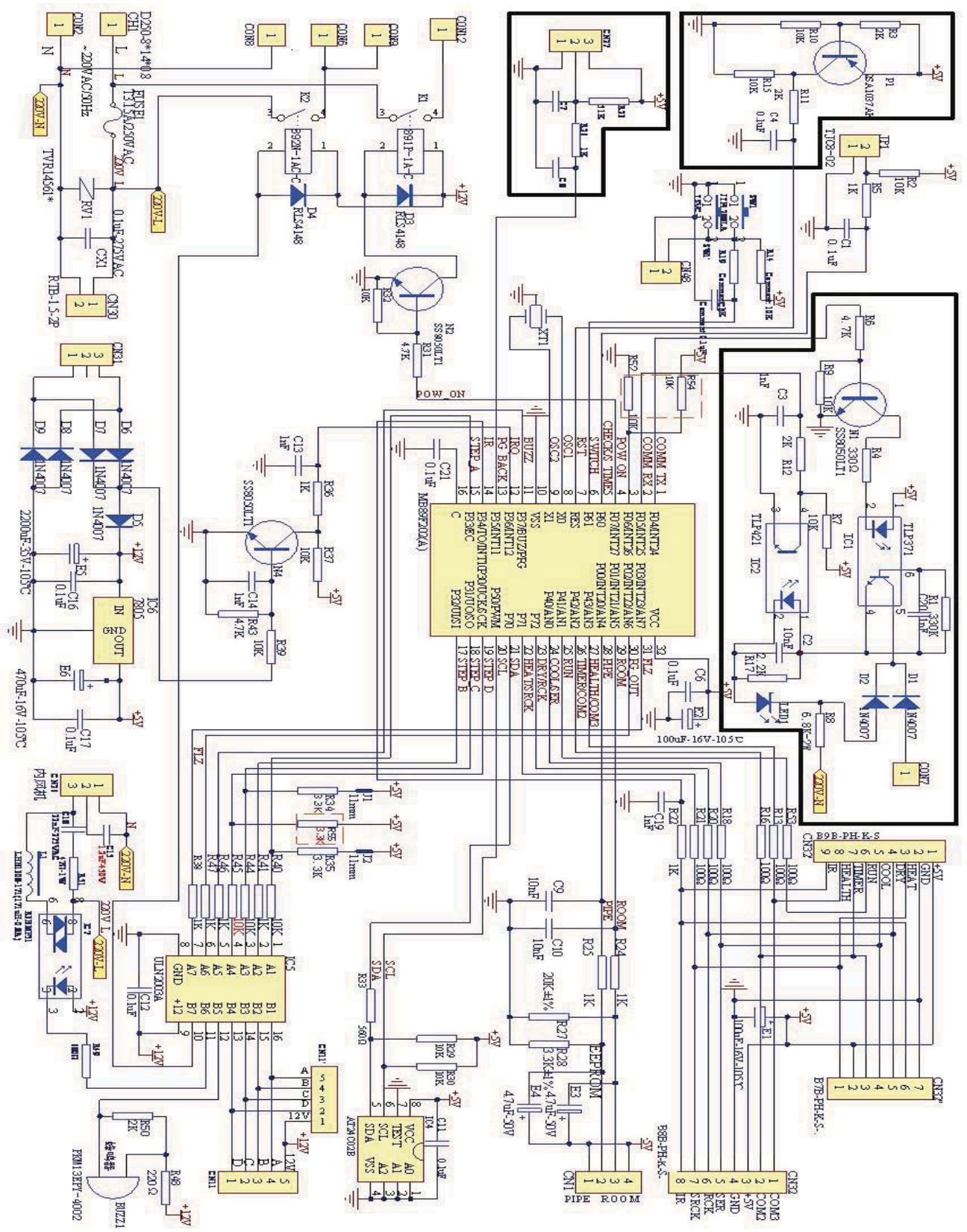

# 11.2.OUTDOORUNIT

## 11.2.1 module board Circuit Diagrams

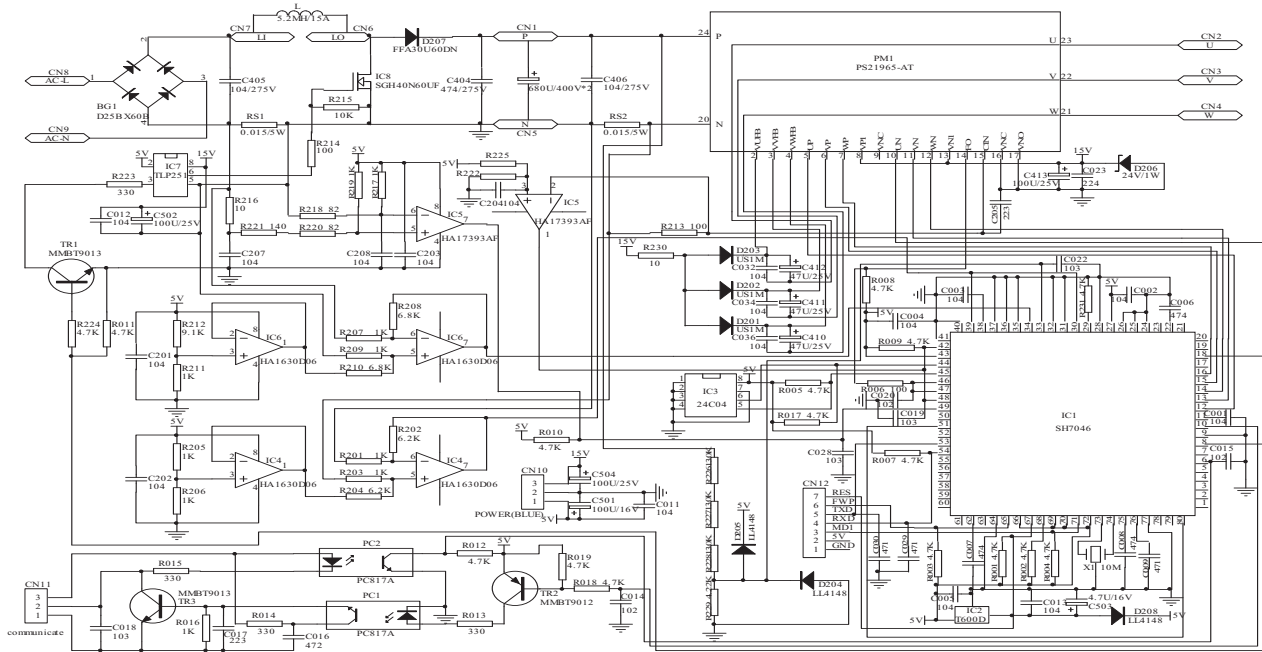

## 11.2.2 control board Circuit Diagrams

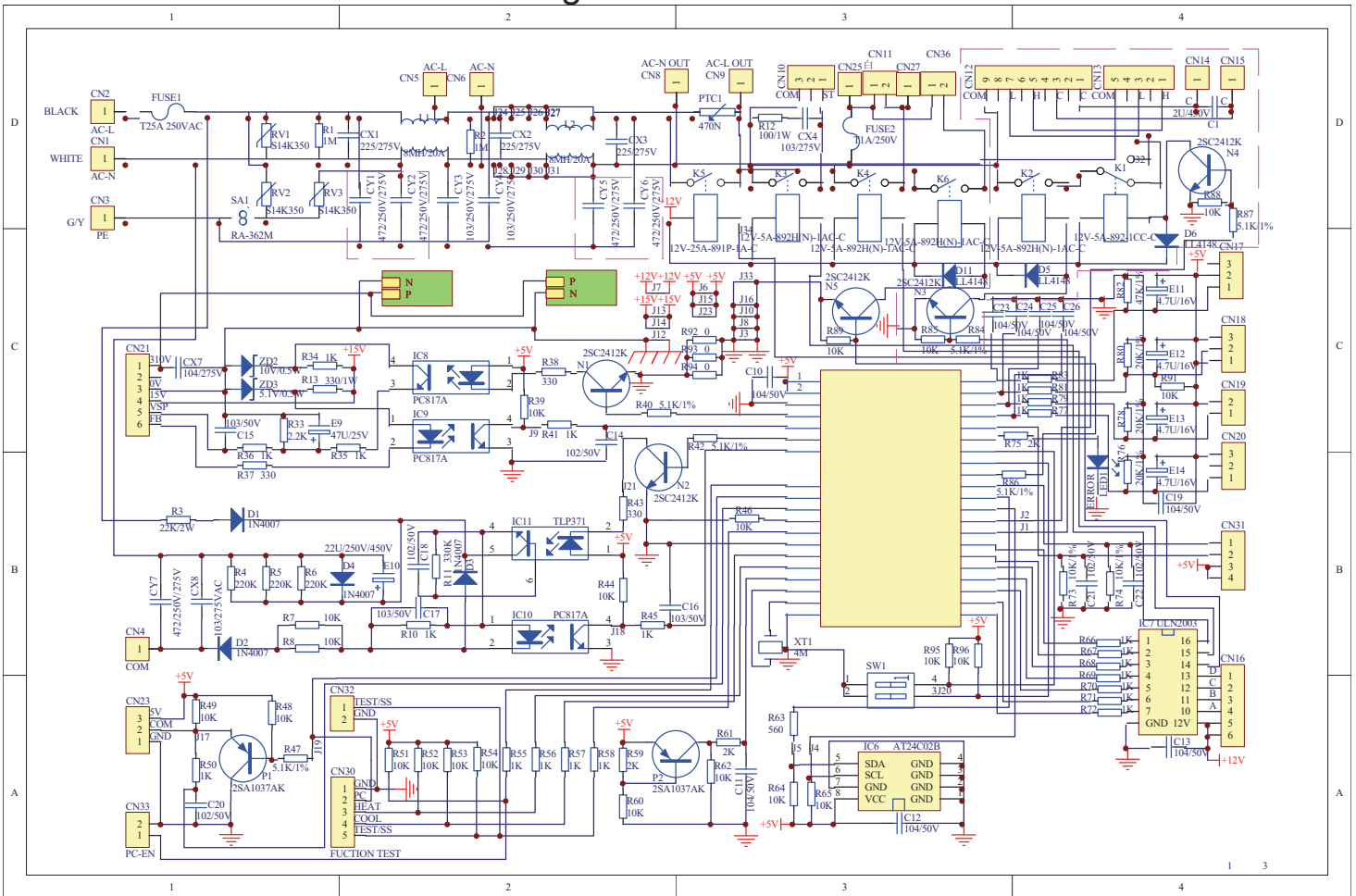

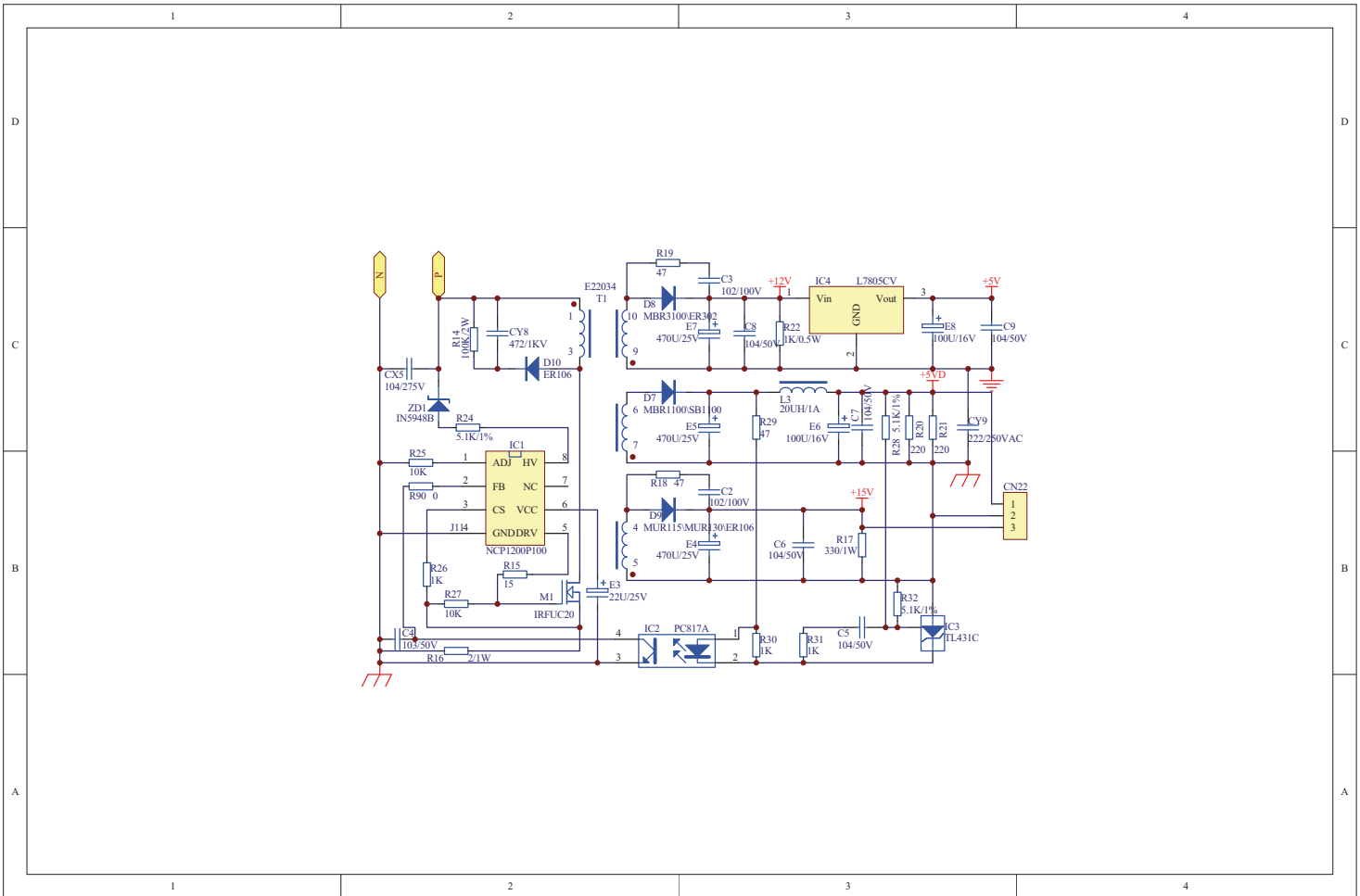



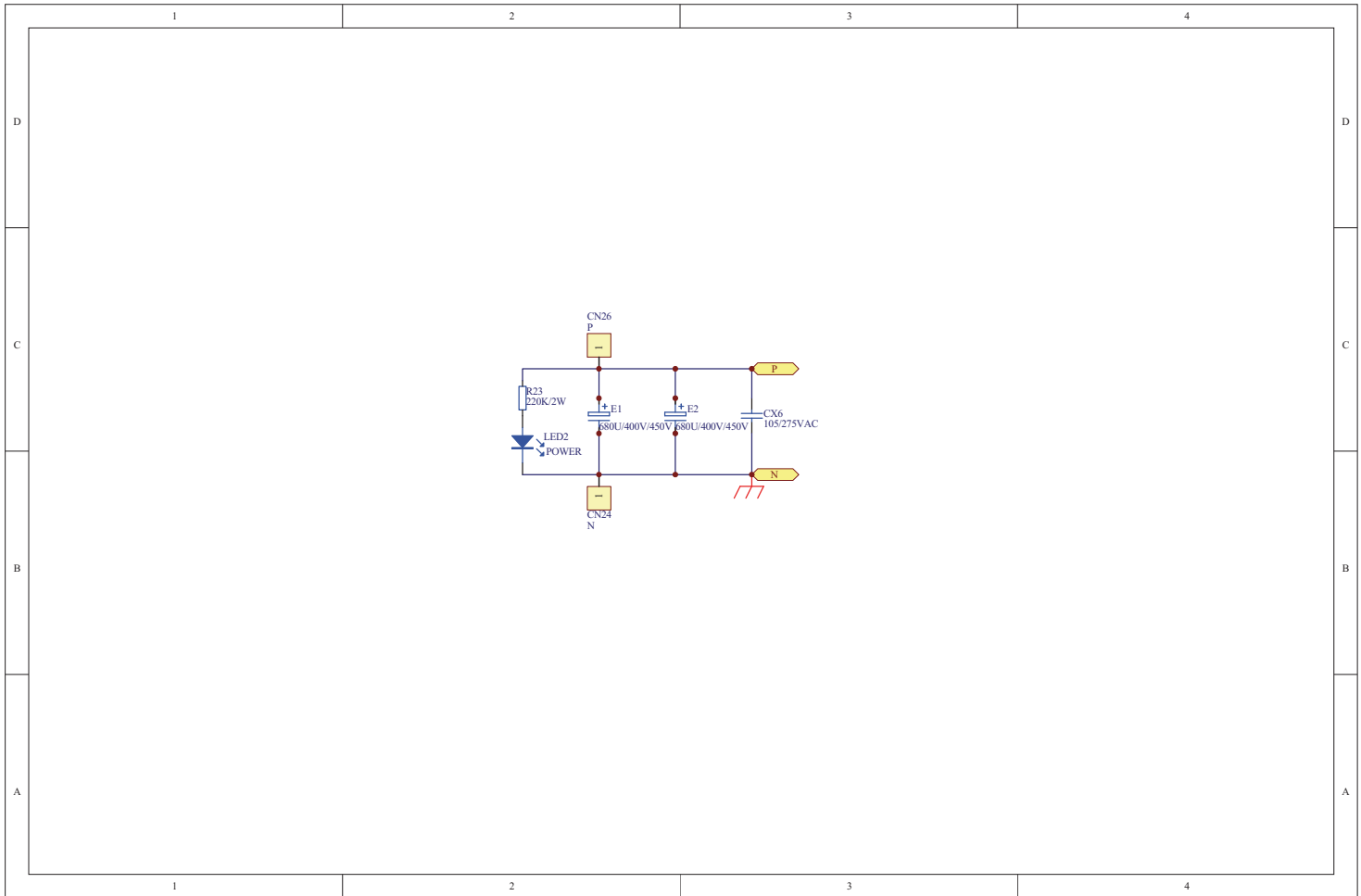

## 12. Description of coding rules of unit model

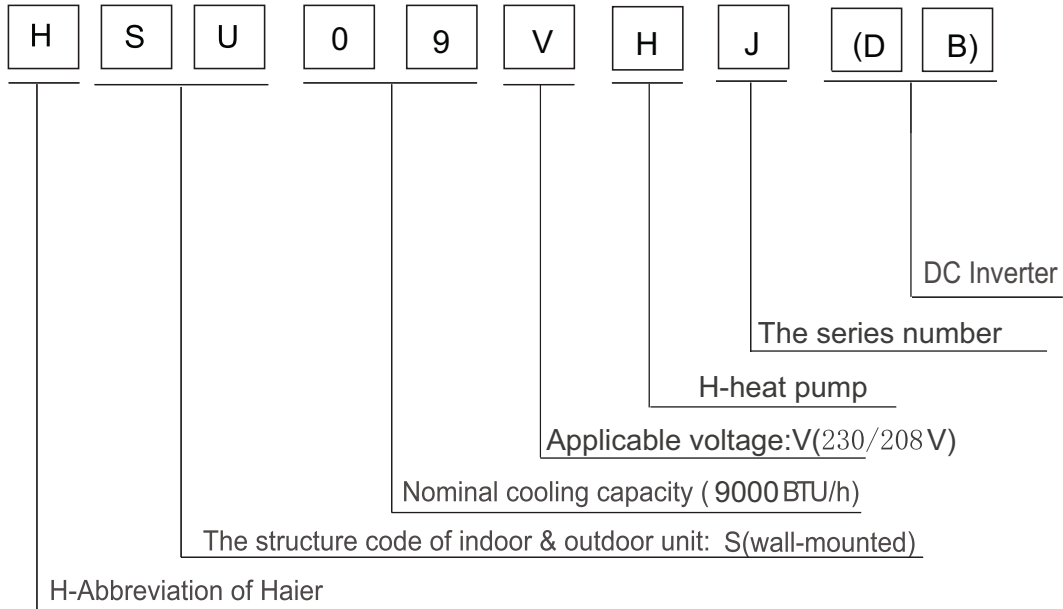

Examples:

HSU-07RD03/R1,It represents wall-mounted split type heat pump air conditioner .The cooling capacity is 7000BTU/h,and the power supply is 220-230V/50Hz,"D" means the developing sequence,and"R1" means the refrigerant is R407C.

# Sincere Forever

## Haier Group

---

Haier Industrial Park, No.1, Haier Road  
266101, Qingdao, China\_

E-mail: [hractech@haier.com](mailto:hractech@haier.com)

Tel: +86 532 88936935

[Http://www.haier.com](http://www.haier.com)

Edited by : Li Jingsheng  
Cui Xiaogao

Signed by : Yang Bifei

Approved by: W u Hongjin

# Haier

# SERVICE MANUAL

Order No.AC0910S008V0

## Wall mounted Type DC Inverter E-Series

### Model No. HSU12/18VHJ(DB)



12K



18K



12K



18K

### **WARNING**

This service information is designed for experienced repair technicians only and is not designed for use by the general public. It does not contain warnings or cautions to advise non-technical individuals of potential dangers in attempting to service a product. Products powered by electricity should be serviced or repaired only by experienced professional technicians. Any attempt to service or repair the product or products dealt with in this service information by anyone else could result in serious injury or death.

©2009 (Qingdao Haier Air Conditioner General corp.,Ltd)  
All right reserved .Unauthorized copying and distribution is a violation of law

## Haier Group

# Table of Contents

<b>1. Introduction</b> .....	1
<b>2. List of Functions</b> .....	6
<b>3. Specifications</b> .....	7
<b>4. Printed Circuit Board Connector Wiring Diagram</b> .....	9
<b>5. Functions and Control</b> .....	19
5.1 Main functions and control specifications of indoor unit .....	19
5.2 Main functions and control specifications of outdoor unit .....	25
5.3 Function of main thermistor .....	30
5.4 Value of thermistor .....	31
<b>6. System Configuration</b> .....	46
6.1 System Configuration.....	46
6.2 Instruction.....	46
<b>7. Service Diagnosis</b> .....	54
7.1 Caution for diagnosis.....	54
7.2 Problem Symptoms and Measures .....	54
7.3 Error codes and description indoor display .....	55
<b>8. Installations</b> .....	68
<b>9. Removal Procedure</b> .....	72
9.1 For 12K indoor unit .....	72
9.2 For 18K indoor unit.....	82
9.3 For 12/18K outdoor unit .....	91

**10. Appendix.....101**

10.1 Piping Diagrams.....101

10.2 Wiring Diagrams.....102

10.3 Circuit Diagrams.....106

# 1. Introduction

## 1.1 Safety Cautions

Be sure to read the following safety cautions before conducting repair work.

The caution items are classified into "Warning" and "Caution". The "Warning" items are especially important since they can lead to death or serious injury if they are not followed closely. The "Caution" items can also lead to serious accidents under some conditions if they are not followed. Therefore, be sure to observe all the safety caution items described below.

About the pictograms

△ This symbol indicates an item for which caution must be exercised.

The pictogram shows the item to which attention must be paid.

○ This symbol indicates a prohibited action.





The prohibited item or action is shown inside or near the symbol.







● This symbol indicates an action that must be taken, or an instruction.

The instruction is shown inside or near the symbol.

After the repair work is complete, be sure to conduct a test operation to ensure that the equipment operates normally, and explain the cautions for operating the product to the customer.

### 1.1.1 Caution in Repair



Warning	
<p>Be sure to disconnect the power cable plug from the plug socket before disassembling the equipment for a repair.</p> <p>Working on the equipment that is connected to a power supply can cause an electrical shock.</p> <p>If it is necessary to supply power to the equipment to conduct the repair or inspecting the circuits, do not touch any electrically charged sections of the equipment.</p>	
<p>If the refrigerant gas discharges during the repair work, do not touch the discharging refrigerant gas. The refrigerant gas can cause frostbite.</p>	
<p>When disconnecting the suction or discharge pipe of the compressor at the welded section, release the refrigerant gas completely at a well-ventilated place first.</p> <p>If there is a gas remaining inside the compressor, the refrigerant gas or refrigerating machine oil discharges when the pipe is disconnected, and it can cause injury.</p>	
<p>If the refrigerant gas leaks during the repair work, ventilate the area. The refrigerant gas can generate toxic gases when it contacts flames.</p>	
<p>The step-up capacitor supplies high-voltage electricity to the electrical components of the outdoor unit.</p> <p>Be sure to discharge the capacitor completely before conducting repair work. A charged capacitor can cause an electrical shock.</p>	
<p>Do not start or stop the air conditioner operation by plugging or unplugging the power cable plug.</p> <p>Plugging or unplugging the power cable plug to operate the equipment can cause an electrical shock or fire.</p>	

Warning	
Do not repair the electrical components with wet hands. Working on the equipment with wet hands can cause an electrical shock.	
Do not clean the air conditioner by splashing water. Washing the unit with water can cause an electrical shock.	
Be sure to provide the grounding when repairing the equipment in a humid or wet place, to avoid electrical shocks.	
Be sure to turn off the power switch and unplug the power cable when cleaning the equipment. The internal fan rotates at a high speed, and cause injury.	
Do not tilt the unit when removing it. The water inside the unit can spill and wet the furniture and floor.	
Be sure to check that the refrigerating cycle section has cooled down sufficiently before conducting repair work. Working on the unit when the refrigerating cycle section is hot can cause burns.	
Use the welder in a well-ventilated place. Using the welder in an enclosed room can cause oxygen deficiency.	

### 1.1.2 Cautions Regarding Products after Repair



Warning	
Be sure to use parts listed in the service parts list of the applicable model and appropriate tools to conduct repair work. Never attempt to modify the equipment. The use of inappropriate parts or tools can cause an electrical shock, excessive heat generation or fire.	
When relocating the equipment, make sure that the new installation site has sufficient strength to withstand the weight of the equipment. If the installation site does not have sufficient strength and if the installation work is not conducted securely, the equipment can fall and cause injury.	
Be sure to install the product correctly by using the provided standard installation frame. Incorrect use of the installation frame and improper installation can cause the equipment to fall, resulting in injury.	For integral units only
Be sure to install the product securely in the installation frame mounted on a window frame. If the unit is not securely mounted, it can fall and cause injury.	For integral units only





Warning	
<p>Be sure to use an exclusive power circuit for the equipment, and follow the technical standards related to the electrical equipment, the internal wiring regulations and the instruction manual for installation when conducting electrical work.</p> <p>Insufficient power circuit capacity and improper electrical work can cause an electrical shock or fire.</p>	
<p>Be sure to use the specified cable to connect between the indoor and outdoor units. Make the connections securely and route the cable properly so that there is no force pulling the cable at the connection terminals.</p> <p>Improper connections can cause excessive heat generation or fire.</p>	
<p>When connecting the cable between the indoor and outdoor units, make sure that the terminal cover does not lift off or dismount because of the cable.</p> <p>If the cover is not mounted properly, the terminal connection section can cause an electrical shock, excessive heat generation or fire.</p>	
<p>Do not damage or modify the power cable.</p> <p>Damaged or modified power cable can cause an electrical shock or fire. Placing heavy items on the power cable, and heating or pulling the power cable can damage the cable.</p>	
<p>Do not mix air or gas other than the specified refrigerant (R-410A / R22) in the refrigerant system.</p> <p>If air enters the refrigerating system, an excessively high pressure results, causing equipment damage and injury.</p>	
<p>If the refrigerant gas leaks, be sure to locate the leak and repair it before charging the refrigerant. After charging refrigerant, make sure that there is no refrigerant leak.</p> <p>If the leak cannot be located and the repair work must be stopped, be sure to perform pump-down and close the service valve, to prevent the refrigerant gas from leaking into the room. The refrigerant gas itself is harmless, but it can generate toxic gases when it contacts flames, such as fan and other heaters, stoves and ranges.</p>	
<p>When replacing the coin battery in the remote controller, be sure to disposed of the old battery to prevent children from swallowing it.</p> <p>If a child swallows the coin battery, see a doctor immediately.</p>	

Caution	
<p>Installation of a leakage breaker is necessary in some cases depending on the conditions of the installation site, to prevent electrical shocks.</p>	
<p>Do not install the equipment in a place where there is a possibility of combustible gas leaks.</p> <p>If a combustible gas leaks and remains around the unit, it can cause a fire.</p>	
<p>Be sure to install the packing and seal on the installation frame properly. If the packing and seal are not installed properly, water can enter the room and wet the furniture and floor.</p>	For integral units only

### 1.1.3 Inspection after Repair

Warning	
<p>Check to make sure that the power cable plug is not dirty or loose, then insert the plug into a power outlet all the way.</p> <p>If the plug has dust or loose connection, it can cause an electrical shock or fire.</p>	
<p>If the power cable and lead wires have scratches or deteriorated, be sure to replace them.</p> <p>Damaged cable and wires can cause an electrical shock, excessive heat generation or fire.</p>	





Warning	
<p>Do not use a joined power cable or extension cable, or share the same power outlet with other electrical appliances, since it can cause an electrical shock, excessive heat generation or fire.</p>	

Caution	
<p>Check to see if the parts and wires are mounted and connected properly, and if the connections at the soldered or crimped terminals are secure. Improper installation and connections can cause excessive heat generation, fire or an electrical shock.</p>	
<p>If the installation platform or frame has corroded, replace it. Corroded installation platform or frame can cause the unit to fall, resulting in injury.</p>	
<p>Check the grounding, and repair it if the equipment is not properly grounded. Improper grounding can cause an electrical shock.</p>	
<p>Be sure to measure the insulation resistance after the repair, and make sure that the resistance is 1 M ohm or higher.</p> <p>Faulty insulation can cause an electrical shock.</p>	
<p>Be sure to check the drainage of the indoor unit after the repair.</p> <p>Faulty drainage can cause the water to enter the room and wet the furniture and floor.</p>	

## 1.1.4 Using Icons

Icons are used to attract the attention of the reader to specific information. The meaning of each icon is described in the table below:

## 1.1.5 Using Icons List

Icon	Type of Information	Description
 Note:	Note	A "note" provides information that is not indispensable, but may nevertheless be valuable to the reader, such as tips and tricks.
 Caution	Caution	A "caution" is used when there is danger that the reader, through incorrect manipulation, may damage equipment, lose data, get an unexpected result or has to restart (part of) a procedure.
 Warning	Warning	A "warning" is used when there is danger of personal injury.
	Reference	A "reference" guides the reader to other places in this binder or in this manual, where he/she will find additional information on a specific topic.

## 2. List of Functions

Category	Functions	HSU12VHJ(DB)	HSU18VHJ(DB)
Healthy negative ion	make your room full of an abundance natural negative ions.	Y	Y
Left&right flow	With specialized motor and flaps, the airflow can be adjusted .	N	N
Child lock	Avoid the child's wrong operation on the remote controller	Y	Y
3D air flow	The 3D airflow is able to deliver the airflow horizontally and vertically.	N	N
24Hour timer	Use the timer function to set on,or off,or from on to off,or from off to on	Y	Y
Auto restart	automatic return to previous operation conditions after asudden power blackout	Y	Y
Easy clean design	The panel is easy to wash and the airflow vents can be detached easily	Y	Y
Intelligent air	With single-blade technology ,the airflow can be adjusted not to blow directly	Y	Y
Anti-mold filter	Catches most small particles and remove unpleasant odors effectively.	Y	Y
Sleep mode	The setting temprature and the indoor noise can be adjusted to a more comfortable level when you set the "sleep mode"during night sleep	Y	Y
4 Fan setting	Select the fan speed LO,MED,HI,AUTO	Y	Y
Entire auto mode	You can set a temprature value,with which the unit can be adjusted the operation mode automatically	Y	Y
Auto mode	adjust the last fixed operation mode automatically.	N	N
ESF filter	Trap harmful dust and remove unpleasant odors effectively	N	N
Power mode	Quick cooling or heating	Y	Y
Soft mode	lower noise operation condition	Y	Y
Negative ion filter	Generate negative ions by the filter.	N	N
Constant temperature dehumidification	Make dehumidifying in the room while keeping the constant temperature inside	N	N

Note: Y: Holding Functions

N : No Functions

### 3. Specifications

Model			HSU12VHJ(DB)		HSU18VHJ(DB)	
			Cooling	Heating	Cooling	Heating
Capacity Rated (Min.~Max.)	kW		3.51(0.88-3.95)	3.95(0.88-4.25)	5.27(1.17-5.57)	5.57(1.17-6.00)
	Btu/h		12000(3000-13500)	13500(3000-14500)	18000(4000-19000)	19000(4000-20500)
	kcal/h		3018.6(756.8-3397)	3397(756.8-3655)	4532.2(1006.2-4790.2)	4790.2(1006.2-5160)
Moisture Removal	pints/hr		2.82	—	3.52	—
Running Current (Rated)	A		5.4	5.9	8.0	7.8
Power Consumption Rated (Min.~Max.)	W		1090(250-1450)	1190(250-1450)	1640(270-1900)	1650(270-1950)
Power Factor	%		98	98	98	98
SEER/HSPF			16	9.5	16	9
Piping Connections	Liquid	inches	φ 1/4		φ 1/4	
	Gas	inches	φ 3/8		φ 1/2	
	Drain	inches	φ 5/8		φ 5/8	
Heat Insulation			Both Liquid and Gas Pipes		Both Liquid and Gas Pipes	
Max. Interunit Piping Length	feet		49 1/5		82 1/50	
Max. Interunit Height Difference	feet		32 4/5		49 1/5	
Chargeless	feet		32 4/5		32 4/5	
Amount of Additional Charge of Refrigerant	OZ/Inches		0.018		0.018	
Indoor Unit						
Front Panel Color			White		White	
Air Flow Rate	m <sup>3</sup> /min(cfm)	H	8	8	9	9
		M	7.2	7.2	8.2	8.2
		L	6.3	6.3	7.3	7.3
		SL	4.8	4.8	5.8	5.8
Fan	Type		Cross Flow Fan		Cross Flow Fan	
	Motor Output	W	16		16	
	Speed	Steps	4 Steps, Auto		4 Steps, Auto	
Air Direction Control			Horizontal, Downward		Horizontal, Downward	
Air Filter			Removable / Washable / Mildew Proof		Removable / Washable / Mildew Proof	
Running Current (Rated)	A		0.15	0.15	0.15	0.15
Power Consumption (Rated)	W		33	33	33	33
Temperature Control			Microcomputer Control		Microcomputer Control	
Dimensions (H×W×D)	inches		36 13/14 x 7 1/6 x 10 3/7		41 1/6 x 9 2/5 x 11 3/4	
Packaged Dimensions (H×W×D)	inches		39 7/8 x 10 5/6 x 13		45 x 14 4/9 x 12 21/23	
Weight	lbs		24		32	
Gross Weight	lbs		27.8		36.4	
Operation Sound	H/M/L	dBA	45/42/38	45/42/38	45/42/40	45/42/40
Sound Power	H	dBA	53	53	53	53

Outdoor Unit					
Casing Color		White		White	
Compressor	Type	Rotary Compressor		Rotary Compressor	
	Model	DA89X1C-20FZ		SNB130FGYM2	
	Motor Output	W	650	900	
RefrigerantOil	Model	ESTER OIL VG74		FV50S	
	Charge	pints	0.65	0.88	
Refrigerant	Model	R410a		R410a	
	Charge	oz	35.27	42.33	
Air Flow Rate (H/L)	m <sup>3</sup> /min	31.6	31.6	31.6	31.6
	cfm	1115	1115	1115	1115
Fan	Type	Propeller		Propeller	
	Motor Output	W	80	80	
Running Current (Rated)	A	3.5	3.5	4.9	4.8
Power Consumption (Rated)	W	780	780	1090	1050
Power Factor	%	98	98	98	98
Starting Current	A	20		26	
Dimensions (H×W×D)	inches	21 3/8 x 30 5/6 x 10 2/51		25 1/3 x 30 5/6 x10 2/51	
Packaged Dimensions (H×W×D)	inches	24 1/6 X 36 3/5 X 13 2/5		28 1/9 X 36 3/5 X 13 27/70	
Weight	lbs	72.8		88.2	
Gross Weight	lbs	79.4		97	
OperationSound	H/L	dBA	53	49	53
Sound Power	H	dBA	63	59	63

Note: The data are based on the conditions shown in the table below.

Cooling	Heating	Piping Length
Indoor ; <b>80° FDB/67° FWB</b> Outdoor ; <b>95° FDB/75° FWB</b>	Indoor ; <b>70° FDB/60° FWB</b> Outdoor ; <b>47° FDB/47° FWB</b>	16 2/5 feet

Conversion Formulae
kcal/h=kW×860
Btu/h=kW×3414
cfm=m <sup>3</sup> /min×35.3

## 4. Printed Circuit Board Connector Wiring Diagram

### 4.1 : Indoor unit Connectors

FOR 12K

#### Connectors

##### PCB(1) (Control PCB)

- 1) CN26 Connector for fan motor
- 2) CN11 Connector for STEP motor
- 3) CN8 Connector for heat exchanger thermistor and Room temperature thermistor
- 4) CN27 Connector for fan feedback
- 5) CH1 Connector for power L wire
- 6) CON2 Connector for power N wire
- 7) CON7 Connector for communicate wire
- 8) CN30 Connector for transformer input
- 9) CN31 Connector for transformer output
- 10) CN32 Connector for display board

#### Note: Other designations

PCB(1) (INdoor Control PCB)

- 1) CN48 Connector for Forced operation ON / OFF switch
- 2) J1 Select 25 or 35
- 3) LED1 communicate display light
- 4) RV1 Varistor
- 5) FUSE1 Fuse 3.15A/250VAC

PCB(1)

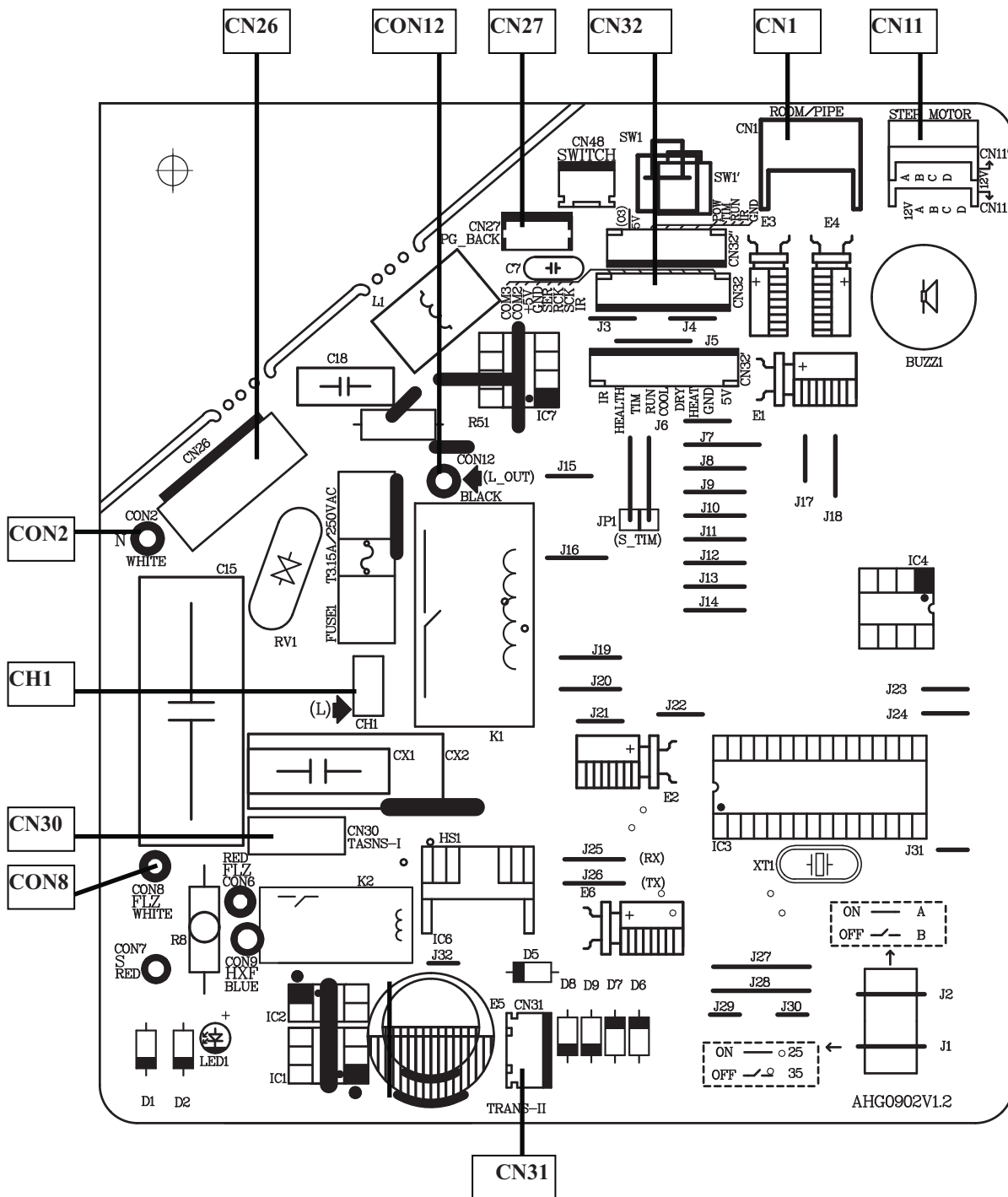



**FOR 18K****Connectors****PCB(1) (Control PCB)**

- 1) CN26 Connector for fan motor
- 2) CN1 Connector for heat exchanger thermistor and Room temperature thermistor
- 3) CN11 Connector for UP&DOWN STEP motor
- 4) CON2 Connector for power N wire
- 5) CON1 Connector for power L
- 6) CN32 Connector for display board
- 7) C0N6 C0N8 Connector for ions generator
- 8) C0N7 Connector for communicate between the indoor board and the outdoor board

**Note: Other designations**

## PCB(1) (INdoor Control PCB)

- 1) CN48 Connector for Forced operation ON / OFF switch
- 2) J1 Select 25 or 35
- 3) LED1 communicate display light
- 4) RV1 Varistor
- 5) FUSE1 Fuse 3.15A/250VAC

# PCB(1)

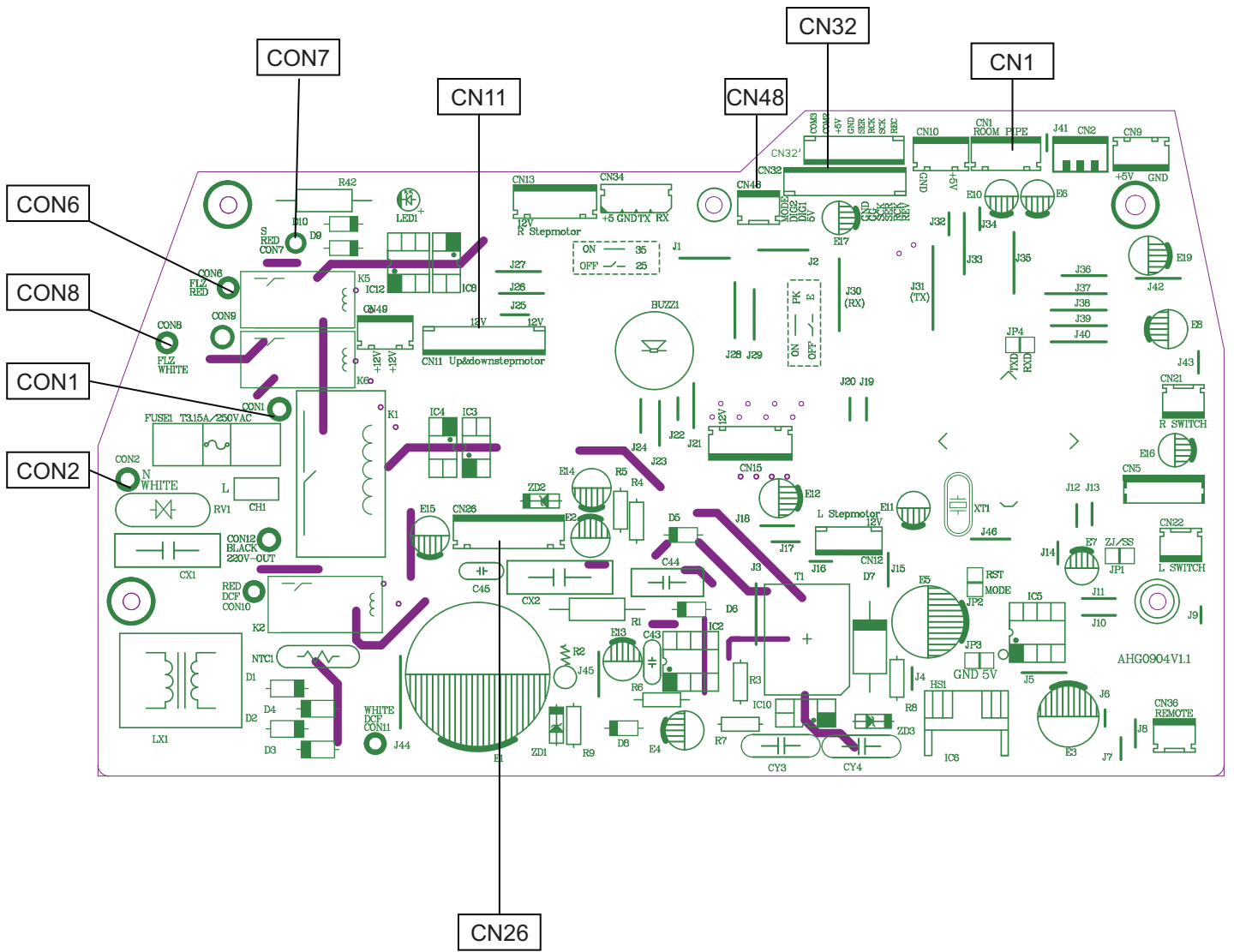

## 4.2 : Outdoor unit

### FOR12K

#### Connectors

##### PCB(1) (Control PCB)

- 1) CN1 CN2 Connector for power N and L
- 2) CN3 Connector for ground
- 3) CN22 Connector for DC POWER 15V and 5V to the module board
- 4) CN16 Connector for electric expansion valves
- 5) CN21 Connector for DC fan motor
- 6) CN10 Connector for four way valve coil
- 7) CN17 CN18 CN19 CN20 Connector for thermistors  
(CN20: outdoor air CN19: heat exchanger CN18 :SUCK thermistors CN17 :discharge pipe)
- 8) CN23 Connector for communicate between the control board and the module board
- 9) CN25 CN8 Connector for the L N to the module board
- 10) CN4 Connector for communicate between the indoor board and the outdoor board
- 11) CN26 Connector for capacitance anode
- 12) CN24 Connector for capacitance cathode

##### PCB(2) (module PCB)

- CN10 Connector for the DC power 5V and 15V form the control PCB
- CN11 Connector for communicate between the control board and the module board
- P( CN1) N(CN5) Connector for capacitance board
- LI (CN7) LO(CN6) Connector for reactor
- CN2 CN3 CN4 Connector for the U V W wire of the compressor

#### **Note:** Other Designations

##### PCB(1) (Control PCB)

- 1) FUSE 1 (25A,250VAC) FUSE 2(1A,250VAC)
- 2)LED 1 keep light representative normal ,if keep flash interval representative trouble Alarm
- 3)RV1 RV2 RV3 Varistor

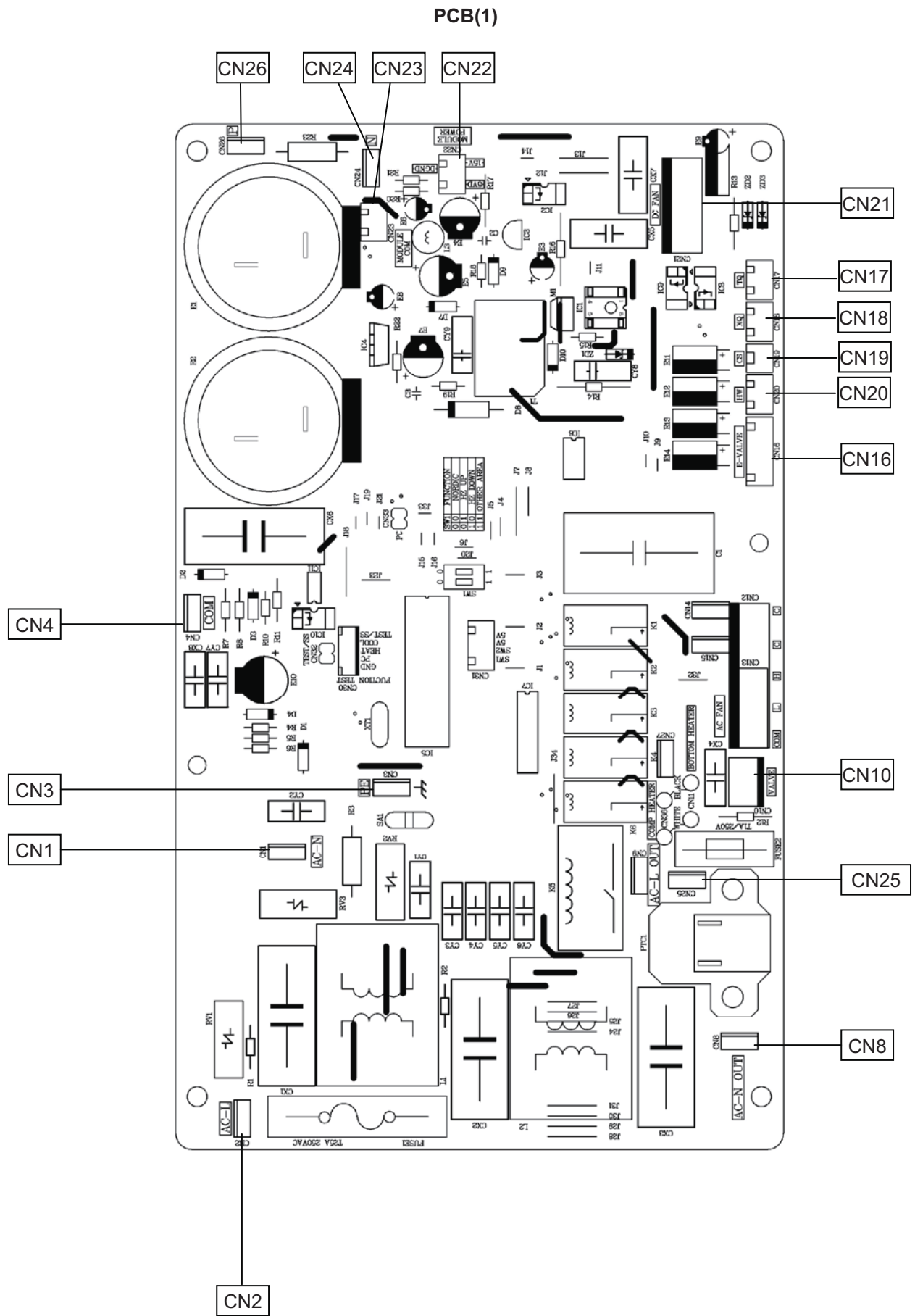



**FOR 18K****Connectors****PCB(1) (Control PCB)**

- 1) CN1 CN2 Connector for power N and L
- 2) CN3 Connector for ground
- 3) CN22 Connector for DC POWER 15V and 5V to the module board
- 4) CN16 Connector for electric expansion valves
- 5) CN21 Connector for DC fan motor
- 6) CN10 Connector for four way valve coil
- 7) CN17 CN18 CN19 CN20 Connector for thermistors  
(CN20: outdoor air CN19: heat exchanger CN18 :SUCK thermistors CN17 :discharge pipe)
- 8) CN23 Connector for communicate between the control board and the module board
- 9) CN25 CN8 Connector for the L N to the module board
- 10) CN4 Connector for communicate between the indoor board and the outdoor board
- 11) CN26 Connector for capacitance anode
- 12) CN24 Connector for capacitance cathode

**PCB(2) (module PCB)**

- CN10 Connector for the DC power 5V and 15V form the control PCB
- CN11 Connector for communicate between the control board and the module board
- P( CN1) N(CN5) Connector for capacitance board
- LI (CN7) LO(CN6) Connector for reactor
- CN2 CN3 CN4 Connector for the U V W wire of the compressor

**Note:** Other Designations

## PCB(1) (Control PCB)

- 1) FUSE 1 (25A,250VAC) FUSE 2(1A,250VAC)
- 2)LED 1 keep light representative normal if keep flash interval representative trouble Alarm
- 3)RV1 RV2 RV3 Varistor

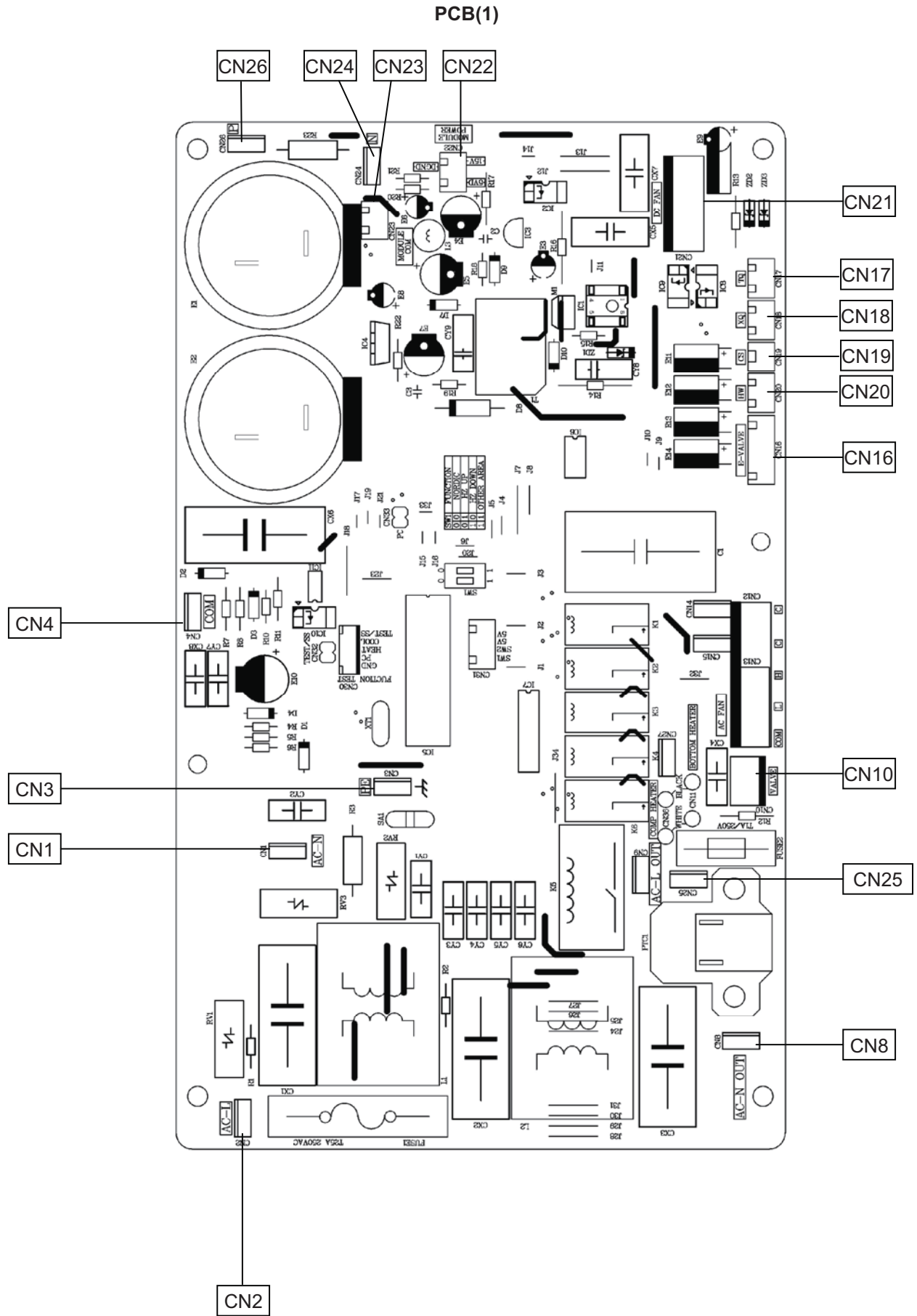

PCB(2)

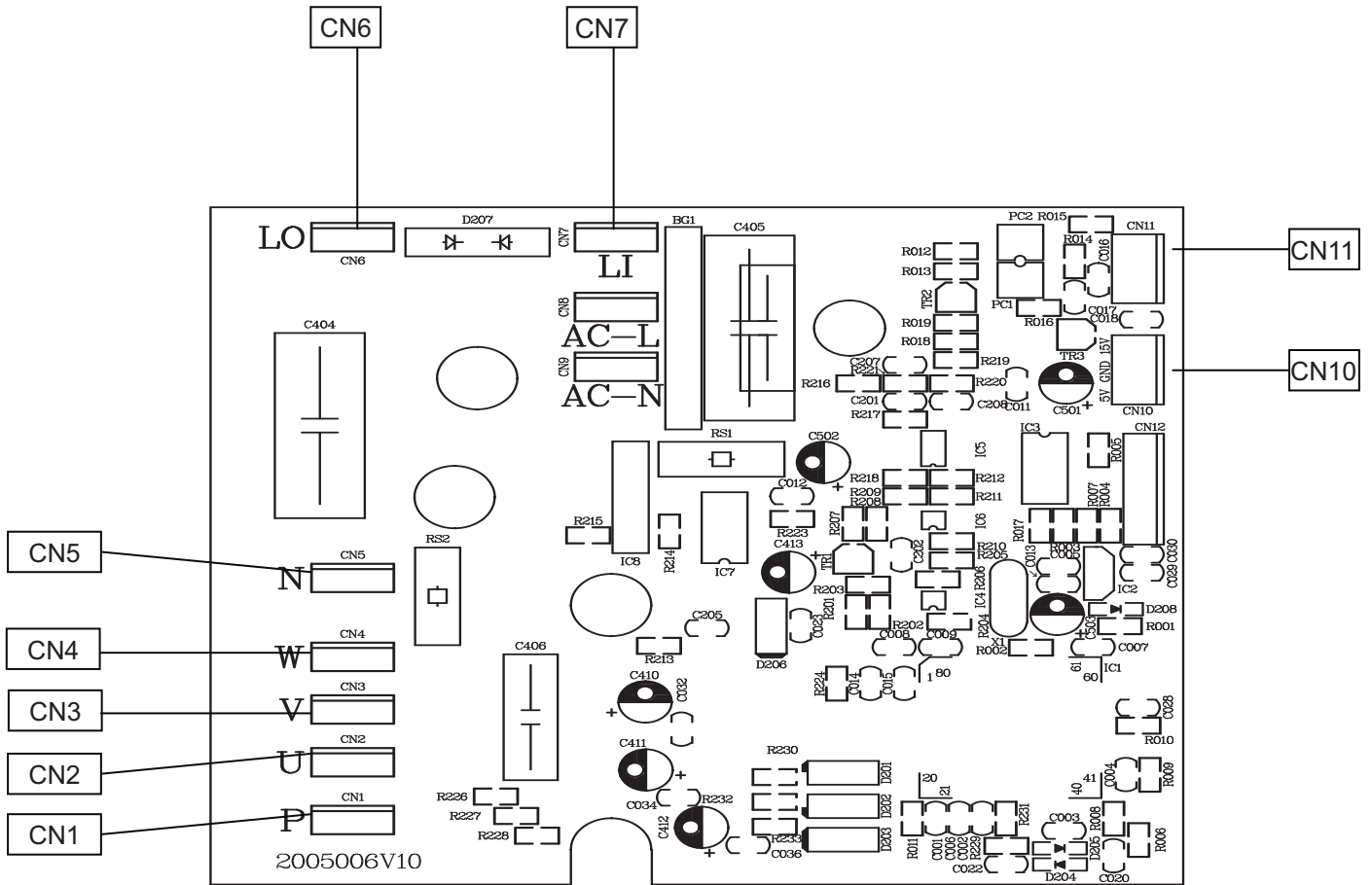



# 5.Functions and Control

## 5.1 Main functions and control specification of indoor unit

This specification use for HSU12/18VHJ(DB) frequency conversion air condition are manufactured by Haier air condition parent company. "Setting value" (express in parameter) in this specification means is a parameter that is stored in EEPROM. Refer to [EEPROM parameter table].

### 5.1.1 Temperature Adjusting function

#### 5.1.1.1 Temperature adjusting of different levels.

(DASH operation conditions under different modes)

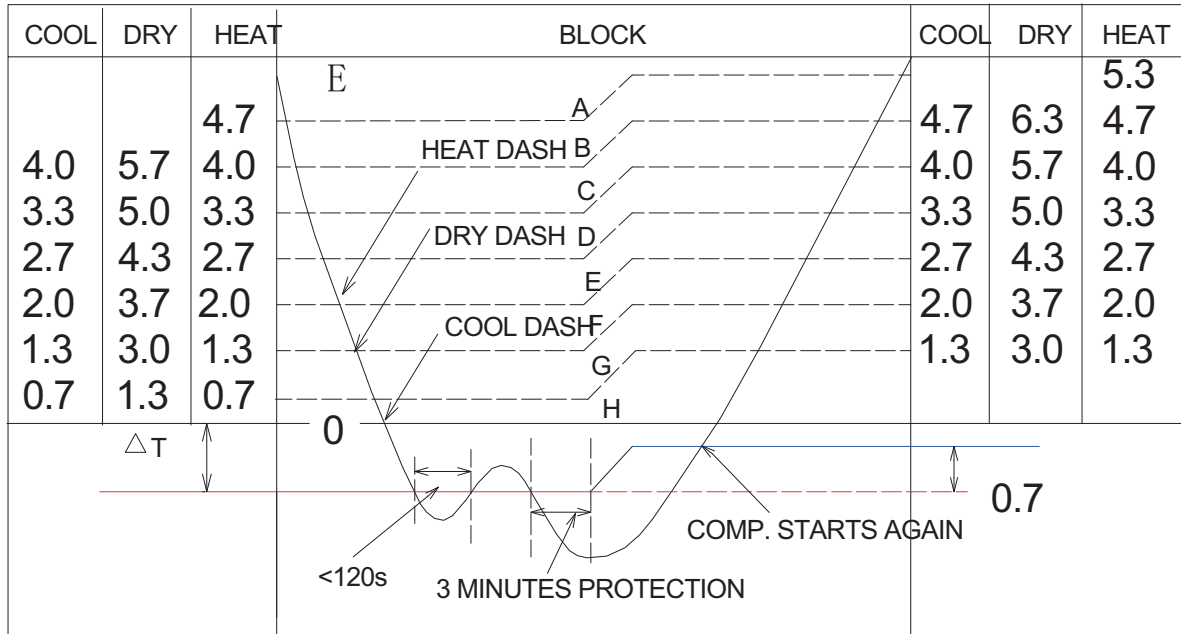

#### 5.1.1.2 Select the wind volume when it is set automatic

When the wind volume is automatic, it can be switched between strong, medium and weak according to the temperature adjusting levels.

Wind volume under the automatic wind volume mode

	Temperature adjusting levels								
	A	B	C	D	E	F	G	H	I
Heating	Strong	Strong	Strong	Strong	Strong	Medium	Weak	Weak	SLO
cooling		Strong	Strong	Strong	Medium	Medium	Weak	Weak	Weak
Moisture removing		Strong	Medium	Medium	Medium	Weak	Weak	SLO	SLO

### 5.1.1.3 Wind volume limit

When the compressor is working and the max setting for indoor fan motor is medium or weak, the upper limit of indicated frequency is as follows:

Frequency control form for wind volume

	Limited frequency variables	Limited frequency
Medium wind volume	FQLIMMD	70Hz
Weak wind volume	FQLIMLO	58Hz
Limited frequency for up/down health wind	FUPHEAL	48Hz

## 5.1.2 Main functions

### 5.1.2.1 Warm boot

When the heat running starts or the frost removing ends and the compressor starts again, in order to avoid cold wind, warm boot wind volume control should be done.

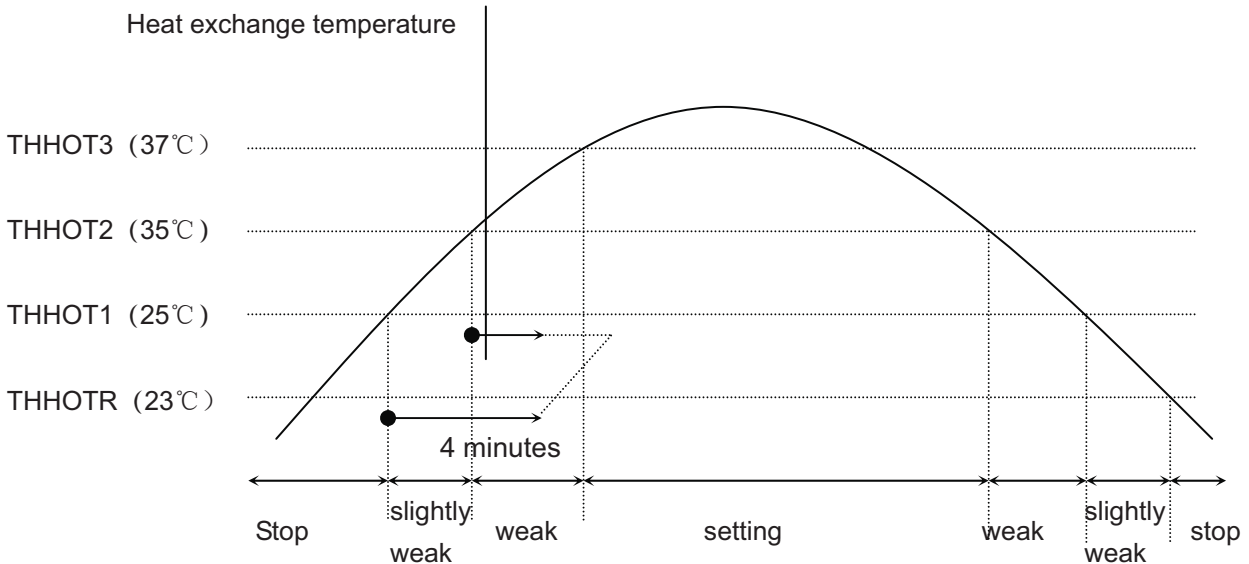

To control the indoor fan motor as shown in the table above according to the heat exchange temperature

The fan motor stops when the heat exchange temperature is below 25°C

The fan motor is working slightly weak when the heat exchange temperature is above 25 °C and below 35°C

The fan motor is working weak when the heat exchange temperature is above 35 °C and below 37°C

The fan motor works as set if the heat exchange temperature remains above 38°C

### 5.1.2.2 When the compressor stops and remains idle for 3 minutes

20 seconds after the compressor stops, the up wind volume is weak (switching to SSLO in silent running mode) and then slightly weak. While the down wind volume is stopped. If the compressor stops when the heat running starts, the wind volume is weak.

### 5.1.2.3 Dehumidification running

Under the dehumidification mode the fan motor stops as the compressor stops.

The operation is weak after 3 minutes' idle mode.

After stand by for 3 minutes, the compressor is on.

The compressor operates as the set wind volume when the wind volume is set to be strong, medium or weak.

The wind volume is decided according to the temperature adjusting when the wind volume is set to be automatic.

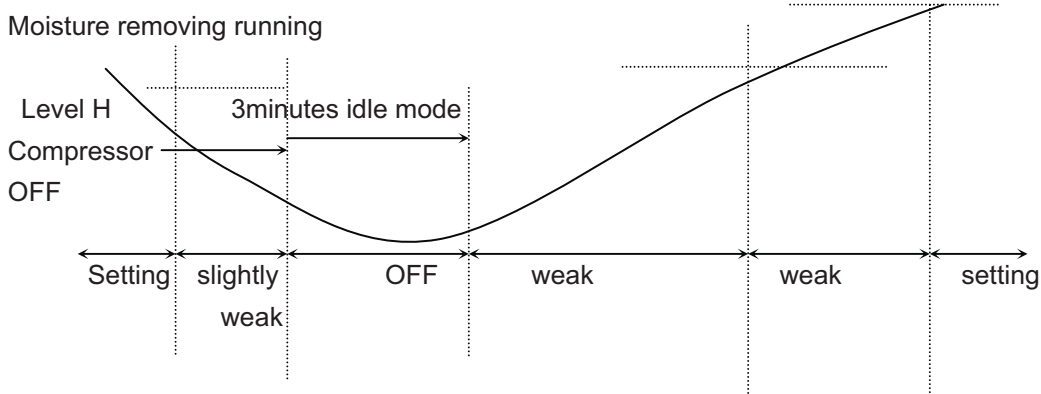

### 5.1.2.4 Automatic running

When the running mode is turned to automation after starting the system, the system will first determine the running mode according to the current room temperature and then will run according to the determined mode. Tr in the following selection conditions means room temperature, Ts means setting temperature, Tp means temperature of indoor coil pipe.

$Tr \geq 23^\circ\text{C}$  Choose Cooling Mode

$Tr < 23^\circ\text{C}$  Choose Heating Mode

After turning to the automation mode, the running mode can be switched between cooling mode, fan mode and heating mode according to the change of the indoor ambient temperature. But the automatic conversion between cooling mode and heating mode must be conducted after 15 minutes.

## 5.1.3 Special functions

### 5.1.3.1 Powerful running

Powerful running for 15 minutes

The running stops or ends the powerful running after 15 minutes

The mode switch ends the powerful running

Enter into the silent mode, normal running mode or timed switching on mode to end the powerful running

When in automatic mode, there are powerful and silent functions for your choice. When the main unit

is in cooling mode, it operates with powerful cooling or silent cooling. When the main unit is in heating mode, it operates with powerful heating or silent heating. When the main unit is in wind-sending mode, there are no powerful or silent modes.

There is no powerful mode for wind-sending and moisture removing

#### **Powerful heating:**

Change the set temperature. With temperature adjusting function

The wind volume is the automatic medium

When in frost removing mode, the outdoor unit does not accept the communication signal for powerful running

After 15 minutes of powerful running, the compressor can not be off within 10 minutes

#### **Powerful cooling:**

Change the set temperature. With temperature adjusting function

The wind volume is the automatic strong

After the compressor starts, there will be no low-intense running protection within 3 minutes

### **5.1.3.2 Silent running**

Send the silent running signal to the outdoor unit

Under the Silent heating mode, The wind volume is SSLO after the compressor is on, The wind volume will be kept SSLO within 20 seconds after the compressor stops and then changes to weak

Under the Silent cooling mode the wind volume is SSLO

There is no silent mode for moisture removing and wind-sending.

### **5.1.3.3 Air cleaning**

If the fan motor starts working after receiving the remote-control order, the aion generator starts working and sends out ions.

The ion generator stops as the fan motor stops.

When the ion generator is OFF and the air cleaning function is on, the fan motor starts running and the ion generator starts working again.

### **5.1.3.4 Timed running**

Set the time duration according to the time difference between the clock for timing and the current clock

In timing mode, the display panel will flash the light at fixed times

<b>Timed OFF</b>	When this function is set, operation modes on the panel display will not change. The timing icon will show and the operation stops when the set time comes.
<b>Timed ON</b>	When this function is on, the panel display will only display a question mark. The unit will operate as the set mode when the time comes.
<b>Timed ON/OFF</b>	The unit will start operating or stop according to the order of your setting.

### 5.1.3.5 Sleeping function

a. After setting the sleeping function, the refrigerating mode and dehumidification mode will run as per the following rules:

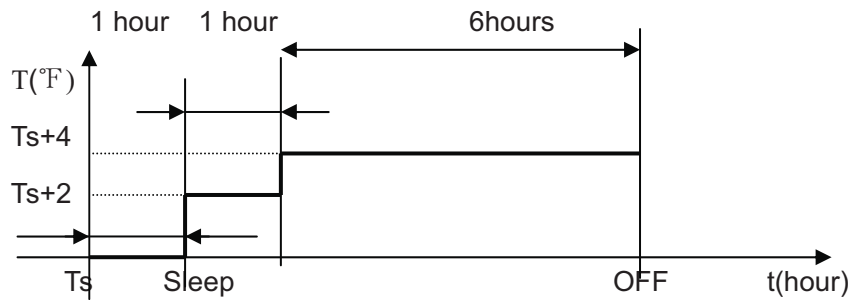

b. After setting the sleeping function, the heating mode will run as per the following rules:

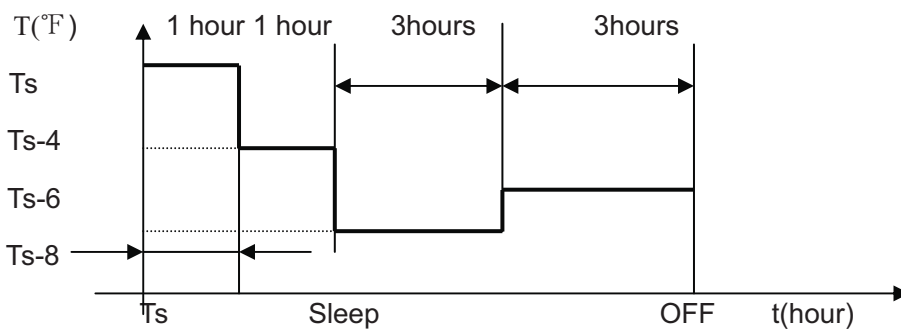

As shown in the above diagram, after running for 1 hour under refrigerating mode and dehumidification mode, the setting temperature will increase about  $2^{\circ}\text{F}$ ; after another 1 hour, it will increase about  $2^{\circ}\text{F}$  again, and after 6 hours, it will cease; after running for 1 hour under heating mode, the setting temperature will decrease about  $4^{\circ}\text{F}$ , after another 1 hour, it will decrease the about  $4^{\circ}\text{F}$  again, and after 3 hours, it will increase about  $2^{\circ}\text{F}$ , and after other 3 hours, it will cease.

### 5.1.3.6 Trial running

The indicated frequency for trial running is 58Hz, wind volume is strong.

The trial running will last for 30 minutes and then the unit will be powered off. The unit will exit the trial running if it receives any remote-control signal during the trial running period.

There is no low-intense running protection.

### 5.1.3.7 Power failure compensation

To enter into the function please press the sleep key 10 times with 4 beeps in 7 seconds

Under the power failure compensation mode, unplug and plug again, the indoor unit will resume original operation

Under the power failure compensation mode, unplug and plug again, the unit will be on OFF state.

Mode, Fan speed, Healthy, Set temperature can be memoried. Swing, Timer, Sleep cannot be memoried

Press the sleep key for 10 times with 2 beeps in 7 seconds to exit.

### 5.1.3.8 Rated Operation

Rated Cooling:

When receiving the instruction of indoor unit rated operation, the unit will start rated cooling operation.

Rated Heating:

When receiving the instruction of indoor unit rated operation, the unit will start rated heating operation.

---

## 5.2 Main functions and control specification of outdoor unit

Sensor Code Definition: Tai= Indoor Ambient Temperature, Tao=Outdoor Ambient Temperature, Tc1=Indoor Coil, Td= Air Discharge, Te= Outdoor Coil, Ts=Air Intake

### 5.2.1 Outdoor Unit Operation Frequency and Control

#### Compressor Operation Frequency Range

Compressor Operation Frequency Range:

Outdoor Temperature	$\leq 4$	4 ~ 18	$\geq 18$
Heating (Hz)	20 ~ 110	20 ~ 90	20 ~ 53
Defrosting (Hz)	80		
Outdoor Temperature	$\leq 23$	23 ~ 32	$\geq 32$
Cooling (Hz)	20 ~ 50	20 ~ 70	20 ~ 95

#### Compressor Startup

Regardless of target frequency of indoor unit, each time when compressor is from off to on, it must maintain 60Hz,90Hz for one minute (Frequency will be immediately decreased under the condition that outdoor unit air discharge temperature overheating protection is activated or over current of compressor) then the compressor will operate towards target frequency. This process does not exist in normal operation of unit.

#### Heating

When completing compressor startup operation, it will operate as per frequency of indoor unit. After 2 minutes, compressor operation frequency will be compensated as per relevant conditions.

#### Cooling & Dehumidification:

When completing compressor startup operation, it will operate as per frequency of indoor unit. After 2 minutes, compressor operation frequency will be compensated as per relevant conditions.

#### Compressor Frequency Increase/Decrease Speed

Rapid Frequency Increase/Decrease Speed 1 -----1Hz/s

Slow Frequency Increase/Decrease Speed 2 -----1Hz/10s

## 5.2.2 Outdoor fan control

**Compressor startup within 3min ,outdoor fan speed control as follows:**

Outdoor Temperature	<10	10~25	≥ 25
Cooling/ Dehumidification	1	3	7
Heating	5	3	2

**After compressor runs 3min ,outdoor fan speed control as follows:**

Cooling/ Dehumidification:

Compressor Operation Frequency ( Hz )		<25	25 ~ 45	≥45
Tao ( °C )	32 ~ 38	3	4	7
	23~32	1	2	5
	<23			
	≥38	7		

Heating:

Compressor Operation Frequency (Hz)		<25	25 ~ 45	≥45
Tao ( °C )	≤4	3	4	7
	4~18	2	4	7
	≥18	1		

### Compressor shutdown and outdoor fan residual heat blow process

When compressor shuts down in cooling mode, outdoor fan automatically jumps to low speed and blows residual heat for 30s and stop.

## 5.2.3 Four-way Valve Control

Defrosting Four-way Valve Control, (please see defrosting process for details)

Time sequence of the defrosting operation is as follows:

Four-way Valve Work Status in Other Modes:

In heating mode, four-way valve is on. If compressor is off or is switched to non-heating mode, four-way valve ensures that it is off at least 2 minutes after compressor shuts down.

## 5.2.4 Outdoor Defrosting Control

### Defrosting Mode Entry Conditions

The unit will enter defrosting mode when compressor starts up and operates for 10 minutes continuously in heating mode or after compressor runs for an accumulated time of 45 minutes (Upon completion of defrosting or when switched to cooling mode, compressor accumulated operation time will be cleared) and when 2 minutes' continuous checking by defrosting sensor TE (check frosting condition of outdoor unit heat exchanger) and outdoor ambient temperature sensor TA meets the following conditions:



$$TE \leq C \times TA - \alpha$$

Among which:  $C: TA < 0^\circ\text{C}$ ,  $C=0.8$

$$TA \geq 0^\circ\text{C}, C=0.6$$

For area prone to frost, the value is set at 6 when unit leaves the factory.

Defrosting entry temperature control  $-15^\circ\text{C} \leq C \times TA - \alpha \leq 5^\circ\text{C}$

---

### Defrosting Time Interval

time interval between two defrosting cycles is 45 minutes.

### Defrosting Operation

When defrosting begins, compressor will stop for one minute, external fan is running and 50s later, four-way valve will be off.

When compressor starts, external fan will be off, compressor will run at 58Hz for 60s then move on to target frequency of 88Hz.

During defrosting, compressor current and air discharge overheat protection features are effective.

During defrosting, if compressor shuts down due to activation of protection feature or due to malfunction, it will resume after 3 minutes. In the unit is still within defrosting cycle, it will resume defrosting and startup of compressor will be based on the rule for defrosting startup. (The unit will exit defrosting mode and handle fault in the event of 3 consecutive restart failures.)

On entering defrosting, it must guarantee that compressor will operate for a minimum of 2 minutes in defrosting mode before exit.

---

### Defrosting Exit Condition

When one of the following conditions is met, defrosting operation will be switched to heating operation.

- (1) : Temperature of outdoor heat exchanger exceeds  $7^\circ\text{C}$  for 80s continuously
  - (2) : Temperature of outdoor heat exchanger exceeds  $12^\circ\text{C}$  for 5s continuously
  - (3) : Defrosting operation continues for 11 minutes.
- 

### When defrosting exit conditions are met, the unit will operate as follows

Compressor stops and external fan starts, 50s later, four-way valve will be on, 60s later, compressor will operate as per startup process.

---

## 5.2.5 PTC Output Control

When outdoor unit is energized, PTC output value is 0, 10s later, output value is 1.

When compressor stops for 10 minutes continuously, PTC output value is 0.

On receiving compressor startup instruction, initial PTC output is 1, and compressor startup will be performed 5s later.

---

## 5.2.6 System Protection Function

### 5.2.6.1 3 minutes stand-by time

Time interval between compressor shutdown and restart is set at 3 minutes to ensure that compressor will only restart after 3-minute shutdown and initial energization valves are turned on to adequate opening position after being fully turned off.

### 5.2.6.2 TD High Temperature Protections

As long as unit is on, the TD air discharge overheat protection feature will be activated, yet air discharge sensor fault must be alarmed 4 minutes after compressor starts.

TD (°C)

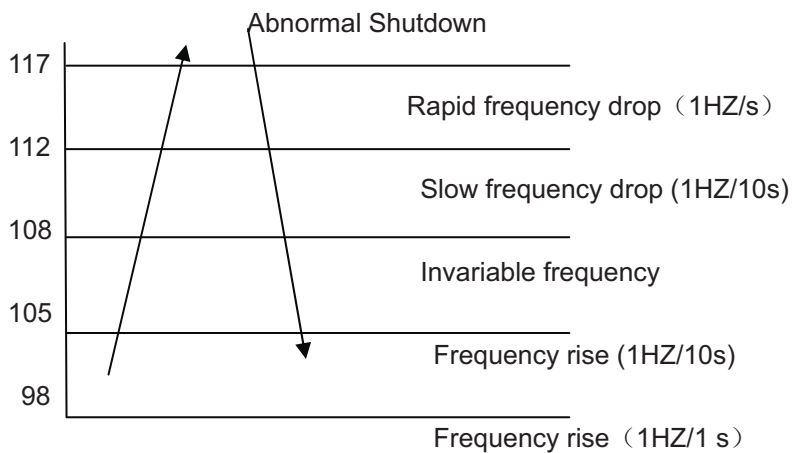

When TD > 117°C for 20s continuously, air discharge overheat protection will be activated and fault will be reported to indoor unit.

It will not continue in other conditions.

### 5.2.6.3 Indoor Heat Exchanger Anti-freeze Protection

Anti-freeze during cooling

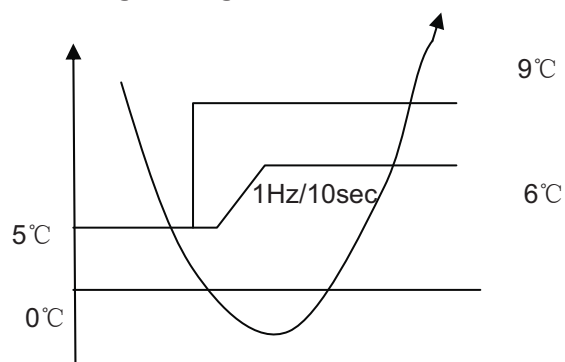

When TC < 5°C, compressor frequency will drop at a speed of 1HZ/10s

When TC starts to rise, and 6 ≤ TC ≤ 9°C, compressor frequency will remain unchanged.

When 9 < TC < 11°C, frequency will rise normal.

If TC ≤ 0°C, for 2 consecutive minutes, compressor will shutdown and outdoor fault lamp blinks. Fault will not be reported to indoor unit.

When compressor shuts down for more than 3 minutes, and when TC > 9°C, compressor will restart.

#### 5.2.6.4 Outdoor Temperature Limit

Cooling: When outdoor temperature is lower than 23°C, cooling operation will start, compressor frequency is limited to less than 50 HZ, outdoor wind speed is forced at level 1.

Heating: When outdoor temperature is higher than 18°C, heating operation will start, compressor frequency is limited to less than 53 HZ, outdoor wind speed is forced at level 1.

---

#### 5.2.6.5 Special Features

1. Forced Cooling: When receiving indoor forced cooling signal, cooling operation will start in a frequency signaled by indoor unit. Only air discharge temperature and over current protection features are effective and other protection features are invalid.

2. Rated, Middle and Minimum Capacity Operation: When receiving indoor, rated, middle and minimum capacity operation signal, outdoor unit will operate as per wind speed and frequency set by EEPROM and all the protection features are effective.

---

#### 5.2.6.6 Fault Display and Treatment

In case outdoor unit faults, the alarm indicator lamp will blink and blink frequency is 1HZ, Time interval between blink cycles is 3s.

Alarm indicator lamp is off when there is no fault.

## 5.3 Function of Main Thermistor

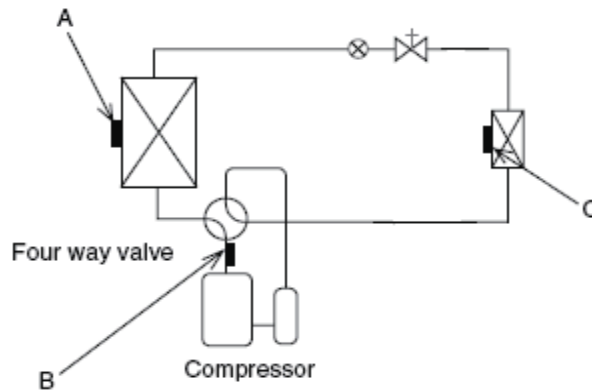

**Note:** A: Outdoor suction temperature sensor

B: Exhaust temperature sensor

C: Indoor heat-exchange sensor

### Outdoor Suction Temperature Sensor

The outdoor heat exchanger thermistor is used for controlling target discharge temperature. The system sets a target discharge temperature according to the outdoor and indoor heat exchanger temperature, and controls the electronic expansion valve opening so that the target discharge temperature can be obtained.

### Exhaust Temperature Sensor

The discharge pipe thermistor is used for controlling temperature of the discharge pipe. If the temperature of discharge pipe (used in place of the inner temperature of the compressor) rises abnormally, the operating frequency drops or the operation halts.

### Indoor heat-exchange sensor

1. The indoor heat exchanger thermistor is used for controlling target discharge temperature. The system sets a target discharge temperature according to the outdoor and indoor heat exchanger temperature, and controls the electronic expansion valve opening so that the target discharge temperature can be obtained.

2. The indoor heat exchanger thermistor is used for preventing freezing. During the cooling operation, if the temperature drops abnormally, the operating frequency becomes lower, then the operation halts.

3. The indoor heat exchanger thermistor is used for anti-icing control. During the cooling operation, if the heat exchanger temperature in the room where operation is halted becomes  $-1^{\circ}\text{C}$ , it is assumed as icing.

## 5.4 Value of Thermistor

### 5.4.1 indoor Unit

#### Room sensor

$R_{25^{\circ}\text{C}}=23\text{K}\Omega\pm 3.5\%$

$B_{25^{\circ}\text{C}/50^{\circ}\text{C}}=4200\text{K}\pm 3\%$

Temp.(°C)	Max.(KΩ)	Normal(KΩ)	Min.(KΩ)	Tolerance(°C)	
-30	568.8372	501.0746	440.8435	-1.97	1.75
-29	530.9600	468.6491	413.1441	-1.95	1.74
-28	495.8488	438.5314	387.3645	-1.93	1.72
-27	463.2850	410.5433	363.3602	-1.91	1.71
-26	433.0683	384.5212	340.9980	-1.90	1.70
-25	405.0156	360.3153	320.1558	-1.88	1.69
-24	378.9588	337.7879	300.7211	-1.86	1.67
-23	354.7440	316.8126	282.5905	-1.84	1.66
-22	332.2300	297.2732	265.6686	-1.82	1.64
-21	311.2873	279.0627	249.8676	-1.80	1.63
-20	291.7969	262.0831	235.1067	-1.78	1.62
-19	273.6494	246.2437	221.3111	-1.76	1.60
-18	256.7445	231.4612	208.4122	-1.74	1.59
-17	240.9897	217.6590	196.3462	-1.72	1.57
-16	226.3000	204.7662	185.0545	-1.70	1.56
-15	212.5973	192.7176	174.4829	-1.68	1.54
-14	199.8093	181.4531	164.5813	-1.66	1.53
-13	187.8698	170.9169	155.3033	-1.64	1.51
-12	176.7176	161.0578	146.6059	-1.62	1.49
-11	166.2961	151.8284	138.4495	-1.60	1.48
-10	156.5532	143.1847	130.7973	-1.58	1.46
-9	147.4409	135.0863	123.6153	-1.56	1.44
-8	138.9148	127.4956	116.8717	-1.53	1.43
-7	130.9337	120.3778	110.5374	-1.51	1.41
-6	123.4597	113.7009	104.5852	-1.49	1.39
-5	116.4577	107.4349	98.9897	-1.47	1.38
-4	109.8953	101.5523	93.7278	-1.45	1.36
-3	103.7422	96.0274	88.7774	-1.43	1.34
-2	97.9708	90.8365	84.1185	-1.40	1.32
-1	92.5551	85.9574	79.7322	-1.38	1.30
0	87.4712	81.3697	75.6011	-1.36	1.29
1	82.6970	77.0544	71.7088	-1.34	1.27
2	78.2118	72.9937	68.0402	-1.31	1.25
3	73.9966	69.1712	64.5813	-1.29	1.23
4	70.0335	65.5716	61.3188	-1.27	1.21
5	66.3062	62.1807	58.2405	-1.24	1.19
6	62.7992	58.9853	55.3351	-1.22	1.17
7	59.4984	55.9729	52.5917	-1.20	1.15

8	56.3905	53.1320	50.0006	-1.17	1.13
9	53.4631	50.4521	47.5523	-1.15	1.11
10	50.7048	47.9230	45.2384	-1.13	1.09
11	48.1049	45.5355	43.0505	-1.10	1.07
12	45.6534	43.2808	40.9813	-1.08	1.04
13	43.3410	41.1509	39.0236	-1.05	1.02
14	41.1592	39.1381	37.1708	-1.03	1.00
15	39.0998	37.2355	35.4167	-1.00	0.98
16	37.1553	35.4363	33.7555	-0.98	0.96
17	35.3186	33.7344	32.1818	-0.95	0.94
18	33.5833	32.1240	30.6905	-0.93	0.91
19	31.9432	30.5997	29.2769	-0.90	0.89
20	30.3925	29.1565	27.9365	-0.88	0.87
21	28.9259	27.7895	26.6651	-0.85	0.84
22	27.5383	26.4944	25.4589	-0.83	0.82
23	26.2252	25.2670	24.3140	-0.80	0.80
24	24.9822	24.1034	23.2271	-0.78	0.77
25	23.8050	23.0000	22.1950	-0.78	0.77
26	22.7500	21.9499	21.1520	-0.78	0.78
27	21.7477	20.9536	20.1638	-0.82	0.81
28	20.7951	20.0081	19.2272	-0.86	0.85
29	19.8895	19.1104	18.3394	-0.89	0.88
30	19.0285	18.2581	17.4974	-0.93	0.92
31	18.2094	17.4484	16.6988	-0.97	0.95
32	17.4302	16.6792	15.9410	-1.00	0.99
33	16.6885	15.9480	15.2217	-1.04	1.02
34	15.9825	15.2530	14.5389	-1.08	1.06
35	15.3103	14.5920	13.8903	-1.12	1.09
36	14.6700	13.9632	13.2743	-1.16	1.13
37	14.0599	13.3650	12.6889	-1.20	1.16
38	13.4786	12.7957	12.1325	-1.23	1.20
39	12.9244	12.2537	11.6035	-1.27	1.24
40	12.3960	11.7375	11.1004	-1.31	1.27
41	11.8921	11.2459	10.6218	-1.35	1.31
42	11.4113	10.7775	10.1665	-1.39	1.34
43	10.9526	10.3311	9.7330	-1.43	1.38
44	10.5147	9.9056	9.3204	-1.48	1.42
45	10.0967	9.4999	8.9275	-1.52	1.45
46	9.6976	9.1130	8.5532	-1.56	1.49
47	9.3163	8.7439	8.1965	-1.60	1.53
48	8.9521	8.3916	7.8566	-1.64	1.57
49	8.6040	8.0554	7.5327	-1.68	1.60
50	8.2713	7.7345	7.2237	-1.73	1.64
51	7.9531	7.4280	6.9291	-1.77	1.68
52	7.6489	7.1353	6.6480	-1.81	1.72

53	7.3580	6.8556	6.3797	-1.85	1.76
54	7.0796	6.5884	6.1237	-1.90	1.79
55	6.8131	6.3329	5.8793	-1.94	1.83
56	6.5581	6.0887	5.6459	-1.99	1.87
57	6.3140	5.8552	5.4230	-2.03	1.91
58	6.0802	5.6318	5.2100	-2.07	1.95
59	5.8563	5.4181	5.0065	-2.12	1.99
60	5.6417	5.2136	4.8120	-2.16	2.03
61	5.4361	5.0178	4.6260	-2.21	2.07
62	5.2391	4.8304	4.4481	-2.25	2.11
63	5.0502	4.6510	4.2780	-2.30	2.15
64	4.8691	4.4791	4.1153	-2.35	2.19
65	4.6954	4.3145	3.9596	-2.39	2.23
66	4.5287	4.1567	3.8105	-2.44	2.27
67	4.3689	4.0055	3.6678	-2.49	2.31
68	4.2154	3.8605	3.5312	-2.53	2.35
69	4.0682	3.7216	3.4004	-2.58	2.39
70	3.9268	3.5883	3.2750	-2.63	2.43
71	3.7910	3.4605	3.1549	-2.68	2.48
72	3.6606	3.3378	3.0398	-2.73	2.52
73	3.5353	3.2201	2.9294	-2.77	2.56
74	3.4150	3.1072	2.8237	-2.82	2.60
75	3.2993	2.9987	2.7222	-2.87	2.64
76	3.1881	2.8946	2.6249	-2.92	2.68
77	3.0812	2.7946	2.5316	-2.97	2.73
78	2.9785	2.6986	2.4420	-3.02	2.77
79	2.8796	2.6063	2.3560	-3.07	2.81
80	2.7845	2.5176	2.2735	-3.12	2.86
81	2.6931	2.4324	2.1943	-3.17	2.90
82	2.6050	2.3505	2.1182	-3.22	2.94
83	2.5203	2.2717	2.0451	-3.28	2.99
84	2.4388	2.1960	1.9749	-3.33	3.03
85	2.3602	2.1231	1.9075	-3.38	3.07
86	2.2846	2.0530	1.8426	-3.43	3.12
87	2.2118	1.9856	1.7803	-3.48	3.16
88	2.1416	1.9207	1.7204	-3.54	3.20
89	2.0740	1.8582	1.6628	-3.59	3.25
90	2.0089	1.7981	1.6074	-3.64	3.29
91	1.9461	1.7402	1.5541	-3.70	3.34
92	1.8856	1.6844	1.5028	-3.75	3.38
93	1.8272	1.6307	1.4535	-3.80	3.43
94	1.7709	1.5789	1.4060	-3.86	3.47
95	1.7166	1.5291	1.3603	-3.91	3.52
96	1.6643	1.4810	1.3163	-3.97	3.56

97	1.6138	1.4347	1.2739	-4.02	3.61
98	1.5650	1.3900	1.2331	-4.08	3.66
99	1.5180	1.3470	1.1937	-4.13	3.70
100	1.4726	1.3054	1.1559	-4.19	3.75
101	1.4287	1.2654	1.1194	-4.24	3.80
102	1.3864	1.2268	1.0842	-4.30	3.84
103	1.3455	1.1895	1.0503	-4.36	3.89
104	1.3060	1.1535	1.0176	-4.42	3.94
105	1.2679	1.1188	0.9860	-4.47	3.98
106	1.2310	1.0853	0.9556	-4.53	4.03
107	1.1954	1.0529	0.9263	-4.59	4.08
108	1.1610	1.0217	0.8980	-4.65	4.13
109	1.1277	0.9915	0.8707	-4.70	4.17
110	1.0955	0.9624	0.8443	-4.76	4.22
111	1.0644	0.9342	0.8189	-4.82	4.27
112	1.0344	0.9070	0.7943	-4.88	4.32
113	1.0053	0.8807	0.7706	-4.94	4.37
114	0.9771	0.8553	0.7478	-5.00	4.41
115	0.9499	0.8307	0.7256	-5.06	4.46
116	0.9235	0.8070	0.7043	-5.12	4.51
117	0.8980	0.7840	0.6837	-5.18	4.56
118	0.8734	0.7618	0.6637	-5.24	4.61
119	0.8495	0.7404	0.6445	-5.30	4.66
120	0.8263	0.7196	0.6258	-5.36	4.71

## Pipe Sensor

R25°C=10KΩ±3%

B25°C/50°C=3700K±3%

Temp.((°C))	Max.(KΩ)	Normal(KΩ)	Min.(KΩ)	Tolerance(°C)	
-30	165.2170	147.9497	132.3678	-1.94	1.75
-29	155.5754	139.5600	125.0806	-1.93	1.74
-28	146.5609	131.7022	118.2434	-1.91	1.73
-27	138.1285	124.3392	111.8256	-1.89	1.71
-26	130.2371	117.4366	105.7989	-1.87	1.70
-25	122.8484	110.9627	100.1367	-1.85	1.69
-24	115.9272	104.8882	94.8149	-1.83	1.67
-23	109.4410	99.1858	89.8106	-1.81	1.66
-22	103.3598	93.8305	85.1031	-1.80	1.64
-21	97.6556	88.7989	80.6728	-1.78	1.63
-20	92.3028	84.0695	76.5017	-1.76	1.62
-19	87.2775	79.6222	72.5729	-1.74	1.60
-18	82.5577	75.4384	68.8710	-1.72	1.59
-17	78.1230	71.5010	65.3815	-1.70	1.57
-16	73.9543	67.7939	62.0907	-1.68	1.55
-15	70.0342	64.3023	58.9863	-1.66	1.54



-14	66.3463	61.0123	56.0565	-1.64	1.52
-13	62.8755	57.9110	53.2905	-1.62	1.51
-12	59.6076	54.9866	50.6781	-1.60	1.49
-11	56.5296	52.2278	48.2099	-1.58	1.47
-10	53.6294	49.6244	45.8771	-1.56	1.46
-9	50.8956	47.1666	43.6714	-1.54	1.44
-8	48.3178	44.8454	41.5851	-1.51	1.42
-7	45.8860	42.6525	39.6112	-1.49	1.40
-6	43.5912	40.5800	37.7429	-1.47	1.39
-5	41.4249	38.6207	35.9739	-1.45	1.37
-4	39.3792	36.7676	34.2983	-1.43	1.35
-3	37.4465	35.0144	32.7108	-1.41	1.33
-2	35.6202	33.3552	31.2062	-1.38	1.31
-1	33.8936	31.7844	29.7796	-1.36	1.29
0	32.2608	30.2968	28.4267	-1.34	1.28
1	30.7162	28.8875	27.1431	-1.32	1.26
2	29.2545	27.5519	25.9250	-1.29	1.24
3	27.8708	26.2858	24.7686	-1.27	1.22
4	26.5605	25.0851	23.6704	-1.25	1.20
5	25.3193	23.9462	22.6273	-1.23	1.18
6	24.1432	22.8656	21.6361	-1.20	1.16
7	23.0284	21.8398	20.6939	-1.18	1.14
8	21.9714	20.8659	19.7982	-1.15	1.12
9	20.9688	19.9409	18.9463	-1.13	1.09
10	20.0176	19.0621	18.1358	-1.11	1.07
11	19.1149	18.2270	17.3646	-1.08	1.05
12	18.2580	17.4331	16.6305	-1.06	1.03
13	17.4442	16.6782	15.9315	-1.03	1.01
14	16.6711	15.9601	15.2657	-1.01	0.99
15	15.9366	15.2770	14.6315	-0.98	0.96
16	15.2385	14.6268	14.0271	-0.96	0.94
17	14.5748	14.0079	13.4510	-0.93	0.92
18	13.9436	13.4185	12.9017	-0.91	0.90
19	13.3431	12.8572	12.3778	-0.88	0.87
20	12.7718	12.3223	11.8780	-0.86	0.85
21	12.2280	11.8126	11.4011	-0.83	0.83
22	11.7102	11.3267	10.9459	-0.81	0.80
23	11.2172	10.8634	10.5114	-0.78	0.78
24	10.7475	10.4216	10.0964	-0.75	0.75
25	10.3000	10.0000	9.7000	-0.75	0.75
26	9.8975	9.5974	9.2980	-0.76	0.76
27	9.5129	9.2132	8.9148	-0.80	0.80
28	9.1454	8.8465	8.5496	-0.84	0.83
29	8.7942	8.4964	8.2013	-0.87	0.86
30	8.4583	8.1621	7.8691	-0.91	0.90

31	8.1371	7.8428	7.5522	-0.95	0.93
32	7.8299	7.5377	7.2498	-0.98	0.97
33	7.5359	7.2461	6.9611	-1.02	1.00
34	7.2546	6.9673	6.6854	-1.06	1.04
35	6.9852	6.7008	6.4222	-1.10	1.07
36	6.7273	6.4459	6.1707	-1.13	1.11
37	6.4803	6.2021	5.9304	-1.17	1.14
38	6.2437	5.9687	5.7007	-1.21	1.18
39	6.0170	5.7454	5.4812	-1.25	1.22
40	5.7997	5.5316	5.2712	-1.29	1.25
41	5.5914	5.3269	5.0704	-1.33	1.29
42	5.3916	5.1308	4.8783	-1.37	1.33
43	5.2001	4.9430	4.6944	-1.41	1.36
44	5.0163	4.7630	4.5185	-1.45	1.40
45	4.8400	4.5905	4.3500	-1.49	1.44
46	4.6708	4.4252	4.1887	-1.53	1.47
47	4.5083	4.2666	4.0342	-1.57	1.51
48	4.3524	4.1145	3.8862	-1.61	1.55
49	4.2026	3.9686	3.7443	-1.65	1.59
50	4.0588	3.8287	3.6084	-1.70	1.62
51	3.9206	3.6943	3.4780	-1.74	1.66
52	3.7878	3.5654	3.3531	-1.78	1.70
53	3.6601	3.4416	3.2332	-1.82	1.74
54	3.5374	3.3227	3.1183	-1.87	1.78
55	3.4195	3.2085	3.0079	-1.91	1.82
56	3.3060	3.0989	2.9021	-1.95	1.85
57	3.1969	2.9935	2.8005	-2.00	1.89
58	3.0919	2.8922	2.7029	-2.04	1.93
59	2.9909	2.7948	2.6092	-2.08	1.97
60	2.8936	2.7012	2.5193	-2.13	2.01
61	2.8000	2.6112	2.4328	-2.17	2.05
62	2.7099	2.5246	2.3498	-2.22	2.09
63	2.6232	2.4413	2.2700	-2.26	2.13
64	2.5396	2.3611	2.1932	-2.31	2.17
65	2.4591	2.2840	2.1195	-2.36	2.21
66	2.3815	2.2098	2.0486	-2.40	2.25
67	2.3068	2.1383	1.9803	-2.45	2.29
68	2.2347	2.0695	1.9147	-2.49	2.34
69	2.1652	2.0032	1.8516	-2.54	2.38
70	2.0983	1.9393	1.7908	-2.59	2.42
71	2.0337	1.8778	1.7324	-2.63	2.46
72	1.9714	1.8186	1.6761	-2.68	2.50
73	1.9113	1.7614	1.6219	-2.73	2.54
74	1.8533	1.7064	1.5697	-2.78	2.58
75	1.7974	1.6533	1.5194	-2.83	2.63

76	1.7434	1.6021	1.4710	-2.88	2.67
77	1.6913	1.5528	1.4243	-2.92	2.71
78	1.6409	1.5051	1.3794	-2.97	2.75
79	1.5923	1.4592	1.3360	-3.02	2.80
80	1.5454	1.4149	1.2942	-3.07	2.84
81	1.5000	1.3721	1.2540	-3.12	2.88
82	1.4562	1.3308	1.2151	-3.17	2.93
83	1.4139	1.2910	1.1776	-3.22	2.97
84	1.3730	1.2525	1.1415	-3.27	3.01
85	1.3335	1.2153	1.1066	-3.32	3.06
86	1.2953	1.1794	1.0730	-3.38	3.10
87	1.2583	1.1448	1.0405	-3.43	3.15
88	1.2226	1.1113	1.0092	-3.48	3.19
89	1.1880	1.0789	0.9789	-3.53	3.24
90	1.1546	1.0476	0.9497	-3.58	3.28
91	1.1223	1.0174	0.9215	-3.64	3.33
92	1.0910	0.9882	0.8942	-3.69	3.37
93	1.0607	0.9599	0.8679	-3.74	3.42
94	1.0314	0.9326	0.8424	-3.80	3.46
95	1.0030	0.9061	0.8179	-3.85	3.51
96	0.9756	0.8806	0.7941	-3.90	3.55
97	0.9490	0.8558	0.7711	-3.96	3.60
98	0.9232	0.8319	0.7489	-4.01	3.64
99	0.8983	0.8088	0.7275	-4.07	3.69
100	0.8741	0.7863	0.7067	-4.12	3.74
101	0.8507	0.7646	0.6867	-4.18	3.78
102	0.8281	0.7436	0.6672	-4.23	3.83
103	0.8061	0.7233	0.6484	-4.29	3.88
104	0.7848	0.7036	0.6303	-4.34	3.92
105	0.7641	0.6845	0.6127	-4.40	3.97
106	0.7441	0.6661	0.5957	-4.46	4.02
107	0.7247	0.6482	0.5792	-4.51	4.07
108	0.7059	0.6308	0.5632	-4.57	4.12
109	0.6877	0.6140	0.5478	-4.63	4.16
110	0.6700	0.5977	0.5328	-4.69	4.21
111	0.6528	0.5820	0.5183	-4.74	4.26
112	0.6361	0.5667	0.5043	-4.80	4.31
113	0.6200	0.5518	0.4907	-4.86	4.36
114	0.6043	0.5374	0.4775	-4.92	4.41
115	0.5891	0.5235	0.4648	-4.98	4.45
116	0.5743	0.5100	0.4524	-5.04	4.50
117	0.5600	0.4968	0.4404	-5.10	4.55
118	0.5460	0.4841	0.4288	-5.16	4.60
119	0.5325	0.4717	0.4175	-5.22	4.65
120	0.5194	0.4597	0.4066	-5.28	4.70

## 5.4.2 Outdoor Unit

### Ambient Sensor, Suction Sensor, Defrosting Sensor

R25°C=10K $\Omega$   $\pm$ 3%

B25°C/50°C=3700K $\pm$ 3%

Temp.(°C)	Max.(K $\Omega$ )	Normal(K $\Omega$ )	Min.(K $\Omega$ )	Tolerance(°C)	
-30	165.2170	147.9497	132.3678	-1.94	1.75
-29	155.5754	139.5600	125.0806	-1.93	1.74
-28	146.5609	131.7022	118.2434	-1.91	1.73
-27	138.1285	124.3392	111.8256	-1.89	1.71
-26	130.2371	117.4366	105.7989	-1.87	1.70
-25	122.8484	110.9627	100.1367	-1.85	1.69
-24	115.9272	104.8882	94.8149	-1.83	1.67
-23	109.4410	99.1858	89.8106	-1.81	1.66
-22	103.3598	93.8305	85.1031	-1.80	1.64
-21	97.6556	88.7989	80.6728	-1.78	1.63
-20	92.3028	84.0695	76.5017	-1.76	1.62
-19	87.2775	79.6222	72.5729	-1.74	1.60
-18	82.5577	75.4384	68.8710	-1.72	1.59
-17	78.1230	71.5010	65.3815	-1.70	1.57
-16	73.9543	67.7939	62.0907	-1.68	1.55
-15	70.0342	64.3023	58.9863	-1.66	1.54
-14	66.3463	61.0123	56.0565	-1.64	1.52
-13	62.8755	57.9110	53.2905	-1.62	1.51
-12	59.6076	54.9866	50.6781	-1.60	1.49
-11	56.5296	52.2278	48.2099	-1.58	1.47
-10	53.6294	49.6244	45.8771	-1.56	1.46
-9	50.8956	47.1666	43.6714	-1.54	1.44
-8	48.3178	44.8454	41.5851	-1.51	1.42
-7	45.8860	42.6525	39.6112	-1.49	1.40
-6	43.5912	40.5800	37.7429	-1.47	1.39
-5	41.4249	38.6207	35.9739	-1.45	1.37
-4	39.3792	36.7676	34.2983	-1.43	1.35
-3	37.4465	35.0144	32.7108	-1.41	1.33
-2	35.6202	33.3552	31.2062	-1.38	1.31
-1	33.8936	31.7844	29.7796	-1.36	1.29
0	32.2608	30.2968	28.4267	-1.34	1.28
1	30.7162	28.8875	27.1431	-1.32	1.26
2	29.2545	27.5519	25.9250	-1.29	1.24
3	27.8708	26.2858	24.7686	-1.27	1.22
4	26.5605	25.0851	23.6704	-1.25	1.20
5	25.3193	23.9462	22.6273	-1.23	1.18
6	24.1432	22.8656	21.6361	-1.20	1.16
7	23.0284	21.8398	20.6939	-1.18	1.14
8	21.9714	20.8659	19.7982	-1.15	1.12
9	20.9688	19.9409	18.9463	-1.13	1.09

10	20.0176	19.0621	18.1358	-1.11	1.07
11	19.1149	18.2270	17.3646	-1.08	1.05
12	18.2580	17.4331	16.6305	-1.06	1.03
13	17.4442	16.6782	15.9315	-1.03	1.01
14	16.6711	15.9601	15.2657	-1.01	0.99
15	15.9366	15.2770	14.6315	-0.98	0.96
16	15.2385	14.6268	14.0271	-0.96	0.94
17	14.5748	14.0079	13.4510	-0.93	0.92
18	13.9436	13.4185	12.9017	-0.91	0.90
19	13.3431	12.8572	12.3778	-0.88	0.87
20	12.7718	12.3223	11.8780	-0.86	0.85
21	12.2280	11.8126	11.4011	-0.83	0.83
22	11.7102	11.3267	10.9459	-0.81	0.80
23	11.2172	10.8634	10.5114	-0.78	0.78
24	10.7475	10.4216	10.0964	-0.75	0.75
25	10.3000	10.0000	9.7000	-0.75	0.75
26	9.8975	9.5974	9.2980	-0.76	0.76
27	9.5129	9.2132	8.9148	-0.80	0.80
28	9.1454	8.8465	8.5496	-0.84	0.83
29	8.7942	8.4964	8.2013	-0.87	0.86
30	8.4583	8.1621	7.8691	-0.91	0.90
31	8.1371	7.8428	7.5522	-0.95	0.93
32	7.8299	7.5377	7.2498	-0.98	0.97
33	7.5359	7.2461	6.9611	-1.02	1.00
34	7.2546	6.9673	6.6854	-1.06	1.04
35	6.9852	6.7008	6.4222	-1.10	1.07
36	6.7273	6.4459	6.1707	-1.13	1.11
37	6.4803	6.2021	5.9304	-1.17	1.14
38	6.2437	5.9687	5.7007	-1.21	1.18
39	6.0170	5.7454	5.4812	-1.25	1.22
40	5.7997	5.5316	5.2712	-1.29	1.25
41	5.5914	5.3269	5.0704	-1.33	1.29
42	5.3916	5.1308	4.8783	-1.37	1.33
43	5.2001	4.9430	4.6944	-1.41	1.36
44	5.0163	4.7630	4.5185	-1.45	1.40
45	4.8400	4.5905	4.3500	-1.49	1.44
46	4.6708	4.4252	4.1887	-1.53	1.47
47	4.5083	4.2666	4.0342	-1.57	1.51
48	4.3524	4.1145	3.8862	-1.61	1.55
49	4.2026	3.9686	3.7443	-1.65	1.59
50	4.0588	3.8287	3.6084	-1.70	1.62
51	3.9206	3.6943	3.4780	-1.74	1.66
52	3.7878	3.5654	3.3531	-1.78	1.70
53	3.6601	3.4416	3.2332	-1.82	1.74
54	3.5374	3.3227	3.1183	-1.87	1.78

55	3.4195	3.2085	3.0079	-1.91	1.82
56	3.3060	3.0989	2.9021	-1.95	1.85
57	3.1969	2.9935	2.8005	-2.00	1.89
58	3.0919	2.8922	2.7029	-2.04	1.93
59	2.9909	2.7948	2.6092	-2.08	1.97
60	2.8936	2.7012	2.5193	-2.13	2.01
61	2.8000	2.6112	2.4328	-2.17	2.05
62	2.7099	2.5246	2.3498	-2.22	2.09
63	2.6232	2.4413	2.2700	-2.26	2.13
64	2.5396	2.3611	2.1932	-2.31	2.17
65	2.4591	2.2840	2.1195	-2.36	2.21
66	2.3815	2.2098	2.0486	-2.40	2.25
67	2.3068	2.1383	1.9803	-2.45	2.29
68	2.2347	2.0695	1.9147	-2.49	2.34
69	2.1652	2.0032	1.8516	-2.54	2.38
70	2.0983	1.9393	1.7908	-2.59	2.42
71	2.0337	1.8778	1.7324	-2.63	2.46
72	1.9714	1.8186	1.6761	-2.68	2.50
73	1.9113	1.7614	1.6219	-2.73	2.54
74	1.8533	1.7064	1.5697	-2.78	2.58
75	1.7974	1.6533	1.5194	-2.83	2.63
76	1.7434	1.6021	1.4710	-2.88	2.67
77	1.6913	1.5528	1.4243	-2.92	2.71
78	1.6409	1.5051	1.3794	-2.97	2.75
79	1.5923	1.4592	1.3360	-3.02	2.80
80	1.5454	1.4149	1.2942	-3.07	2.84
81	1.5000	1.3721	1.2540	-3.12	2.88
82	1.4562	1.3308	1.2151	-3.17	2.93
83	1.4139	1.2910	1.1776	-3.22	2.97
84	1.3730	1.2525	1.1415	-3.27	3.01
85	1.3335	1.2153	1.1066	-3.32	3.06
86	1.2953	1.1794	1.0730	-3.38	3.10
87	1.2583	1.1448	1.0405	-3.43	3.15
88	1.2226	1.1113	1.0092	-3.48	3.19
89	1.1880	1.0789	0.9789	-3.53	3.24
90	1.1546	1.0476	0.9497	-3.58	3.28
91	1.1223	1.0174	0.9215	-3.64	3.33
92	1.0910	0.9882	0.8942	-3.69	3.37
93	1.0607	0.9599	0.8679	-3.74	3.42
94	1.0314	0.9326	0.8424	-3.80	3.46
95	1.0030	0.9061	0.8179	-3.85	3.51
96	0.9756	0.8806	0.7941	-3.90	3.55
97	0.9490	0.8558	0.7711	-3.96	3.60
98	0.9232	0.8319	0.7489	-4.01	3.64
99	0.8983	0.8088	0.7275	-4.07	3.69

100	0.8741	0.7863	0.7067	-4.12	3.74
101	0.8507	0.7646	0.6867	-4.18	3.78
102	0.8281	0.7436	0.6672	-4.23	3.83
103	0.8061	0.7233	0.6484	-4.29	3.88
104	0.7848	0.7036	0.6303	-4.34	3.92
105	0.7641	0.6845	0.6127	-4.40	3.97
106	0.7441	0.6661	0.5957	-4.46	4.02
107	0.7247	0.6482	0.5792	-4.51	4.07
108	0.7059	0.6308	0.5632	-4.57	4.12
109	0.6877	0.6140	0.5478	-4.63	4.16
110	0.6700	0.5977	0.5328	-4.69	4.21
111	0.6528	0.5820	0.5183	-4.74	4.26
112	0.6361	0.5667	0.5043	-4.80	4.31
113	0.6200	0.5518	0.4907	-4.86	4.36
114	0.6043	0.5374	0.4775	-4.92	4.41
115	0.5891	0.5235	0.4648	-4.98	4.45
116	0.5743	0.5100	0.4524	-5.04	4.50
117	0.5600	0.4968	0.4404	-5.10	4.55
118	0.5460	0.4841	0.4288	-5.16	4.60
119	0.5325	0.4717	0.4175	-5.22	4.65
120	0.5194	0.4597	0.4066	-5.28	4.70

## Discharging Sensor

R80°C=50KΩ ± 3%

B25/80°C=4450K ± 3%

Temp.((°C))	Max.(KΩ)	Normal(KΩ)	Min.(KΩ)	Tolerance(°C)	
-30	14646.0505	12061.7438	9924.4999	-2.96	2.45
-29	13654.1707	11267.8730	9290.2526	-2.95	2.44
-28	12735.8378	10531.3695	8700.6388	-2.93	2.44
-27	11885.1336	9847.7240	8152.2338	-2.92	2.43
-26	11096.6531	9212.8101	7641.8972	-2.91	2.42
-25	10365.4565	8622.8491	7166.7474	-2.90	2.42
-24	9687.0270	8074.3787	6724.1389	-2.88	2.41
-23	9057.2314	7564.2244	6311.6413	-2.87	2.41
-22	8472.2852	7089.4741	5927.0206	-2.86	2.40
-21	7928.7217	6647.4547	5568.2222	-2.84	2.39
-20	7423.3626	6235.7109	5233.3554	-2.83	2.39
-19	6953.2930	5851.9864	4920.6791	-2.82	2.38
-18	6515.8375	5494.2064	4628.5894	-2.80	2.37
-17	6108.5393	5160.4621	4355.6078	-2.79	2.37
-16	5729.1413	4848.9963	4100.3708	-2.77	2.36
-15	5375.5683	4558.1906	3861.6201	-2.76	2.35
-14	5045.9114	4286.5535	3638.1938	-2.75	2.34
-13	4738.4141	4032.7098	3429.0191	-2.73	2.34
-12	4451.4586	3795.3910	3233.1039	-2.72	2.33
-11	4183.5548	3573.4260	3049.5312	-2.70	2.32
-10	3933.3289	3365.7336	2877.4527	-2.69	2.31
-9	3699.5139	3171.3148	2716.0828	-2.67	2.30
-8	3480.9407	2989.2460	2564.6945	-2.66	2.29
-7	3276.5302	2818.6731	2422.6139	-2.64	2.28
-6	3085.2854	2658.8058	2289.2164	-2.63	2.28
-5	2906.2851	2508.9126	2163.9230	-2.61	2.27
-4	2738.6777	2368.3158	2046.1961	-2.60	2.26
-3	2581.6752	2236.3876	1935.5371	-2.58	2.25
-2	2434.5487	2112.5459	1831.4826	-2.56	2.24
-1	2296.6230	1996.2509	1733.6024	-2.55	2.23
0	2167.2730	1887.0018	1641.4966	-2.53	2.22
1	2045.9191	1784.3336	1554.7931	-2.52	2.21
2	1932.0242	1687.8144	1473.1460	-2.50	2.20
3	1825.0899	1597.0431	1396.2333	-2.48	2.19
4	1724.6540	1511.6468	1323.7551	-2.47	2.17
5	1630.2870	1431.2787	1255.4324	-2.45	2.16
6	1541.5904	1355.6163	1191.0048	-2.43	2.15
7	1458.1938	1284.3593	1130.2298	-2.41	2.14
8	1379.7528	1217.2282	1072.8813	-2.40	2.13
9	1305.9472	1153.9626	1018.7481	-2.38	2.12
10	1236.4792	1094.3200	967.6334	-2.36	2.11



11	1171.0715	1038.0743	919.3533	-2.35	2.09
12	1109.4661	985.0146	873.7359	-2.33	2.08
13	1051.4226	934.9440	830.6210	-2.31	2.07
14	996.7169	887.6792	789.8583	-2.29	2.06
15	945.1404	843.0486	751.3077	-2.27	2.04
16	896.4981	800.8922	714.8380	-2.26	2.03
17	850.6086	761.0603	680.3265	-2.24	2.02
18	807.3024	723.4134	647.6580	-2.22	2.00
19	766.4212	687.8205	616.7252	-2.20	1.99
20	727.8172	654.1596	587.4271	-2.18	1.98
21	691.3524	622.3161	559.6694	-2.16	1.96
22	656.8979	592.1831	533.3634	-2.14	1.95
23	624.3328	563.6604	508.4261	-2.12	1.93
24	593.5446	536.6540	484.7796	-2.10	1.92
25	564.4275	511.0760	462.3510	-2.09	1.90
26	536.9865	486.9352	441.1516	-2.07	1.89
27	511.0105	464.0500	421.0258	-2.05	1.87
28	486.4151	442.3499	401.9146	-2.03	1.86
29	463.1208	421.7683	383.7626	-2.01	1.84
30	441.0535	402.2430	366.5175	-1.99	1.83
31	420.1431	383.7151	350.1301	-1.97	1.81
32	400.3242	366.1295	334.5542	-1.95	1.80
33	381.5350	349.4341	319.7460	-1.93	1.78
34	363.7176	333.5801	305.6645	-1.90	1.76
35	346.8176	318.5216	292.2709	-1.88	1.75
36	330.7839	304.2151	279.5286	-1.86	1.73
37	315.5682	290.6199	267.4031	-1.84	1.71
38	301.1254	277.6976	255.8620	-1.82	1.70
39	287.4128	265.4119	244.8745	-1.80	1.68
40	274.3905	253.7288	234.4118	-1.78	1.66
41	262.0206	242.6161	224.4465	-1.76	1.64
42	250.2676	232.0436	214.9529	-1.74	1.63
43	239.0983	221.9825	205.9065	-1.71	1.61
44	228.4809	212.4060	197.2844	-1.69	1.59
45	218.3860	203.2887	189.0648	-1.67	1.57
46	208.7855	194.6066	181.2273	-1.65	1.55
47	199.6531	186.3369	173.7524	-1.63	1.54
48	190.9639	178.4584	166.6217	-1.60	1.52
49	182.6945	170.9508	159.8181	-1.58	1.50
50	174.8228	163.7951	153.3249	-1.56	1.48
51	167.3280	156.9733	147.1268	-1.53	1.46
52	160.1904	150.4683	141.2090	-1.51	1.44
53	153.3914	144.2641	135.5577	-1.49	1.42
54	146.9136	138.3454	130.1598	-1.47	1.40
55	140.7403	132.6980	125.0027	-1.44	1.38

56	134.8559	127.3081	120.0746	-1.42	1.36
57	129.2457	122.1630	115.3645	-1.40	1.34
58	123.8956	117.2504	110.8618	-1.37	1.32
59	118.7926	112.5589	106.5564	-1.35	1.30
60	113.9241	108.0776	102.4388	-1.32	1.28
61	109.2784	103.7961	98.5000	-1.30	1.26
62	104.8443	99.7046	94.7315	-1.28	1.23
63	100.6112	95.7939	91.1253	-1.25	1.21
64	96.5692	92.0553	87.6735	-1.23	1.19
65	92.7088	88.4805	84.3690	-1.20	1.17
66	89.0211	85.0614	81.2048	-1.18	1.15
67	85.4976	81.7908	78.1744	-1.15	1.12
68	82.1303	78.6615	75.2715	-1.13	1.10
69	78.9116	75.6668	72.4902	-1.10	1.08
70	75.8343	72.8004	69.8249	-1.08	1.06
71	72.8916	70.0561	67.2703	-1.05	1.03
72	70.0770	67.4283	64.8213	-1.03	1.01
73	67.3844	64.9115	62.4731	-1.00	0.99
74	64.8080	62.5006	60.2211	-0.98	0.96
75	62.3423	60.1906	58.0609	-0.95	0.94
76	59.9821	57.9770	55.9885	-0.92	0.92
77	57.7223	55.8552	53.9998	-0.90	0.89
78	55.5583	53.8210	52.0912	-0.87	0.87
79	53.4856	51.8706	50.2591	-0.85	0.84
80	51.5000	50.0000	48.5000	-0.85	0.84
81	49.7063	48.2057	46.7083	-0.85	0.85
82	47.9835	46.4842	44.9911	-0.89	0.89
83	46.3286	44.8323	43.3452	-0.93	0.92
84	44.7385	43.2468	41.7672	-0.96	0.95
85	43.2105	41.7248	40.2540	-1.00	0.99
86	41.7386	40.2604	38.7996	-1.03	1.02
87	40.3241	38.8545	37.4048	-1.07	1.06
88	38.9643	37.5045	36.0668	-1.11	1.09
89	37.6569	36.2078	34.7831	-1.14	1.13
90	36.3996	34.9622	33.5513	-1.18	1.16
91	35.1903	33.7653	32.3689	-1.22	1.19
92	34.0269	32.6151	31.2338	-1.26	1.23
93	32.9075	31.5096	30.1438	-1.30	1.27
94	31.8302	30.4467	29.0970	-1.33	1.30
95	30.7933	29.4246	28.0915	-1.37	1.34
96	29.7950	28.4417	27.1254	-1.41	1.37
97	28.8337	27.4961	26.1970	-1.45	1.41
98	27.9078	26.5864	25.3048	-1.49	1.44
99	27.0160	25.7110	24.4470	-1.53	1.48
100	26.1569	24.8685	23.6222	-1.57	1.52

101	25.3290	24.0574	22.8291	-1.61	1.55
102	24.5311	23.2765	22.0662	-1.65	1.59
103	23.7620	22.5245	21.3323	-1.69	1.63
104	23.0205	21.8002	20.6261	-1.73	1.66
105	22.3055	21.1025	19.9465	-1.77	1.70
106	21.6159	20.4303	19.2924	-1.81	1.74
107	20.9508	19.7825	18.6626	-1.85	1.77
108	20.3091	19.1582	18.0563	-1.89	1.81
109	19.6899	18.5564	17.4723	-1.93	1.85
110	19.0924	17.9761	16.9098	-1.98	1.89
111	18.5157	17.4166	16.3680	-2.02	1.93
112	17.9590	16.8769	15.8458	-2.06	1.96
113	17.4214	16.3564	15.3427	-2.10	2.00
114	16.9023	15.8542	14.8577	-2.15	2.04
115	16.4010	15.3696	14.3902	-2.19	2.08
116	15.9167	14.9020	13.9394	-2.23	2.12
117	15.4489	14.4506	13.5047	-2.27	2.16
118	14.9968	14.0149	13.0855	-2.32	2.19
119	14.5599	13.5942	12.6811	-2.36	2.23
120	14.1376	13.1879	12.2909	-2.41	2.27
121	13.7294	12.7955	11.9144	-2.45	2.31
122	13.3347	12.4165	11.5510	-2.50	2.35
123	12.9531	12.0503	11.2003	-2.54	2.39
124	12.5840	11.6965	10.8617	-2.58	2.43
125	12.2270	11.3545	10.5348	-2.63	2.47
126	11.8817	11.0240	10.2191	-2.68	2.51
127	11.5475	10.7046	9.9142	-2.72	2.55
128	11.2242	10.3957	9.6197	-2.77	2.59
129	10.9112	10.0970	9.3352	-2.81	2.63
130	10.6084	9.8082	9.0602	-2.86	2.67
131	10.3151	9.5288	8.7945	-2.91	2.71
132	10.0312	9.2586	8.5378	-2.95	2.75
133	9.7563	8.9971	8.2895	-3.00	2.80
134	9.4901	8.7441	8.0495	-3.05	2.84
135	9.2322	8.4993	7.8175	-3.09	2.88
136	8.9824	8.2623	7.5931	-3.14	2.92
137	8.7404	8.0329	7.3760	-3.19	2.96
138	8.5059	7.8108	7.1660	-3.24	3.00
139	8.2787	7.5958	6.9629	-3.29	3.04
140	8.0584	7.3875	6.7664	-3.33	3.09

## 6. System Configuration

### 6.1 System Configuration

After the installation and test operation of the room air conditioner have been completed, it should be operated and handled as described below. Every user would like to know the correct method of operation of the room air conditioner, to check if it is capable of cooling (or heating) well, and to know a clever method of using it. In order to meet this expectation of the users, giving sufficient explanations taking enough time can be said to reduce about 80% of the requests for servicing. However good the installation work is and however good the functions are, the customer may blame either the room air conditioner or its installation work because of improper handling. The installation work and handing over of the unit can only be considered to have been completed when its handling has been explained to the user without using technical terms but giving full knowledge of the equipment.

### 6.2 Instruction

# Parts and Functions

## Indoor Unit

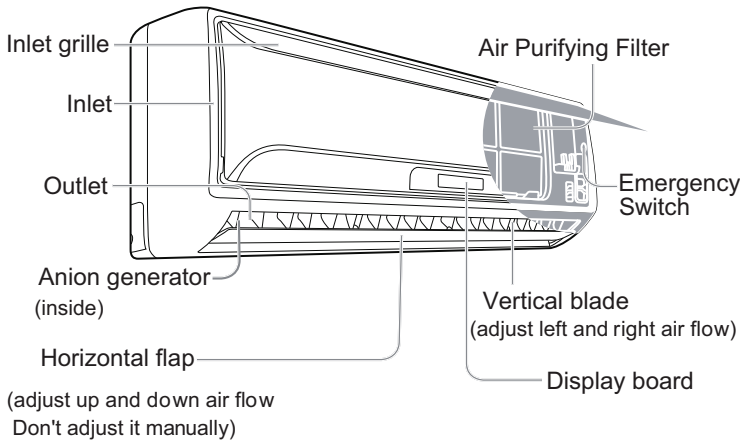

Actual inlet grille may vary from the one shown in the manual according to the product purchased

### Display board for 12:

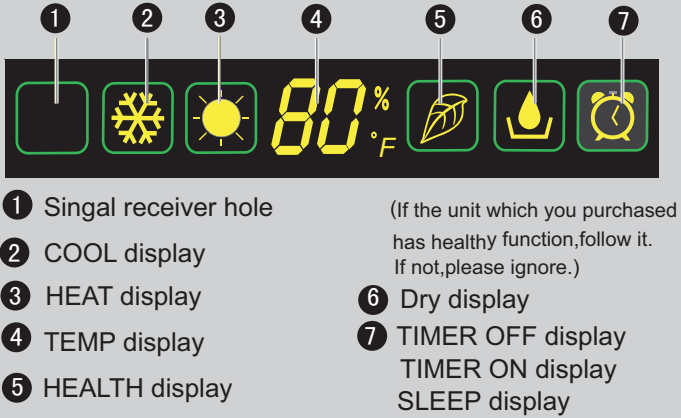

### Display board for 18:

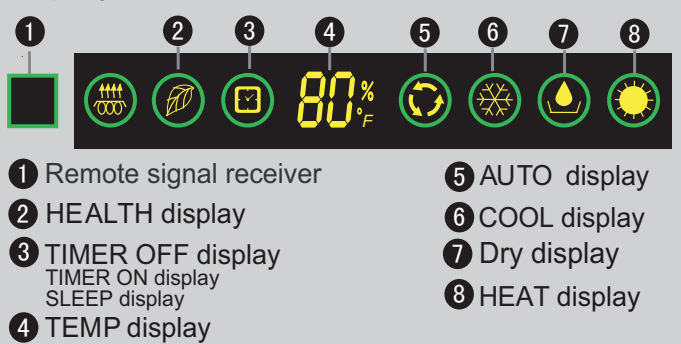

## Outdoor Unit

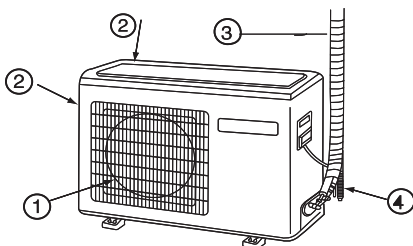

- ① OUTLET
- ② INLET
- ③ CONNECTING PIPING AND ELECTRICAL WIRING
- ④ DRAIN HOSE

## Remote controller

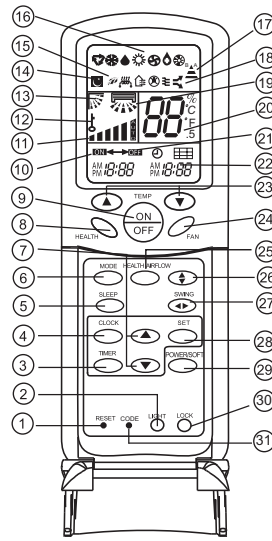

- 8. HEALTH button
- 9. ON/OFF button
- 10. TIMER ON display
- 11. FAN SPEED display



- 12. LOCK display
- 13. SWING UP/DOWN display
- 14. SLEEP display
- 15. HEALTH display
- 16. Operation mode display

Operation mode	AUTO	COOL	DRY	HEAT	FAN
Remote controller					

- 17. Singal sending display
- 18. POWER/SOFT display
- 19. Left/right air flow display
- 20. TEMP display
- 21. TIMER OFF display
- 22. TIMER display
- 23. TEMP button
- 24. FAN button
- 25. HEALTH AIRFLOW button
- 26. SWING UP/DOWN button
- 27. SWING LEFT/RIGHT button
- 28. SET button
- 29. POWER/SOFT button
- 30. LOCK button  
If pressed, the other buttons will be disabled. Press it once again, lock will be cancelled.
- 31. CODE button  
Use to select CODE A or B which will be displayed on LCD. Please select A without special explanation.

- 1. RESET button  
When the remote controller appears abnormal, use a sharp pointed article to press this button to reset the remote controller normal.
- 2. LIGHT button  
Control the lightening and extinguishing of the indoor LED display board.
- 3. TIMER button
- 4. CLOCK button
- 5. SLEEP button
- 6. MODE button
- 7. HOUR button

NOTE:  
Cooling only unit do not have functions and displays related with heating.

## Loading of the battery

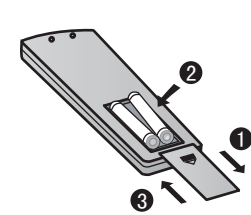

- 1 Remove the battery cover;
- 2 Load the batteries as illustrated. 2 R-03 batteries, resetting key (cylinder);
- 3 Be sure that the loading is in line with the "+" and "-";
- 4 Load the battery, then put on the cover again.

- Note:
- The distance between the signal transmission head and the receiver hole should be within 7m without any obstacle as well.
  - When electronic-started type fluorescent lamp or change-over type fluorescent lamp or wireless telephone is installed in the room, the receiver is apt to be disturbed in receiving the signals, so the distance to the indoor unit should be shorter.
  - Full display or unclear display during operation indicates the batteries have been used up. Please change batteries.
  - If the remote controller can't run normally during operation, please remove the batteries and reload several minutes later.

Hint:  
Remove the batteries in case unit won't be in usage for a long period. If there are any display after taking-out, just need to press reset key.

# Operation

## Clock set

Press CLOCK button, "AM" or "PM" flashes.  
Press  $\Delta$  or  $\nabla$  to set correct time. Each press will increase or decrease 1min. If the button is kept pressed, time will change quickly. After time setting is confirmed, press SET, "AM" and "PM" stop flashing, while clock starts working.



## Base Operation

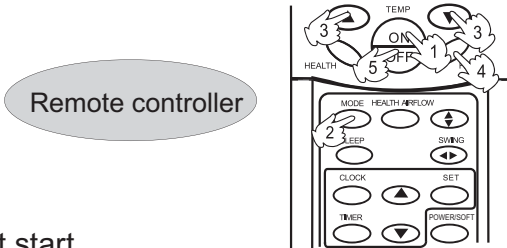

### 1. Unit start

Press ON/OFF on the remote controller, unit starts.

### 2. Select operation mode

Press MODE button. For each press, operation mode changes as follows:  
Remote controller:



### 3. Select temp. setting

Press  $\Delta$  /  $\nabla$  button

- $\Delta$  Every time the button is pressed, temp. setting increase 2°F, if kept depressed, it will increase rapidly
- $\nabla$  Every time the button is pressed, temp. setting decrease 2°F, if kept depressed, it will decrease rapidly

Select a desired temperature.

### 4. Fan speed selection

Press FAN button. For each press, fan speed changes as follows:

Remote controller:



Air conditioner is running under displayed fan speed.  
When FAN is set to AUTO, the air conditioner automatically adjusts the fan speed according to room temperature.

Operation Mode	Display Board	Remote Controller	Note
AUTO	For 12:		Under the mode of auto operation, air conditioner will automatically select Cool or Heat operation according to room temperature. When FAN is set to AUTO, the air conditioner automatically adjusts the fan speed according to room temperature.
	For 18:		
COOL	For 12:		
	For 18:		
DRY	For 12:		In DRY mode, when room temperature becomes lower than temp. setting about +35°F, unit will run intermittently at LOW speed regardless of FAN setting.
	For 18:		
HEAT	For 12:		
	For 18:		
FAN	nothing		In FAN operation mode, the unit will not operate in COOL or HEAT mode but only in FAN mode. AUTO is not available in FAN mode. And temp. setting is disabled. In FAN mode, SLEEP operation is not available.

## Emergency operation and test operation

### Emergency Operation:

Use this operation only when the remote controller is defective or lost.

### When the emergency operation switch is pressed, the "Pi" sound is heard once, which means the start of this operation.

In this operation, the system automatically selects the operation modes, cooling or fan or heat, according to the room temperature.

When machine is running in emergency, the set value of temperature and wind speed couldn't be altered; meanwhile, it can't operate for dehumidifying or under timing mode.

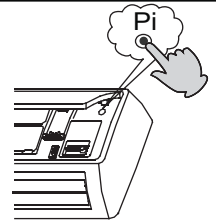

### Test operation:

Test operation switch is the same as emergency switch.

Use this switch in the test operation when the room temperature is below 60°F, do not use it in the normal operation.

Continue to press the test operation switch for more than 5 seconds. After you hear the "Pi" sound twice, release your finger from the switch: the cooling operation starts with the air flow speed "Hi".

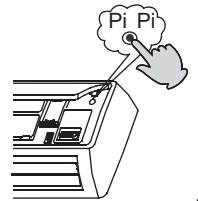

## Air Flow D...

### 1. Status display of air sending

Vertical flap

Pos.1 Pos.2 Pos.3

Pos.4 Pos.5 Pos.6 (Auto swing)

### 2. Left and right air flow adjustment (manual)

Move the vertical blade by a knob on air conditioner to adjust left and right direction referring to Fig.

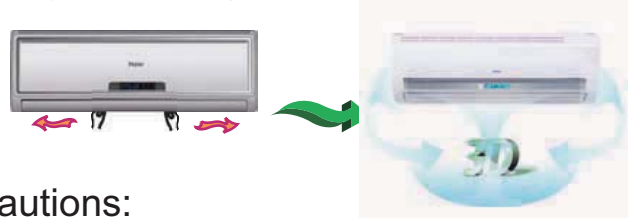

### Cautions:

- When adjusting the flap by hand, turn off the unit.
- When humidity is high, condensate water might occur at air outlet if all vertical louvers are adjusted to left or right.
- It is advisable not to keep horizontal flap at downward position for a long time in COOL or DRY mode, otherwise, condensate water might occur.

### Note:

When restart after remote turning off, the remote controller will automatically memorize the previous set swing position.

# Operation

## Sleep Operation

Before going to bed, you can simply press the SLEEP button and unit will operate in SLEEP mode and bring you a sound sleep.



### Use of SLEEP function

After the unit starts, set the operation status, then press SLEEP button before which the clock must be adjusted and time being set.

### Operation Mode

#### 1. In COOL, DRY mode

1 hours after SLEEP mode starts, temp. will become about 2°F higher than temp. setting. After another 1 hours, temp. rises about 2°F further. The unit will run for further 6 hours then stops. Temp. is higher than temp. setting so that room temperature won't be too low for your sleep.

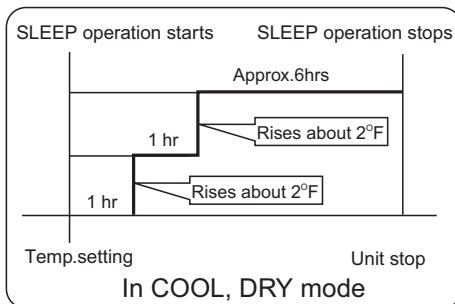

#### 2. In HEAT mode

1 hours after SLEEP mode starts, temp will become about 4°F lower than temp. setting. After another 1 hours, temp decrease about 4°F further. After more another 3 hours, temp. rises about 2°F further. The unit will run for further 3 hours then stops. Temp. is lower than temp. setting so that room temperature won't be too high for your sleep.

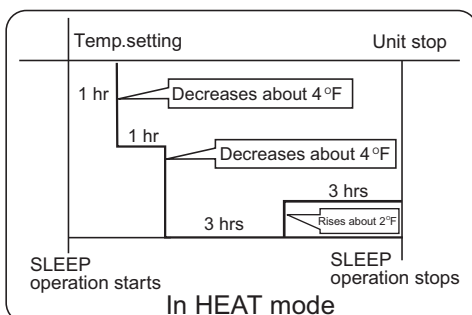

#### 3. In AUTO mode

The unit operates in corresponding sleep mode adapted to the automatically selected operation mode.

#### 4. In FAN mode

It has no SLEEP function.

#### 5. Set the wind speed change when sleeping

If the wind speed is high or middle before setting for the sleep, set for lowering the wind speed after sleeping.

If it is low wind, no change.

#### 6. Note to the power failure resume:

press the sleep button ten times in five seconds and enter this function after hearing four sounds. And press the sleep button ten times within five seconds and leave this function after hearing two sounds.

#### NOTE:

With the power failure resume, when setting the TIMER ON, TIMER OFF and TIMER ON/OFF, it's memorized as shutdown status when resuming after power out.

## POWER/SOFT Operation

### (1) POWER Operation

When you need rapid heating or cooling, you can use this function. In COOL mode, fan speed automatically takes high speed of AUTO fan mode. In HEAT mode, fan speed automatically takes medial speed of AUTO fan mode.

### (2) SOFT Operation

You can use this function when silence is needed for rest or reading. In SOFT operation mode, fan speed automatically takes low speed of AUTO fan mode.

#### Note:

During POWER operation, in rapid HEAT or COOL mode, the room will show inhomogeneous temperature distribution. Long period SOFT operation will cause effect of not too cool or not too warm.

To cancel POWER or SOFT operation

Press POWER/SOFT button again, POWER or SOFT disappears.

## HEALTH Operation



### Healthy Negative ion

The anion generator in the airconditioner can generate a lot of anion effectively balance the quantity of position and anion in the air and also to kill bacteria and speed up the dust sediment in the room and finally clean the air in the room.

# Operation

## Timer On/Off On-Off Operation

Set clock correctly before starting TIMER operation.

1. After unit starts, select your desired operation mode.
2. Press TIMER button to change TIMER mode. Every time the button is pressed, display changes as follows:  
Remote controller:



Then select your desired TIMER mode (TIMER ON or TIMER OFF or TIMER ON-OFF). "ON" or "OFF" will flash.

3. Press HOUR  $\blacktriangle$  /  $\blacktriangledown$  button to set time. It can be adjusted within 24 hours.
4. After setting correct time, press SET button to confirm "ON" or "OFF" on the remote controller stops flashing.
5. Cancel TIMER mode  
Just press TIMER button several times until TIMER mode disappears.

Hints:

After replacing batteries or a power failure happens, time setting should be reset.

Remote controller possesses memory function, when use TIMER mode next time, just press SET button after mode selecting if time setting is the same as previous one.

According to the Time setting sequence of TIMER ON or TIMER OFF, either Start-Stop or Stop-Start can be achieved.

## Health airflow Operation

1. Press ON/OFF to starting  
Setting the comfort work conditions.
2. The setting of health airflow function
  - 1). Press the button of health airflow,  $\text{☰}$  appears on the display. Horizontal airflow sending. Avoid the strong airflow blows direct to the body.
  - 2). Press the button of health airflow again,  $\text{☷}$  appears on the display. Downward airflow sending. Avoid the strong airflow blows direct to the body.
3. The cancel of the health airflow function  
Press the button of health airflow again, the unit goes on working under the condition before the setting of health airflow function.

Notice: Cannot pull direct the flap by hand. Otherwise, the grille will run incorrectly. If the grille is not run correctly, stop for a minute and then start, adjusting by remote controller.

Note:

1. After setting the health airflow function, the position grill is fixed.
2. In heating, it is better to select the  $\text{☷}$  mode.
3. In cooling, it is better to select the  $\text{☰}$  mode.
4. In cooling and dry, using the air conditioner for a long time under the high air humidity, a phenomenon falling drips of water occurs at the grille.

## IMPORTANT INFORMATION REGARDING THE REFRIGERANT USED

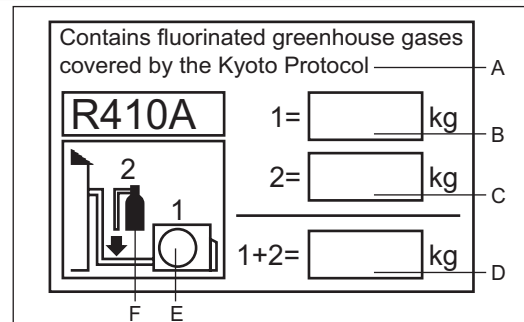

This product contains fluorinated greenhouse gases covered by the Kyoto Protocol. Do not vent into the atmosphere.

Refrigerant type: R410A

GWP\* value: 1975

GWP=global warming potential

Please fill in with indelible ink,

- 1 the factory refrigerant charge of the product
- 2 the additional refrigerant amount charged in the field and
- 1+2 the total refrigerant charge

on the refrigerant charge label supplied with the product. The filled out label must be adhered in the proximity of the product charging port (e.g. onto the inside of the stop value cover).

A contains fluorinated greenhouse gases covered by the Kyoto Protocol

B factory refrigerant charge of the product: see unit name plate

C additional refrigerant amount charged in the field

D total refrigerant charge







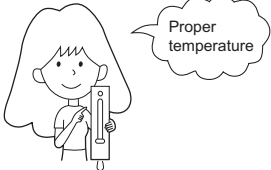
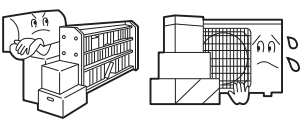

E outdoor unit

F refrigerant cylinder and manifold for charging

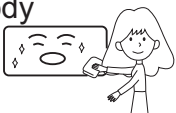
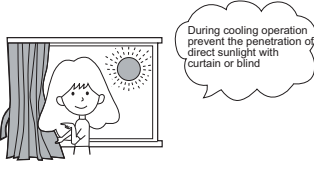
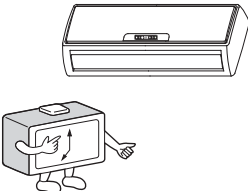

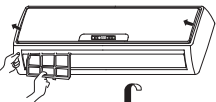

# Maintenance

## For Smart Use of The Air Conditioner

<p><b>Setting of proper room temperature</b></p> 	<p><b>Do not block the air inlet or outlet</b></p> 	<p><b>Remote Controller</b></p>  <p>Do not use water, wipe the controller with a dry cloth. Do not use glass cleaner or chemical cloth.</p>	<p><b>Indoor Body</b></p>  <p>Wipe the air conditioner by using a soft and dry cloth. For serious stains, use a neutral detergent diluted with water. Wring the water out of the cloth before wiping, then wipe off the detergent completely.</p>
<p><b>Close doors and windows during operation</b></p> 	<p><b>Use the timer effectively</b></p> 	<p><b>Do not use the following for cleaning</b></p>  <p>Gasoline, benzene, thinner or cleanser may damage the coating of the unit.</p>  <p>Hot water over 40°C (104°F) may cause discoloring or deformation.</p>	
<p><b>If the unit is not to be used for a long time, turn off the power supply main switch.</b></p> 	<p><b>Use the louvers effectively</b></p> 	<p><b>Air Filter cleaning</b></p> <ol style="list-style-type: none"> <li><b>1 Open the inlet grille by pulling it upward.</b></li> <li><b>2 Remove the filter.</b> Push up the filter's center tab slightly until it is released from the stopper, and remove the filter downward.</li> <li><b>3 Clean the filter.</b> Use a vacuum cleaner to remove dust, or wash the filter with water. After washing, dry the filter completely in the shade.</li> <li><b>4 Attach the filter.</b> Attach the filter correctly so that the "FRONT" indication is facing to the front. Make sure that the filter is completely fixed behind the stopper. If the right and left filters are not attached correctly, that may cause defects.</li> <li><b>5 Close the inlet grille.</b></li> </ol>  	

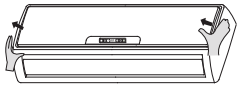
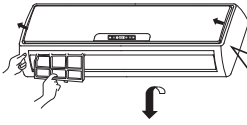
## Replacement of Air Purifying Filter

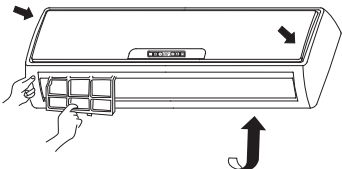
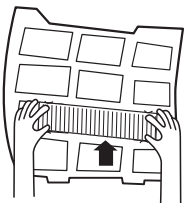
<p><b>1. Open the Inlet Grille</b> Prop up the inlet grille by using a small device named grille-support which located in the right side of the indoor unit.</p>  <p><b>2. Detach the standard air filter</b> Slide the knob slightly upward to release the filter, then withdraw it.</p>  <p>Detach old Air Purifying Filter</p> 	<p><b>4. Attach the standard air filter</b> (Necessary installation)</p>  <p><b>ATTENTION:</b> The white side of the photocatalyst air purifying filter face outside, and the black side face the unit. The green side of the bacteria-killing medium air purifying filter face outside, and the white side face the unit.</p> <p><b>5. Close the Inlet Grille</b> Close the Grille surely</p>
<p><b>3. Attach Air Purifying Filter</b> Put air purifying filter appliances into the right and left filter frames.</p> 	<p><b>NOTE:</b></p> <ul style="list-style-type: none"> <li>The photocatalyst air purifying filter will be solarized in fixed time. In normal family, it will be solarized every 6 months.</li> <li>The bacteria-killing medium air purifying filter will be used for a long time, no need for replacement. But in the period of using them, you should remove the dust frequently by using vacuum cleaner or flapping them lightly, otherwise, its performance will be affected.</li> <li>Please keep the bacteria-killing medium air purifying filter in the cool and dry conditions avoid long time directly sunshine when you stop using it, or its ability of sterilization will be reduced.</li> </ul>

# Cautions

## ⚠ WARNING

Please call Sales/Service Shop for the Installation.

Do not attempt to install the air conditioner by yourself because improper works may cause electric shock, fire, water leakage.

## ⚠ WARNING

When abnormality such as burnt-smell found, immediately stop the operation button and contact sales shop.

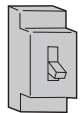

OFF



⚠  
STRICT  
ENFORCEMENT

Use an exclusive power source with a circuit breaker

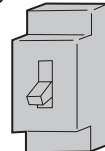

Check proper installation of the drainage securely



STRICT  
ENFORCEMENT

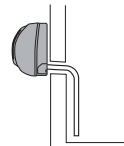

Connect power supply cord to the outlet completely



STRICT  
ENFORCEMENT

Use the proper voltage



STRICT  
ENFORCEMENT

1. Do not use power supply cord extended or connected in halfway  
2. Do not install in the place where there is any possibility of inflammable gas leakage around the unit.  
3. Do not get the unit exposed to vapor or oil steam.



PROHIBITION

Do not use power supply cord in a bundle.

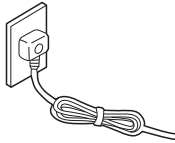

PROHIBITION

Take care not to damage the power supply cord.

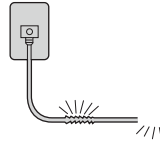

PROHIBITION

Do not insert objects into the air inlet or outlet.

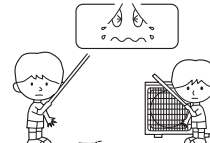

PROHIBITION

Do not start or stop the operation by disconnecting the power supply cord and so on.



PROHIBITION

Do not channel the air flow directly at people, especially at infants or the aged.



PROHIBITION

Do not try to repair or reconstruct by yourself.

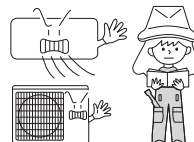

Connect the earth cable.

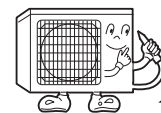

earthing

## ⚠ CAUTION

Do not use for the purpose of storage of food, art work, precise equipment, breeding, or cultivation.



PROHIBITION

Take fresh air occasionally especially when gas appliance is running at the same time.

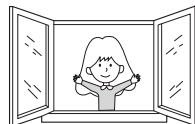

STRICT  
ENFORCEMENT

Do not operate the switch with wet hand.

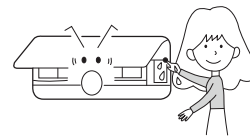

PROHIBITION

Do not install the unit near a fireplace or other heating apparatus.

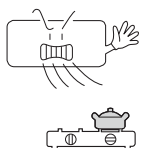

PROHIBITION

Check good condition of the installation stand

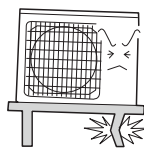

PROHIBITION

Do not pour water onto the unit for cleaning

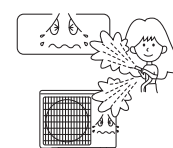

PROHIBITION

Do not place animals or plants in the direct path of the air flow

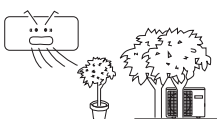

PROHIBITION

Do not place any objects on or climb on the unit.



PROHIBITION





Do not place flower vase or water containers on the top of the unit.



PROHIBITION

# Trouble shooting

Before asking for service, check the following first.

	Phenomenon	Cause or check points
Normal Performance inspection	The system does not restart immediately. 	<ul style="list-style-type: none"> <li>When unit is stopped, it won't restart immediately until 3 minutes have elapsed to protect the system.</li> <li>When the electric plug is pulled out and reinserted, the protection circuit will work for 3 minutes to protect the air conditioner.</li> </ul>
	Noise is heard 	<ul style="list-style-type: none"> <li>During unit operation or at stop, a swishing or gurgling noise may be heard. At first 2-3 minutes after unit start, this noise is more noticeable. (This noise is generated by refrigerant flowing in the system.)</li> <li>During unit operation, a cracking noise may be heard. This noise is generated by the casing expanding or shrinking because of temperature changes.</li> <li>Should there be a big noise from air flow in unit operation, air filter may be too dirty.</li> </ul>
	Smells are generated.	<ul style="list-style-type: none"> <li>This is because the system circulates smells from the interior air such as the smell of furniture, paint, cigarettes.</li> </ul>
	Mist or steam are blown out. 	<ul style="list-style-type: none"> <li>During COOL or DRY operation, indoor unit may blow out mist. This is due to the sudden cooling of indoor air.</li> </ul>
	In dry mode, fan speed can't be changed.	<ul style="list-style-type: none"> <li>In DRY mode, when room temperature becomes lower than temp. setting+3.6°F, unit will run intermittently at LOW speed regardless of FAN setting.</li> </ul>
Multiple check		<ul style="list-style-type: none"> <li>Is power plug inserted?</li> <li>Is there a power failure?</li> <li>Is fuse blownout?</li> </ul>
	Poor cooling 	<ul style="list-style-type: none"> <li>Is the air filter dirty? Normally it should be cleaned every 15 days.</li> <li>Are there any obstacles before inlet and outlet?</li> <li>Is temperature set correctly?</li> <li>Are there some doors or windows left open?</li> <li>Is there any direct sunlight through the window during the cooling operation?(Use curtain)</li> <li>Are there too much heat sources or too many people in the room during cooling operation?</li> </ul>

# Cautions

- Do not obstruct or cover the ventilation grille of the air conditioner. Do not put fingers or any other things into the inlet/outlet and swing louver.
- Do not allow children to play with the air conditioner. In no case should children be allowed to sit on the outdoor unit.

## Specifications

- The refrigerating circuit is leak-proof.

The machine is adaptive in following situation

1. Applicable ambient temperature range:

Cooling	Indoor	Maximum: D.B/W.B 32°C/23°C Minimum: D.B/W.B 21°C/15°C
	Outdoor	Maximum: D.B/W.B 43°C/26°C Minimum: D.B 18°C
Heating	Indoor	Maximum: D.B 27°C Minimum: D.B 0°C
	Outdoor	Maximum: D.B/W.B 24°C/18°C Minimum: D.B/W.B -7°C/-8°C
	Outdoor (INVERTER)	Maximum: D.B/W.B 24°C/18°C Minimum: D.B -15°C

- If the power supply cord is damaged, it must be replaced by the manufacturer or its service agent or a similar qualified person.
- If the fuse of indoor unit on PC board is broken, please change it with the type of T. 3.15A/ 250V. If the fuse of outdoor unit is broken, change it with the type of T.25A/250V
- The wiring method should be in line with the local wiring standard.
- After installation, the power plug should be easily reached.
- The waste battery should be disposed properly.
- The appliance is not intended for use by young children or infirm persons without supervision.
- Young children should be supervised to ensure that they do not play with the appliance.
- Please employ the proper power plug, which fit into the power supply cord.
- A breaker should be incorporated into fixed wiring. The breaker should be all-pole switch and the distance between its two contacts should be not less than 3mm.
- The power plug and connecting cable must have acquired the local attestation.
- In order to protect the units, please turn off the A/C first, and at least 30 seconds later, cutting off the power.

## 7 Service Diagnosis

### 7.1 Caution for Diagnosis

The operation lamp flashes when any of the following errors is detected.

1. When a protection device of the indoor or outdoor unit is activated or when the thermistor malfunctions, disabling equipment operation.
2. When a signal transmission error occurs between the indoor and outdoor units. In either case, conduct the diagnostic procedure described in the following pages.

### 7.2. Problem Symptoms and Measures

Symptom	Check Item	Details of Measure
None of the units operates	Check the power supply.	Check to make sure that the rated voltage is supplied.
	Check the indoor PCB	Check to make sure that the indoor PCB is broken
Operation sometimes stops.	Check the power supply.	A power failure of 2 to 10 cycles can stop air conditioner operation.
Equipment operates but does not cool, or does not heat (only for heat pump)	Check for faulty operation of the electronic expansion valve.	Set the units to cooling operation, and compare the temperatures of the liquid side connection pipes of the connection section among rooms to check the opening and closing operation of the electronic expansion valves of the individual units.
	Diagnosis by service port pressure and operating current.	Check for insufficient gas.
Large operating noise and vibrations	Check the installation condition.	Check to make sure that the required spaces for installation (specified in the Technical Guide, etc.) are provided.

### 7.3.Error Codes and Description indoor display

	Code indication		Description	Reference Page
	indoor	Outdoor (LED1 flash times)		
Indoorand Outdoor	E7	15	Communication fault between indoor and outdoor units	Page .78
Indoor Malfunction	E1		Room temperature sensor failure	Page .69
	E2		Heat-exchange sensor failure	Page .69
	E4		Indoor EEPROM error	Page .77
	E14		Indoor fan motor malfunction	Page .70
Outdoor Malfunction		1	Outdoor EEPROM error	Page .77
		2	The protection of IPM	Page .72
		3	Overcurrent protection of AC electricity for the outdoor model	
		4	Communication fault between the IPM and outdoor PCB	Page 73
		6	Power voltage is too high or low	Page .81
		8	Overheat protection for exhaust temperature	Page .75
		9	outdoor fan motor malfunction	
		10	Frost-removing temperature sensor failure	Page .74
		11	SUCK temperature sensor failure	Page .74
		12	Ambient temperature sensor failure	Page .74
		13	Exhaust temperature sensor failure	Page .74
		18	deviate from the normal for the compressor	Page .82
		19	Loop of the station detect error	Page .82
		24	Overcurrent of the compressor	Page .83
	25	Overcurrent protection for single-phase of the compressor	Page .83	

### 7.3.1 Thermistor or Related Abnormality (indoor unit)

<b>Indoor Display</b>	<b>E1:</b> Room temperature sensor failure <b>E2:</b> Heat-exchange sensor failure
<b>Method of Malfunction Detection</b>	the temperatures detected by the thermistors are used to determine thermistor errors
<b>Malfunction Decision Conditions</b>	when the thermistor input is more than 4.92V or less than 0.08V during compressor operation.
<b>Supposed Causes</b>	* <b>Note:</b> The values vary slightly in some models <ul style="list-style-type: none"> <li>■ Faulty connector connection</li> <li>■ Faulty thermistor</li> <li>■ Faulty PCB</li> </ul>
<b>Troubleshooting</b>	* <b>Caution</b> Be sure to turn off power switch before connect or disconnect connector, or else parts damage may be occurred.

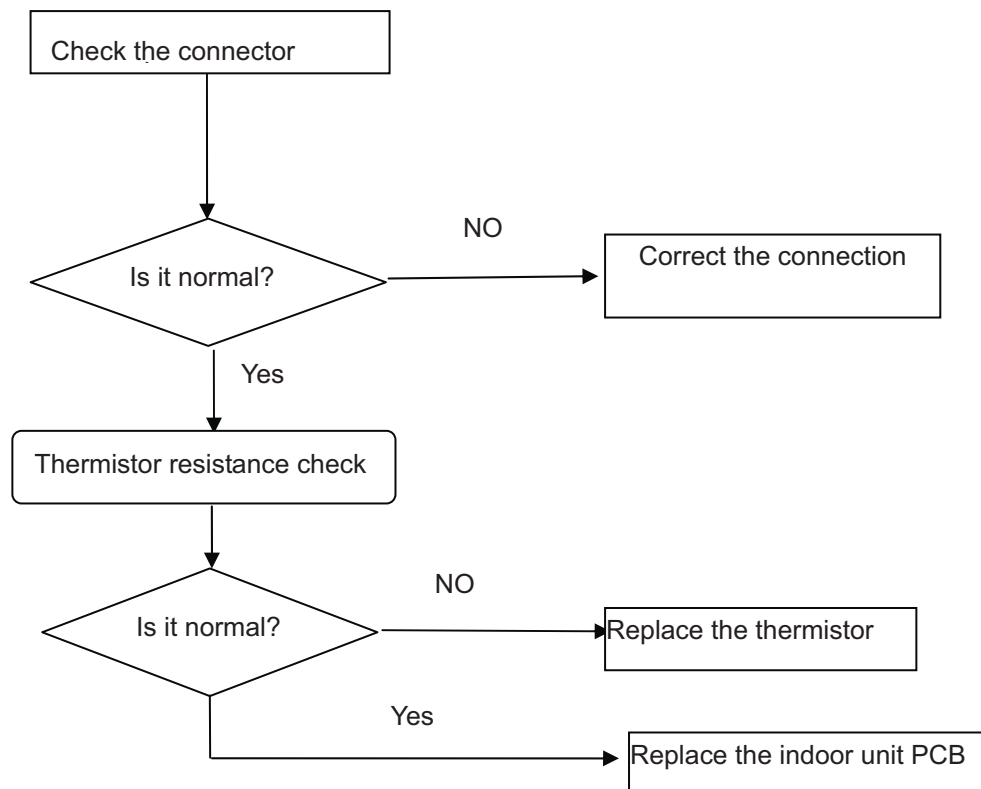

#### Thermistor resistance check method:

Remove the connector of the thermistor on the PCB, and measure the resistance of thermistor using tester. The relationship between normal temperature and resistance is shown in the value of indoor thermistor.

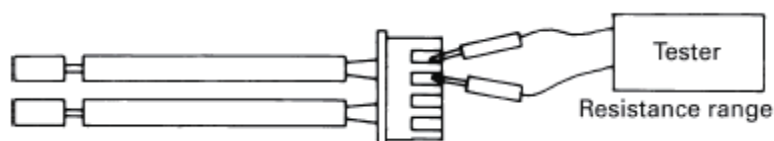

## 7.3.2 Indoor fan motor malfunction

Indoor display	<b>E14</b>
Method of Malfunction Detection	The rotation speed detected by the Hall IC during fan motor operation is used to determine abnormal fan motor operation
Malfunction Decision Conditions	when the detected rotation feedback signal don't received in 2 minutes
Supports causes	<ul style="list-style-type: none"> <li>■ Operation halt due to breaking of wire inside the fan motor .</li> <li>■ Operation halt due to breaking of the fan motor lead wires</li> <li>■ Detection error due to faulty indoor unit PCB</li> </ul>

### How to check Fan Motor (DC)

1. Check connector connection.
2. Check motor power supply voltage output (pins 1-4).
3. Check motor control voltage (pins 4-5).
4. Check rotation command voltage output (pins 4-6).
5. Check rotation pulse input (pins 4-7).

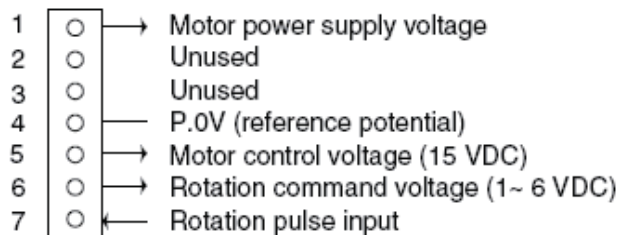

Notes:the a/c is electrifying,don't pull out or insert the terminals of the motor,else the motor would be damaged

**Troubleshooting** \* **Caution** Be sure to turn off power switch before connect or disconnect connector, or else parts damage may be occurred.

Turn off power supply and rotate fan by hand

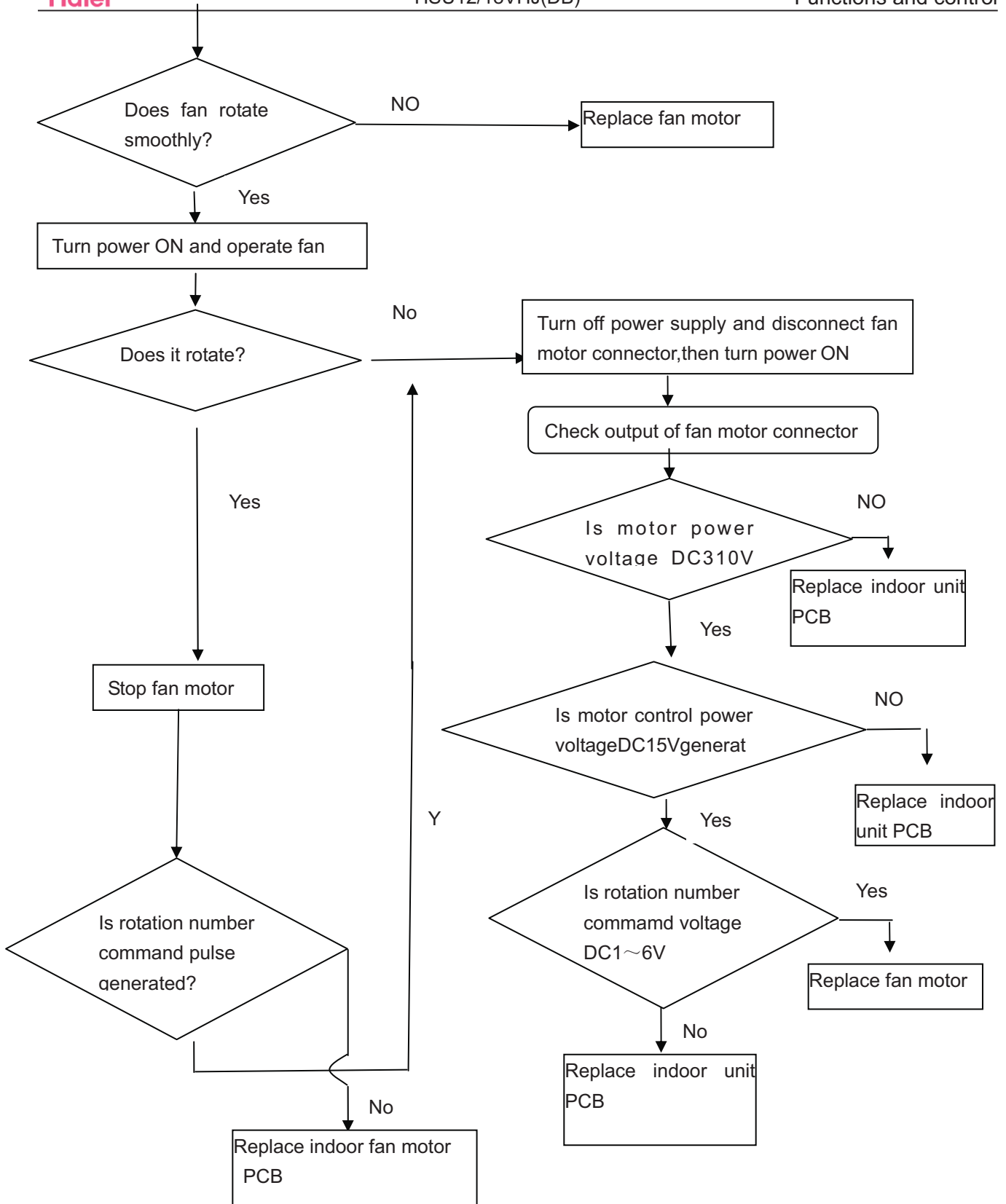



### 7.3.3 IPM protection

<b>outdoor display</b>	LED1 flash 2 times: <b>Indoor Display F1</b>
<b>Method of Malfunction Detection</b>	IPM protection is detected by checking the compressor running condition and so on.
<b>Malfunction Decision Conditions</b>	<ul style="list-style-type: none"> <li>■ The system leads to IPM protection due to over current</li> <li>■ The compressor faulty leads to IPM protection</li> <li>■ circuit component of IPM is broken and led to IPM protection</li> </ul>
<b>Supposed Causes</b>	<ul style="list-style-type: none"> <li>■ IPM protection dues to the compressor faulty</li> <li>■ IPM protection dues to faulty PCB of IPM module</li> <li>■ Compressor wiring disconnected</li> </ul>

**Troubleshooting** \* **Caution** Be sure to turn off power switch before connect or disconnect connector, or else parts damage may be occurred.

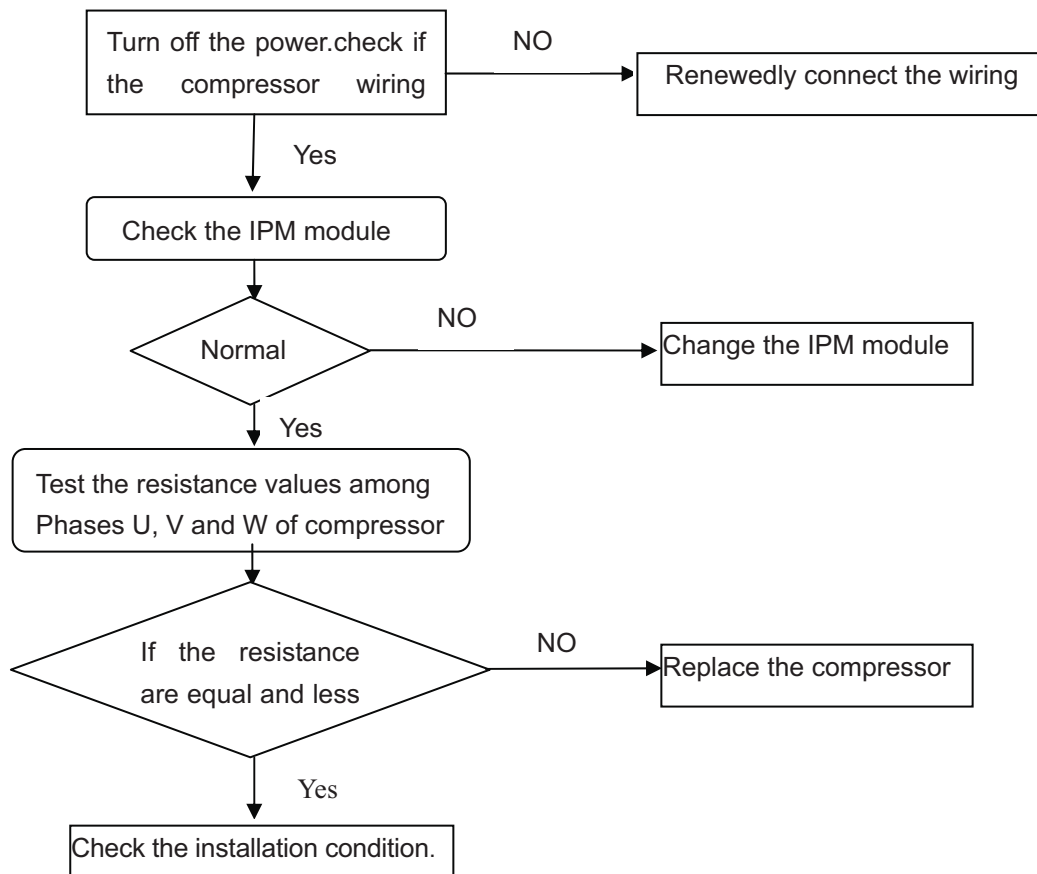

**Check the IPM module method:**

Disconnect the compressor harness connector from the outdoor unit PCB. To disengage the connector, press the protrusion on the connector. Then, to measure resistance between P (+) and N (-) and the U, V and W terminals of the compressor connector with a multi-tester. Evaluate the measurement results for a pass/fail judgment.

N(-)terminal of tester	P(+)	UVW	P(-)	UVW
P(+)	UVW	P(+)	UVW	P(-)

tester)				
Normal resistance	Several kΩ to several MΩ (*)			
Unacceptable resistance	Short (0 Ω) or open			

### 7.3.4 The IPM and outdoor PCB don't communicate or Related Abnormality

**outdoor display** LED1 flash 4 times Indoor Display F3

#### Method of Malfunction Detection

Communication is detected by checking the IPM module and the outdoor PCB

#### Malfunction Decision Conditions

- The outdoor PCB broken leads to communication fault
- The IPM module broken leads to communication fault

#### Supposed Causes

- The outdoor PCB is broken
- The IPM module is broken
- Communication wiring disconnected

**Troubleshooting** \* **Caution** Be sure to turn off power switch before connect or disconnect connector, or else parts damage may be occurred.

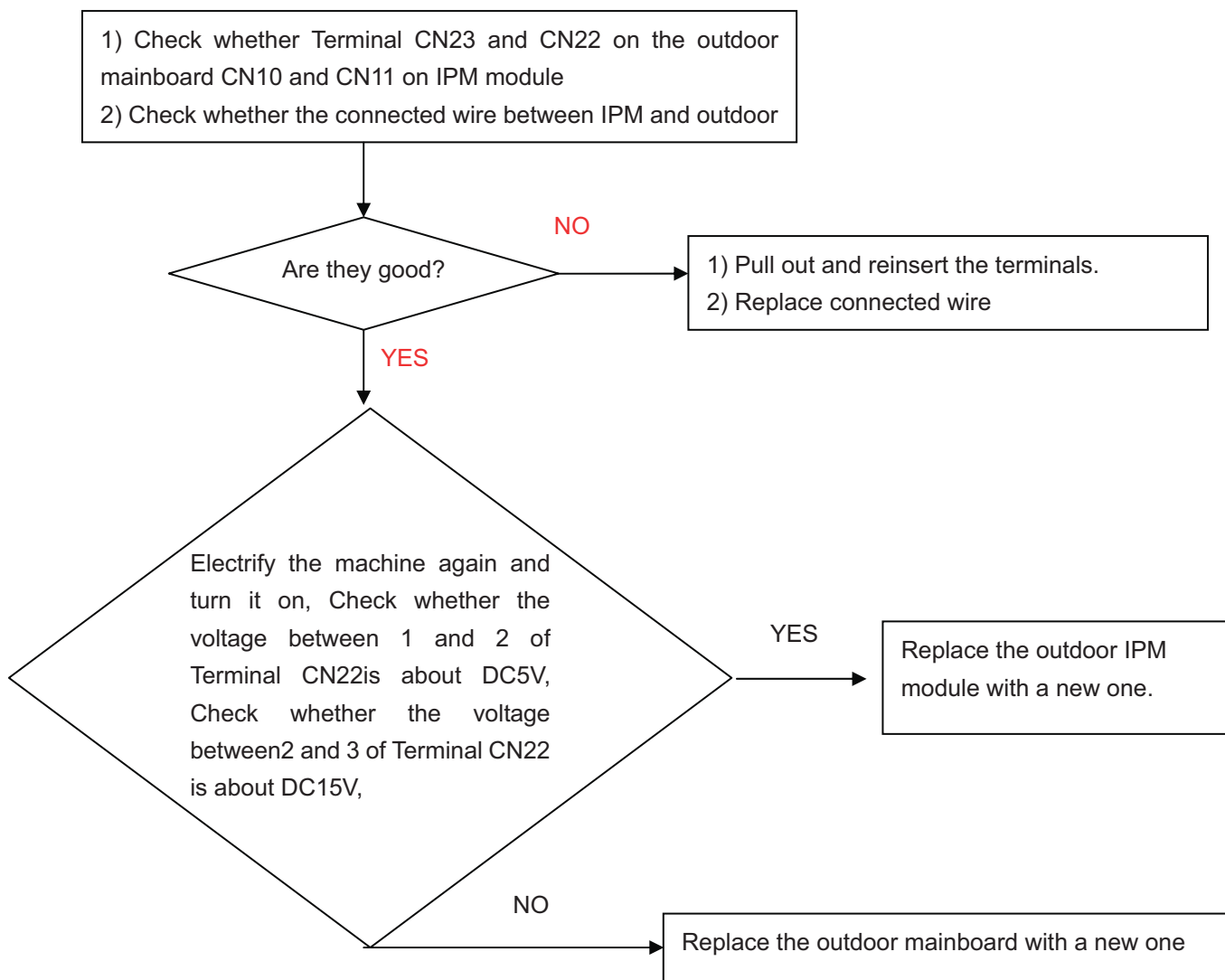

### 7.3.5 Thermistor or Related Abnormality(outdoor unit)

#### Frost-removing temperature sensor failure

Indoor display: F21  
 outdoor display: LED1 flash 10 times:

#### Exhaust temperature sensor failure

Indoor display: F25  
 outdoor display: LED1 flash 13 times:

#### Ambient temperature sensor failure

Indoor display: F6  
 outdoor display: LED1 flash 12 times:

#### Suck temperature sensor failure

Indoor display: F7  
 outdoor display: LED1 flash 11times:

**Method of Malfunction Detection** This type of error is detected by checking the thermistor input voltage to the microcomputer. (A thermistor error is detected by checking the temperature)

**Malfunction Decision Conditions** The thermistor input is above 4.9V or below 0.1V with the power on.  
 \* **Note:** The values may vary slightly in some models

**Supposed Causes**

- Faulty connector connection
- Faulty thermistor
- Faulty PCB

**Troubleshooting** \* **Caution** Be sure to turn off power switch before connect or disconnect connector, or else parts damage may be occurred.

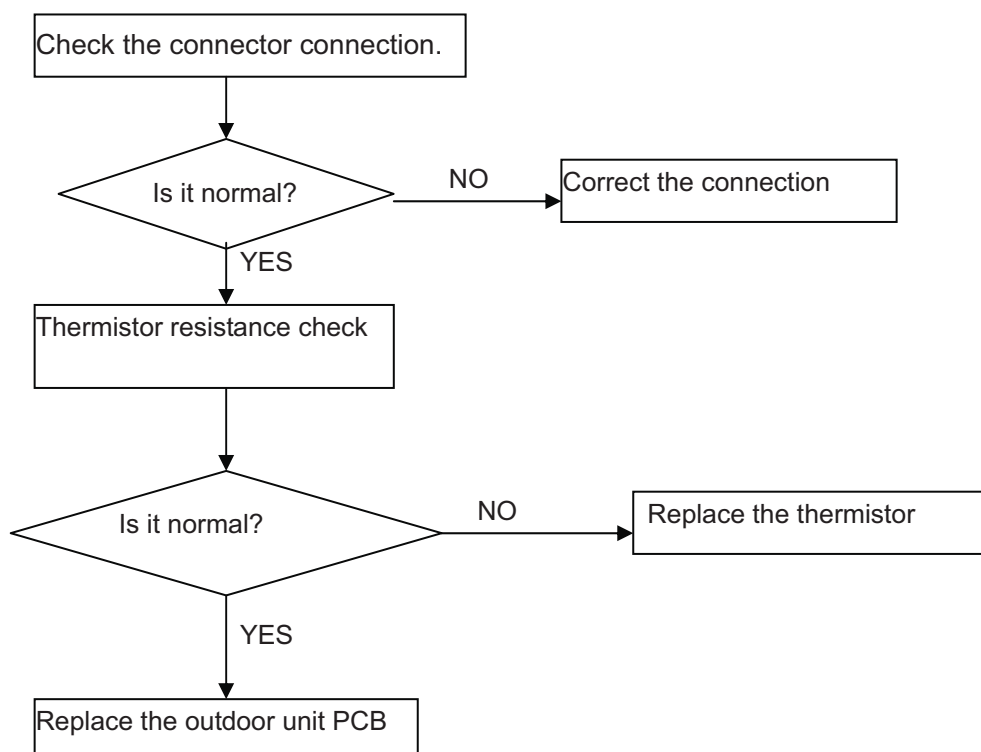

### 7.3.6 Overheat Protection For Exhaust Temperature

<b>Indoor display</b> <b>outdoor display</b>	<b>F4</b> LED1 flash 8 times
<b>Method of Malfunction Detection</b>	the exhaust temperature control is checked with the temperature being detected by the exhaust pipe thermistor
<b>Malfunction Decision Conditions</b>	when the compressor discharge temperature is above 117°C
<b>Supposed Causes</b>	<ul style="list-style-type: none"> <li>■ Electronic expansion valve defective</li> <li>■ Faulty thermistor</li> <li>■ Faulty PCB</li> </ul>

**Troubleshooting** \* Caution Be sure to turn off power switch before connect or disconnect connector, or else parts damage may be occurred.

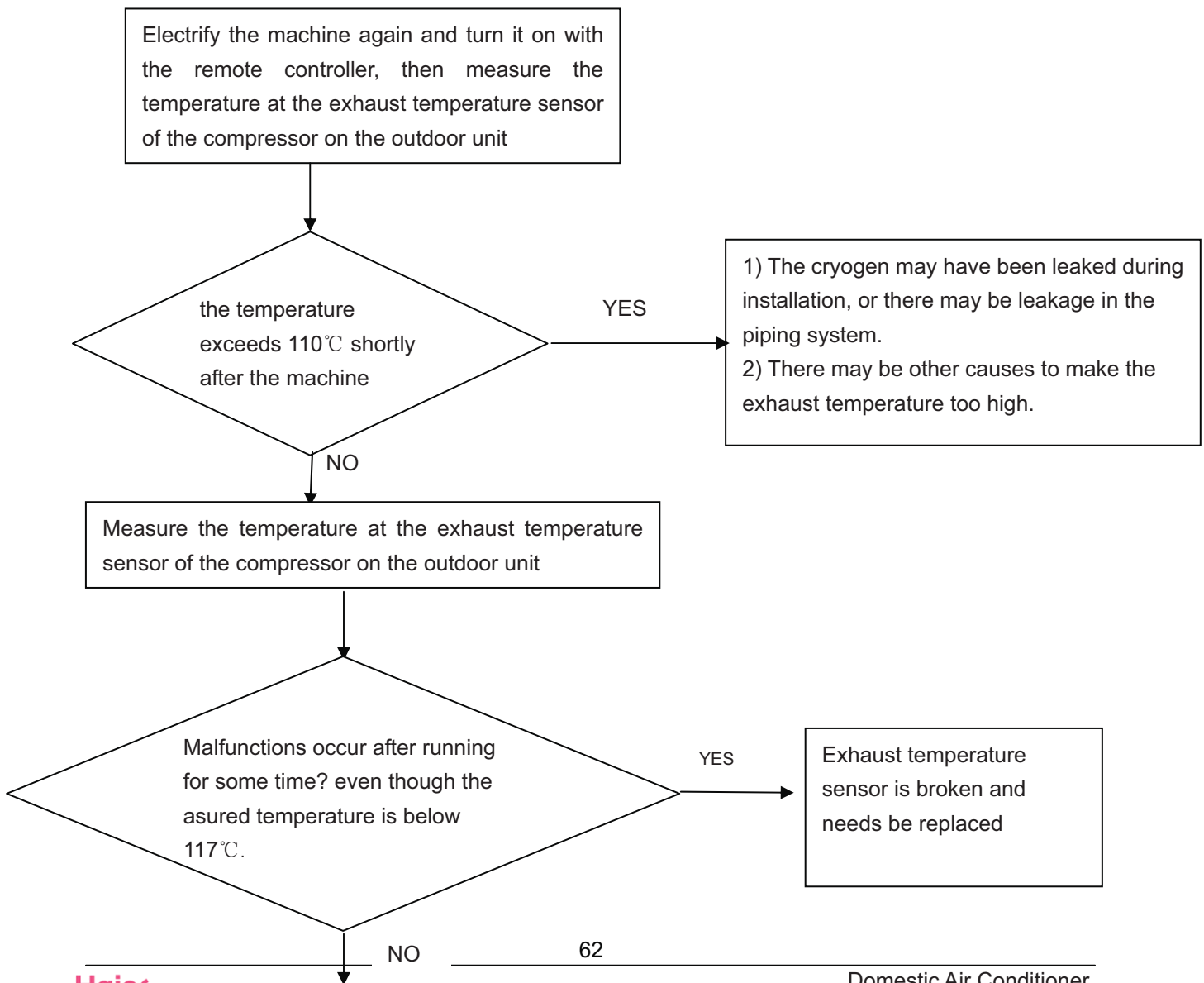

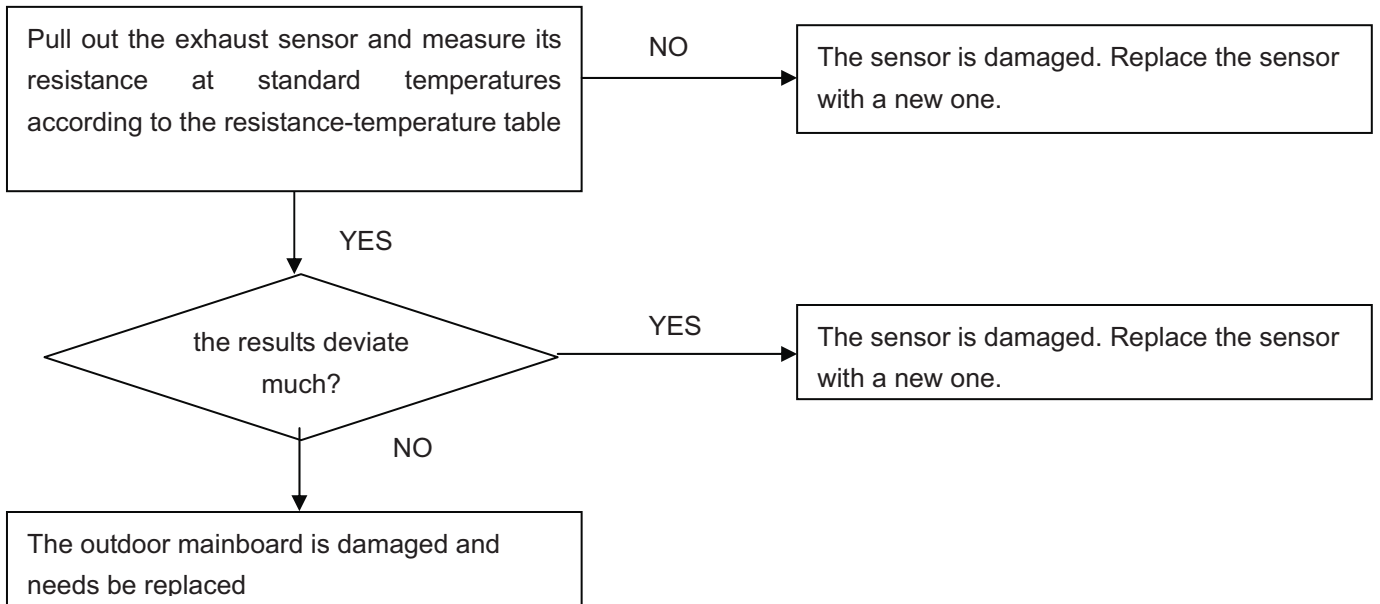

### 7.3.7 The EEPROM Abnormality (Indoor or outdoor unit)

<b>Indoor Display</b>	<b>E4:</b> : Indoor EEPROM error <b>F12:</b> Outdoor EEPROM error
<b>Method of Malfunction Detection</b>	the Data detected by the EEPROM are used to determine MCU
<b>Malfunction Decision Conditions</b>	when the Data of EEPROM is error or the EEPROM is damaged
<b>Supposed Causes</b>	<ul style="list-style-type: none"> <li>■ Faulty EEPROM data</li> <li>■ Faulty EEPROM</li> <li>■ Faulty PCB</li> </ul>

**Troubleshooting** \* **Caution** Be sure to turn off power switch before connect or disconnect connector, or parts damage may be occurred.

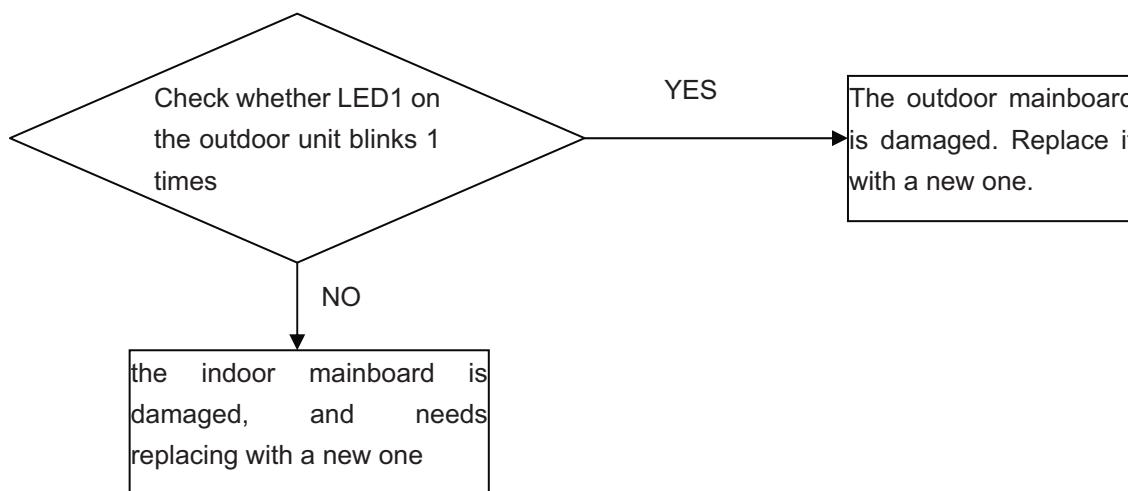



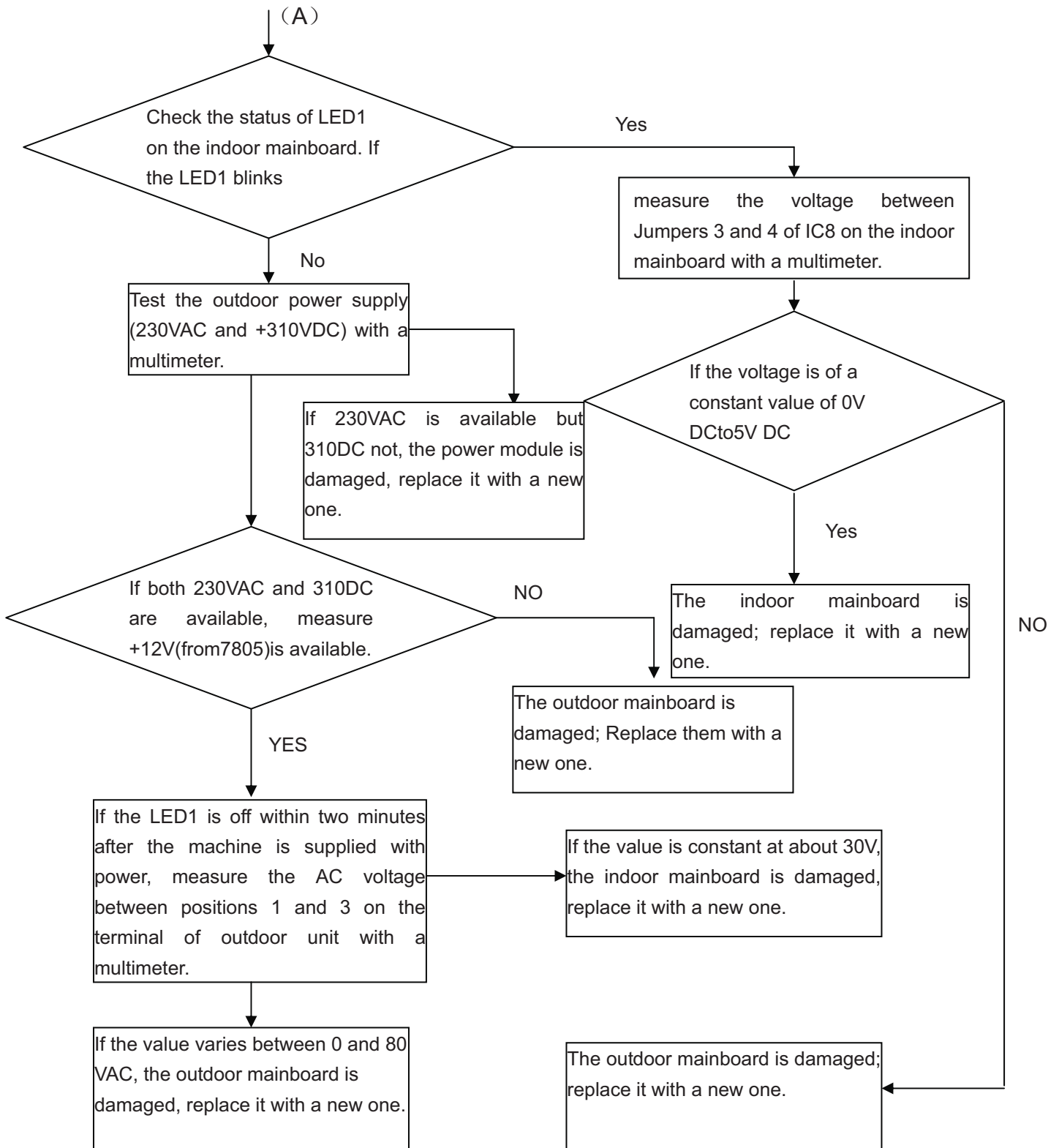

### 7.3.9 Power Supply Over or under voltage fault

<b>Indoor display</b> <b>outdoor display:</b>	<b>F19</b> LED1 flash 6 times
<b>Method of circuit.</b> <b>Malfunction Detection</b>	An abnormal voltage rise or fall is detected by checking the specified voltage detection
<b>Malfunction Decision Conditions</b> <b>Supposed Causes</b>	An voltage signal is fed from the voltage detection circuit to the microcomputer  <ul style="list-style-type: none"> <li>■ Supply voltage not as specified</li> <li>■ the IPM module is broken</li> <li>■ the outdoor PCB is broken</li> </ul>
<b>Troubleshooting</b>	* Caution Be sure to turn off power switch before connect or disconnect connector, or else parts damage may be occurred.

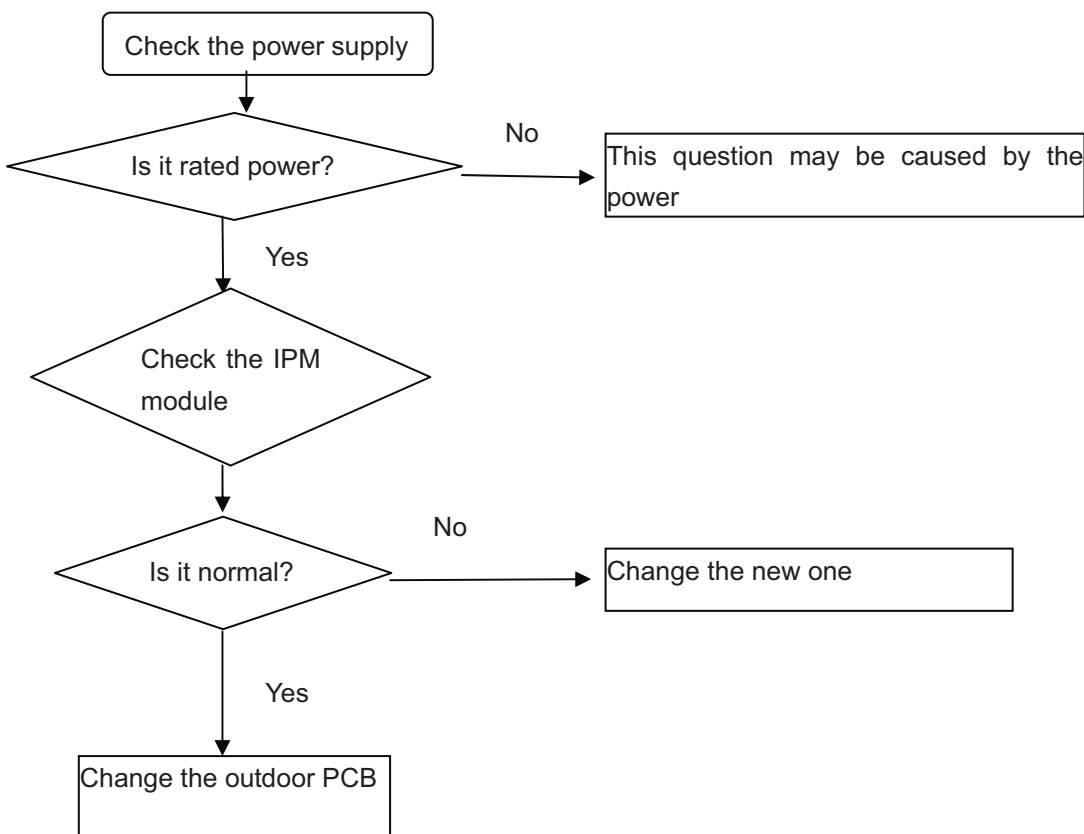

About how to check the IPM module, please refer to IPM protection fault



### 7.3.10 Loop of the station detect error

<b>Outdoor Display</b>	LED1 flash 18 times	Indoor Display	<b>F11</b>
	LED1 flash 19 times	Indoor Display	<b>F28</b>

**Method of Malfunction Detection** The position of the compressor rotor can not detected normally

**Malfunction Decision Conditions** when the The wiring of compressor is wrong or the connection is poor; or the compressor is damaged

- Supposed Causes**
- Faulty The wiring of compressor
  - Faulty compressor
  - Faulty PCB

**Troubleshooting** \* **Caution** Be sure to turn off power switch before connect or disconnect connector, or parts damage may be occurred.

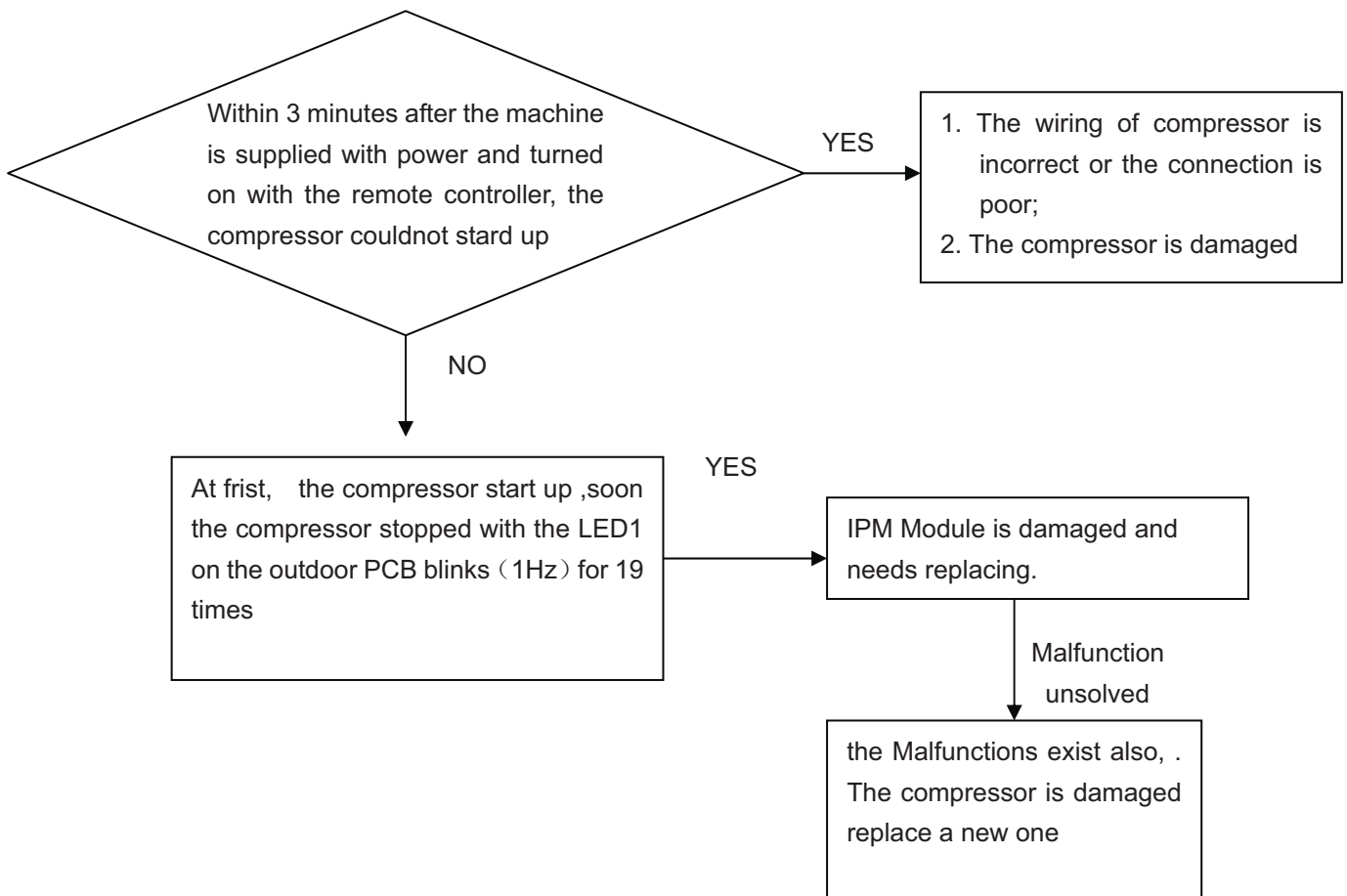

# 10. Appendix

## 10.1 Piping Diagrams

### Cooling mode

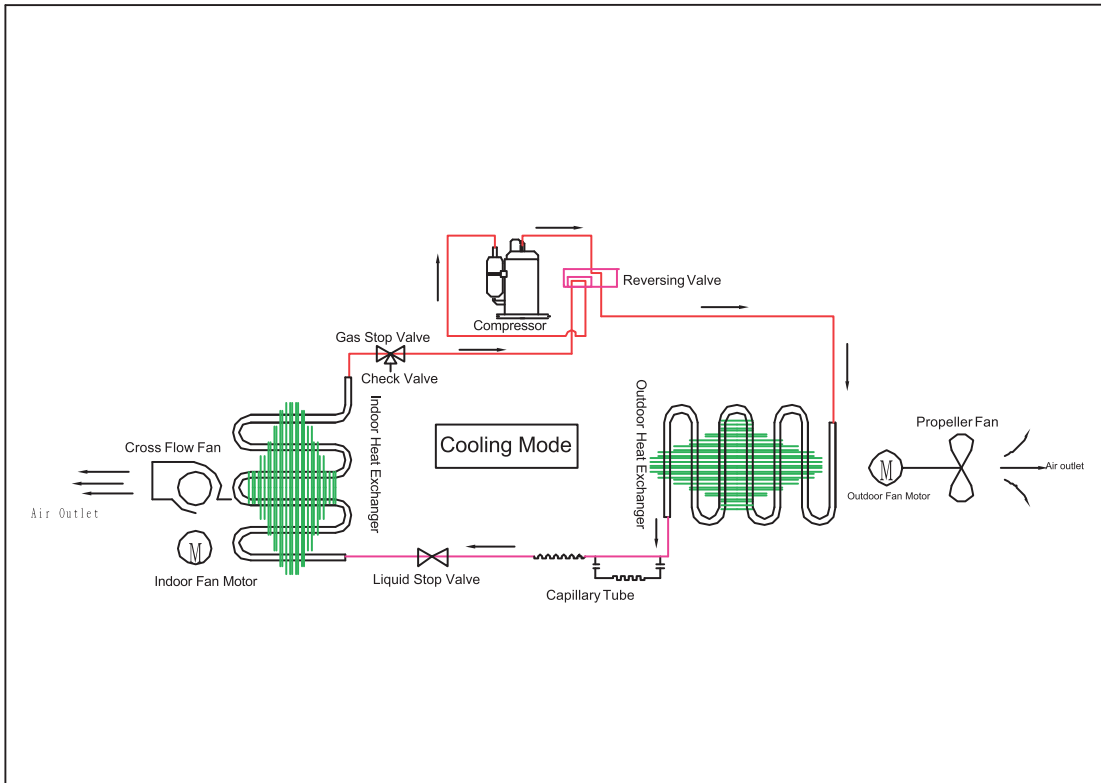

### Heating mode

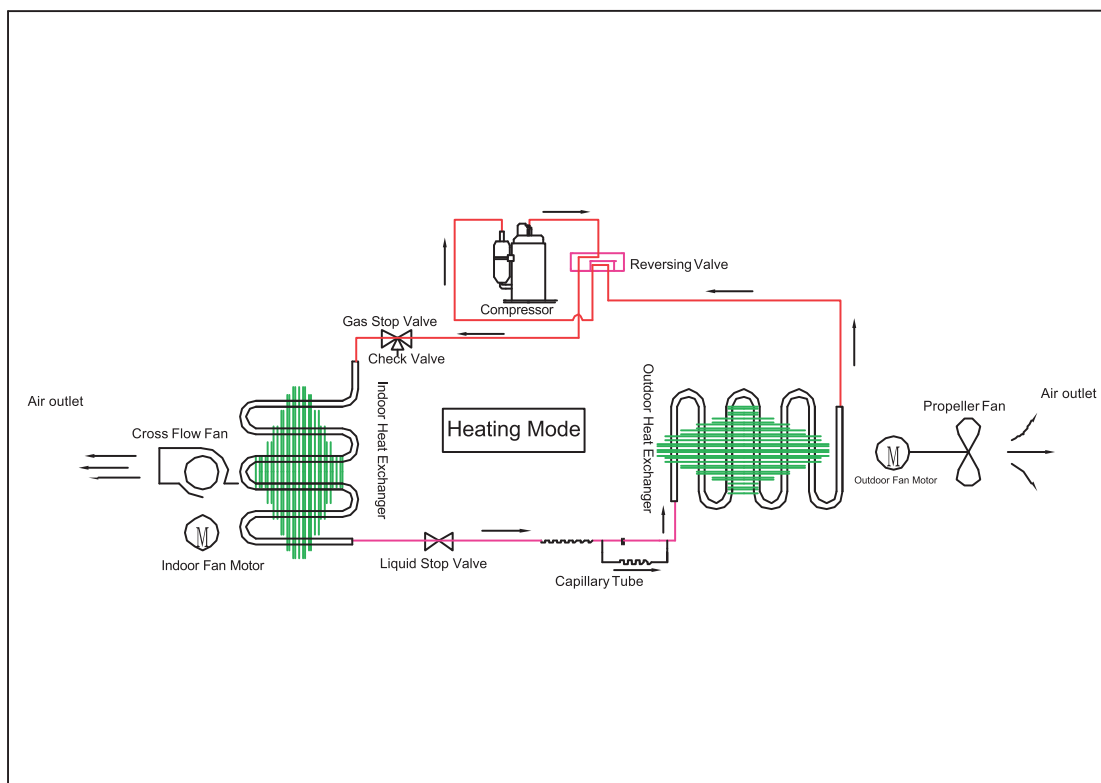

## 10.2 Wiring Diagrams

### 10.2.1. INDOORUNIT FOR12K

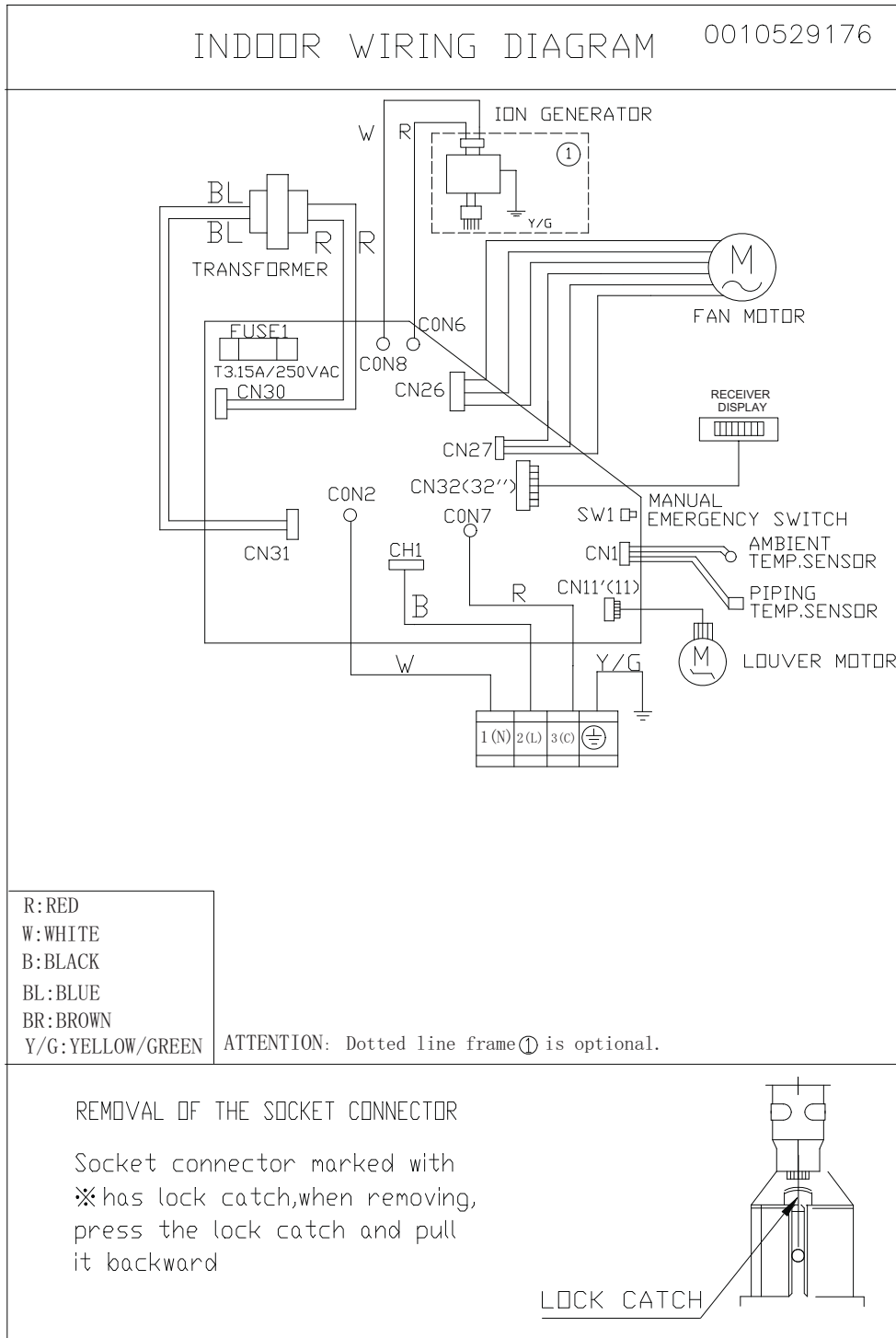

FOR18K

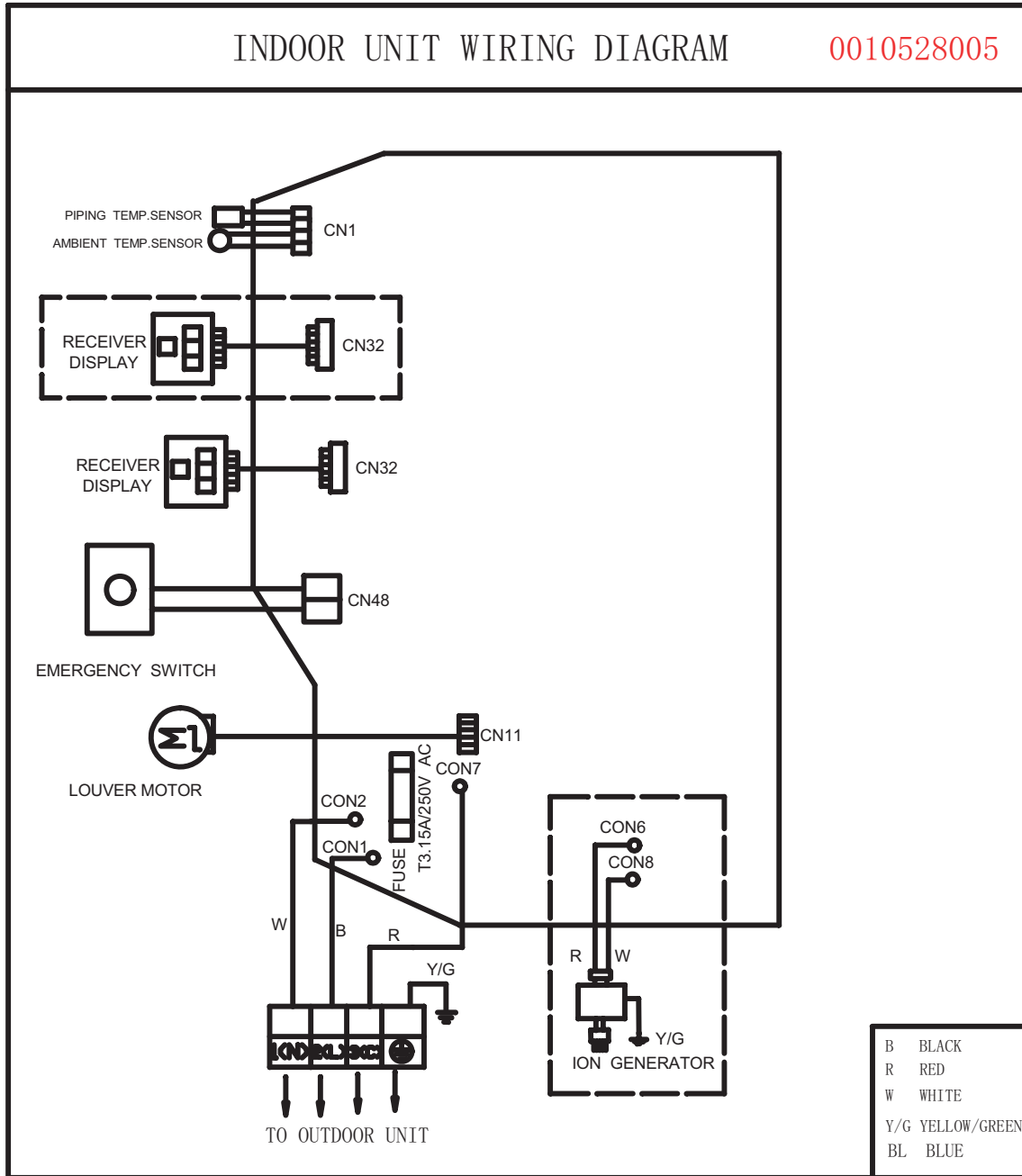

10.2.2. Outdoor unit

FOR12K

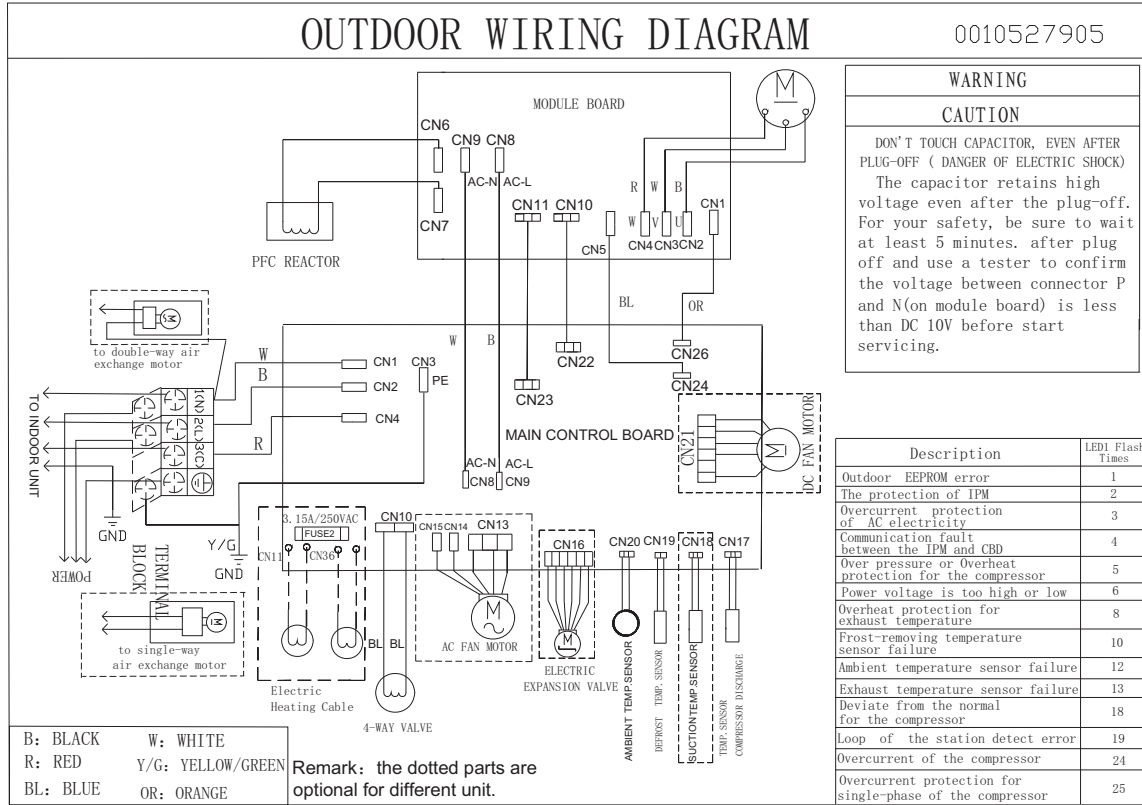

FOR18K

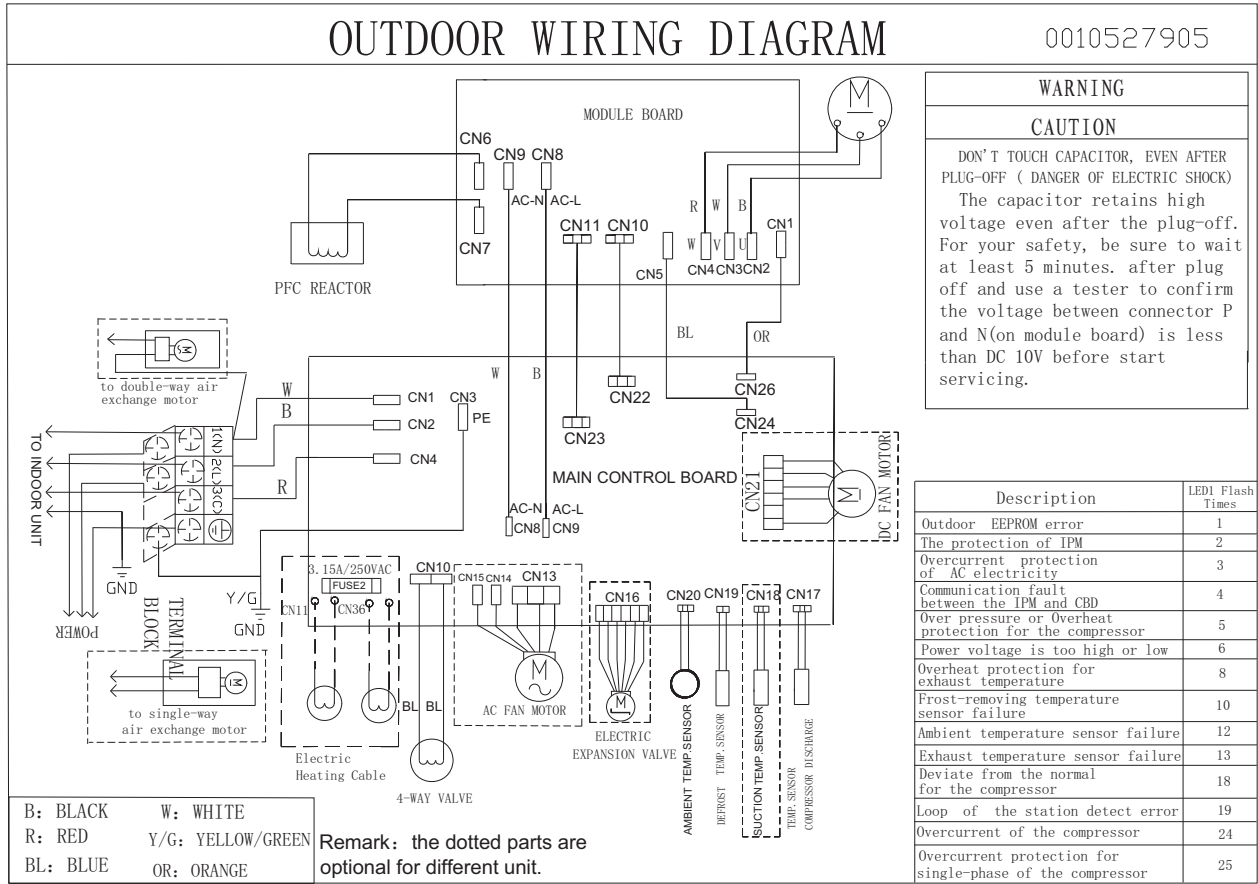

# 10.3. Circuit Diagrams

## 10.3.1. INDOORUNIT FOR12K

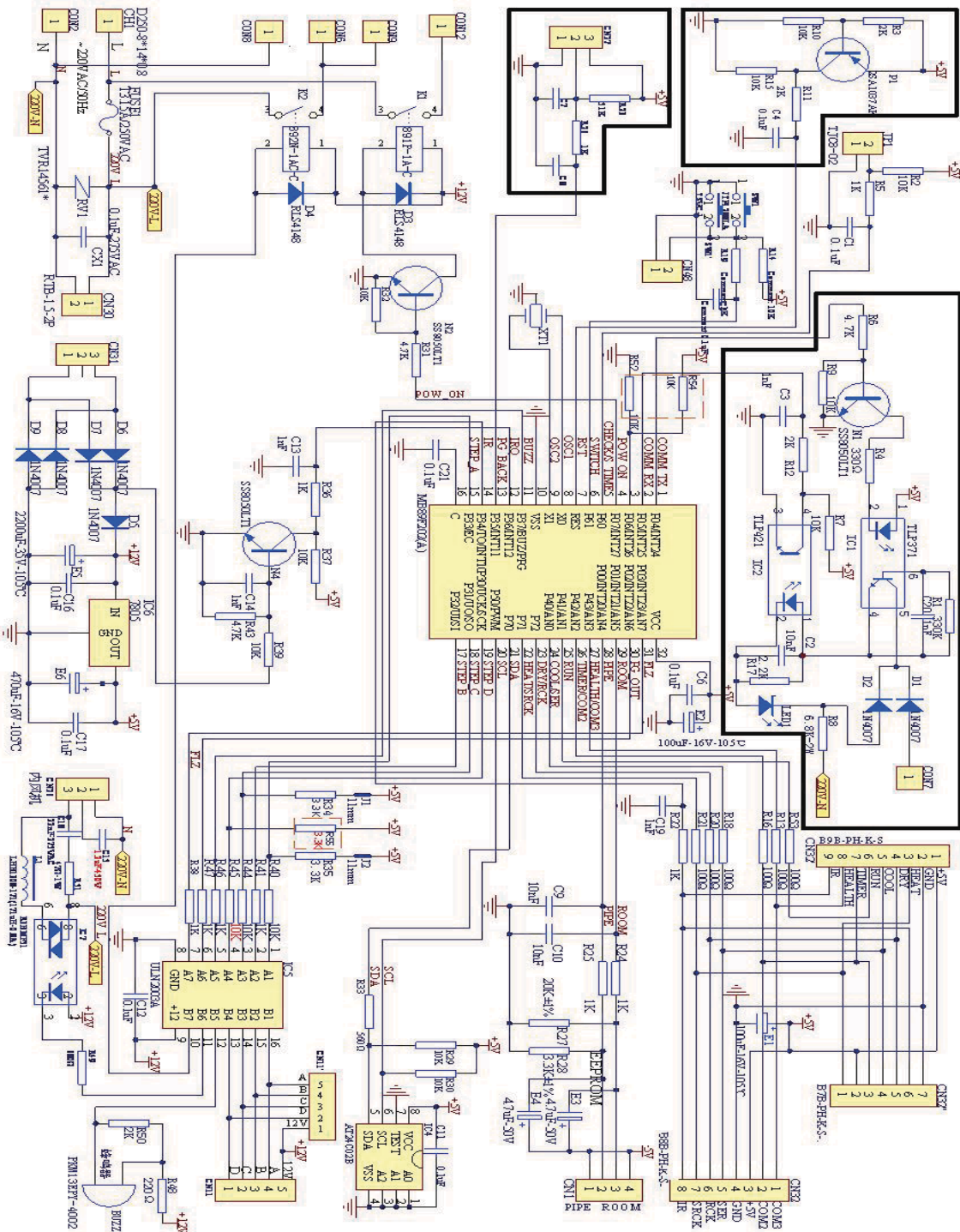

FOR18K

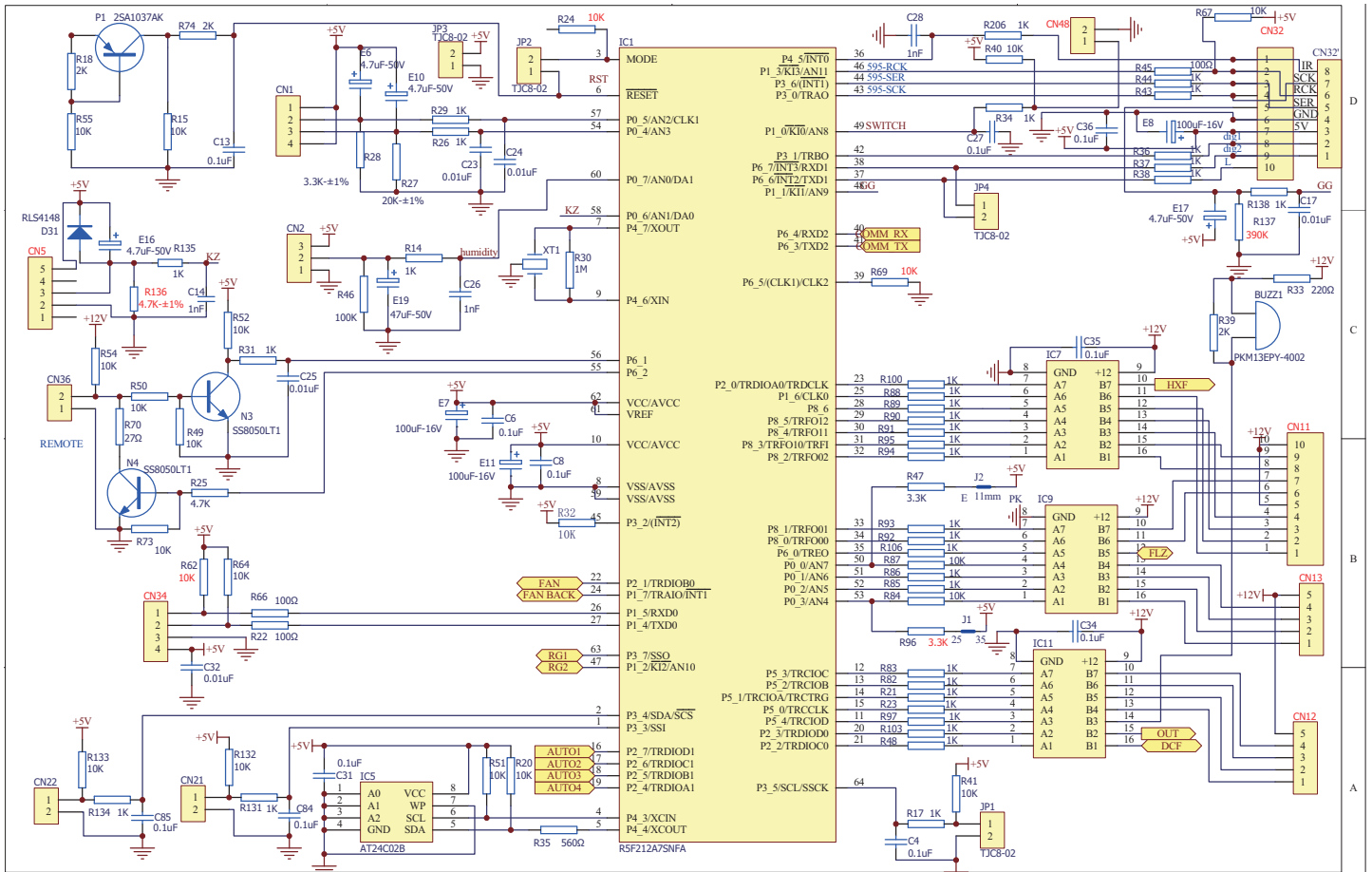



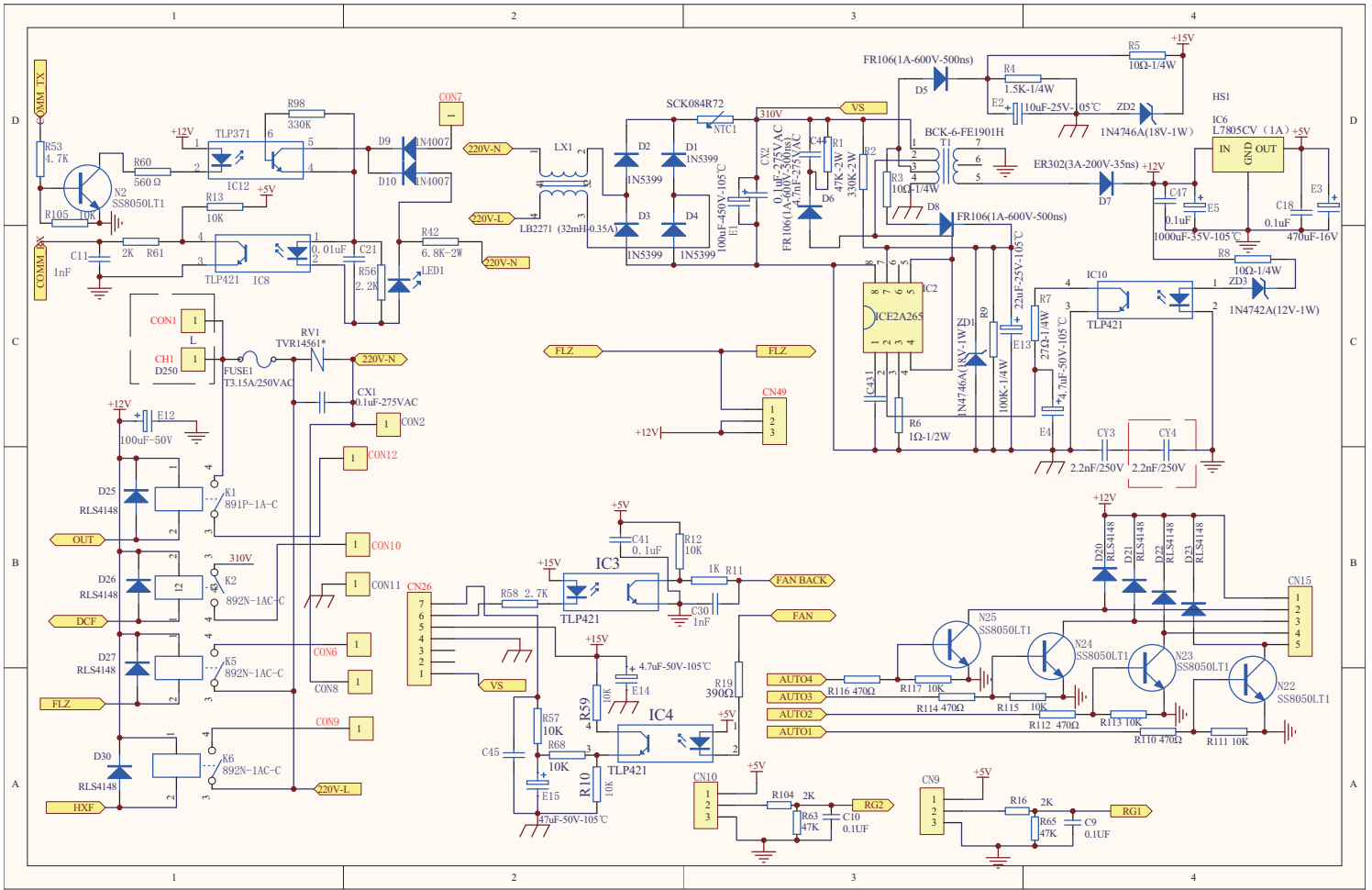

### 10.3.2.OUTDOORUNIT

### FOR12K

### module board Circuit Diagrams

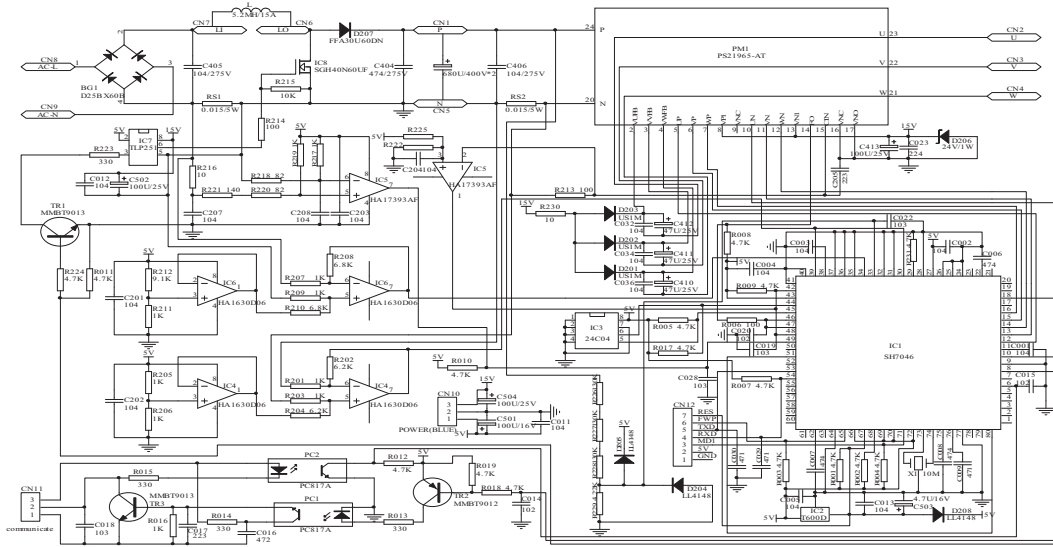

### control board Circuit Diagrams

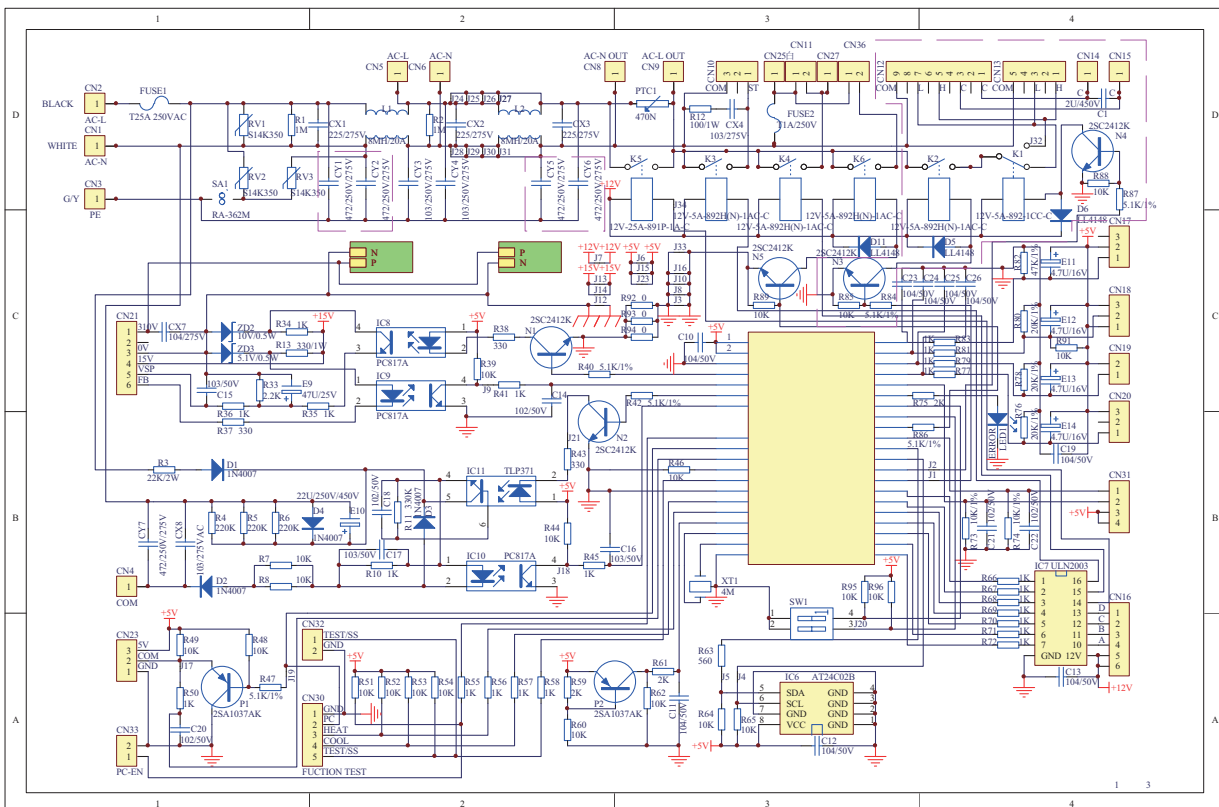

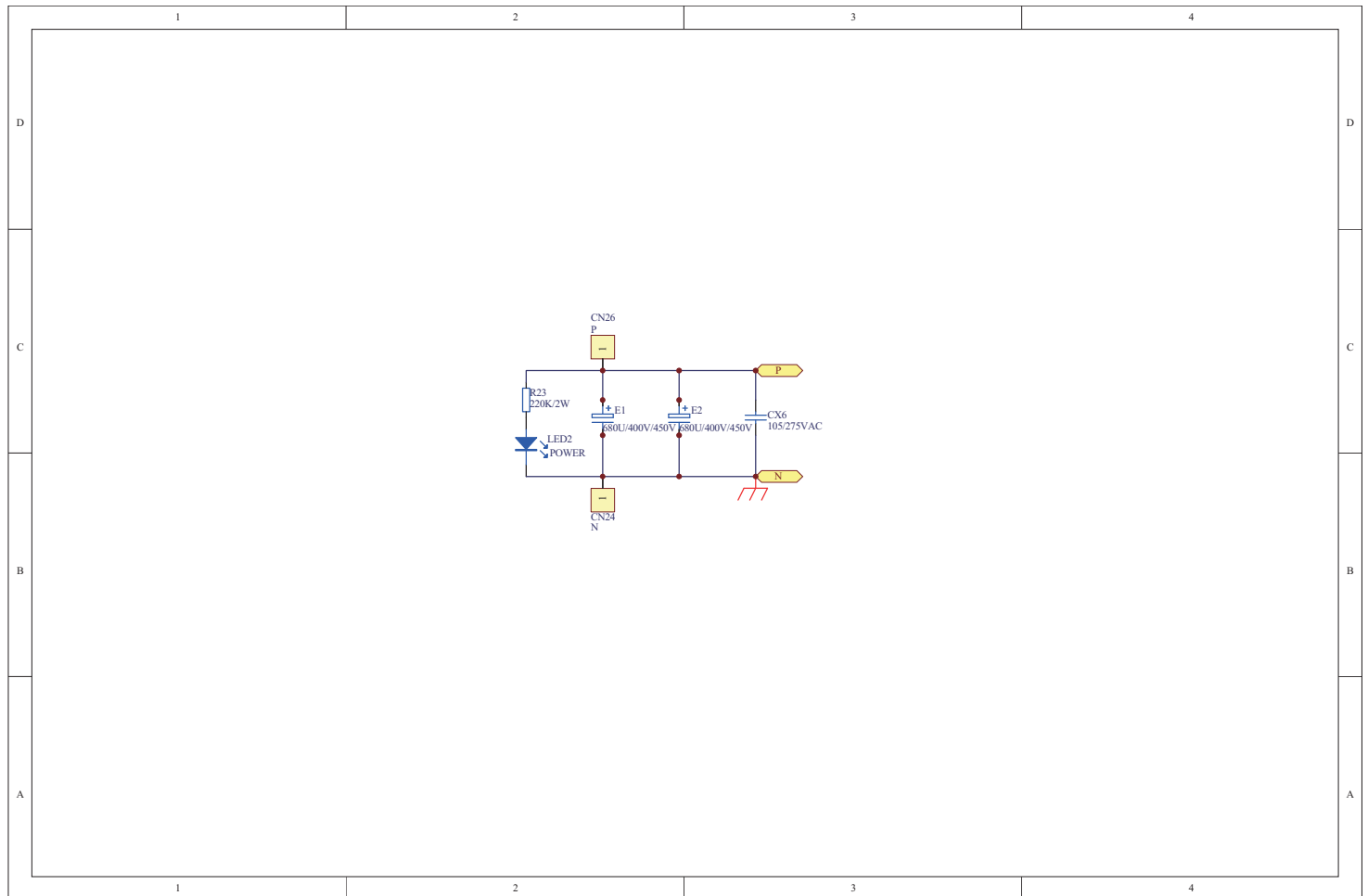
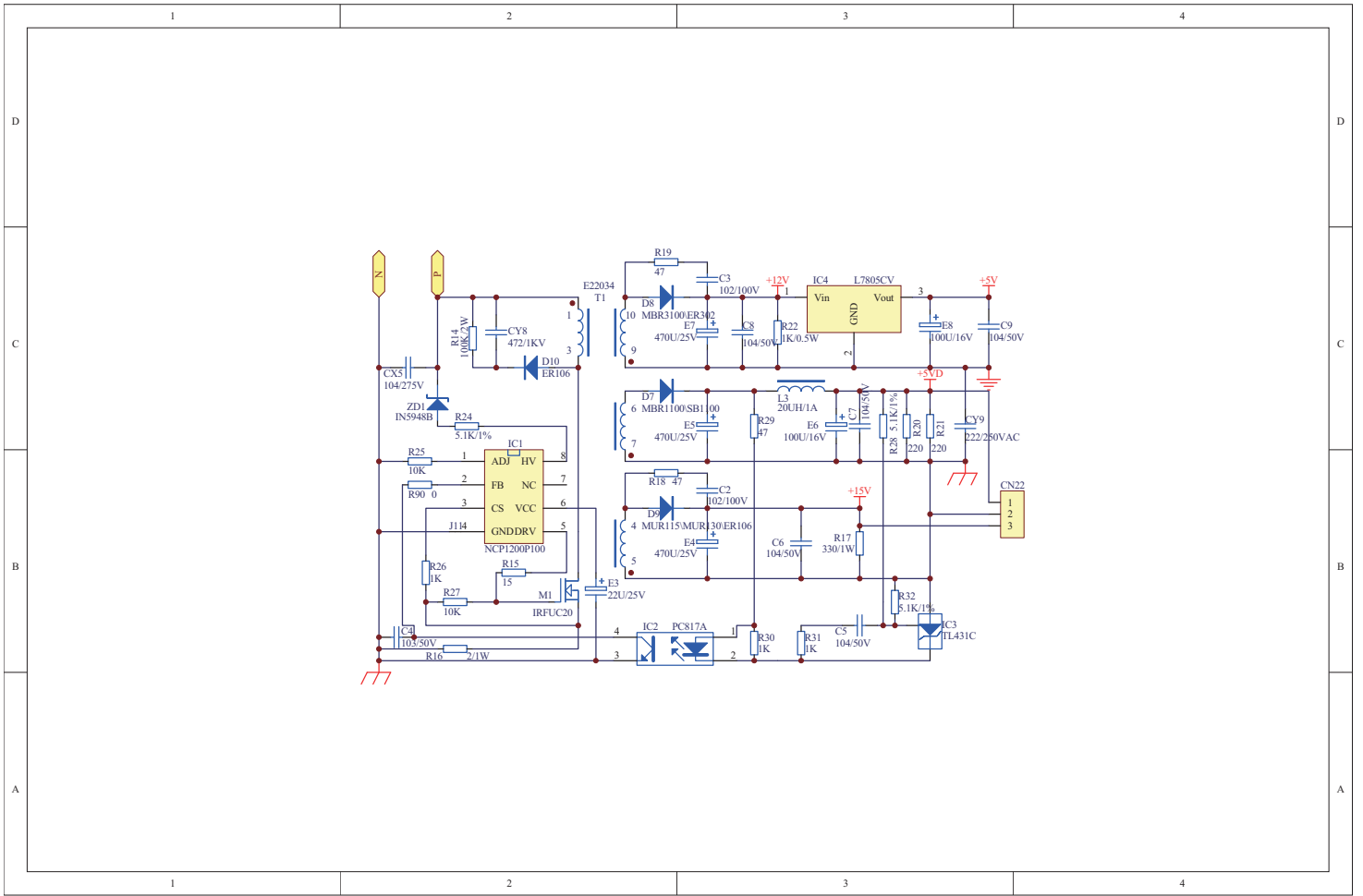

FOR18K

module board Circuit Diagrams

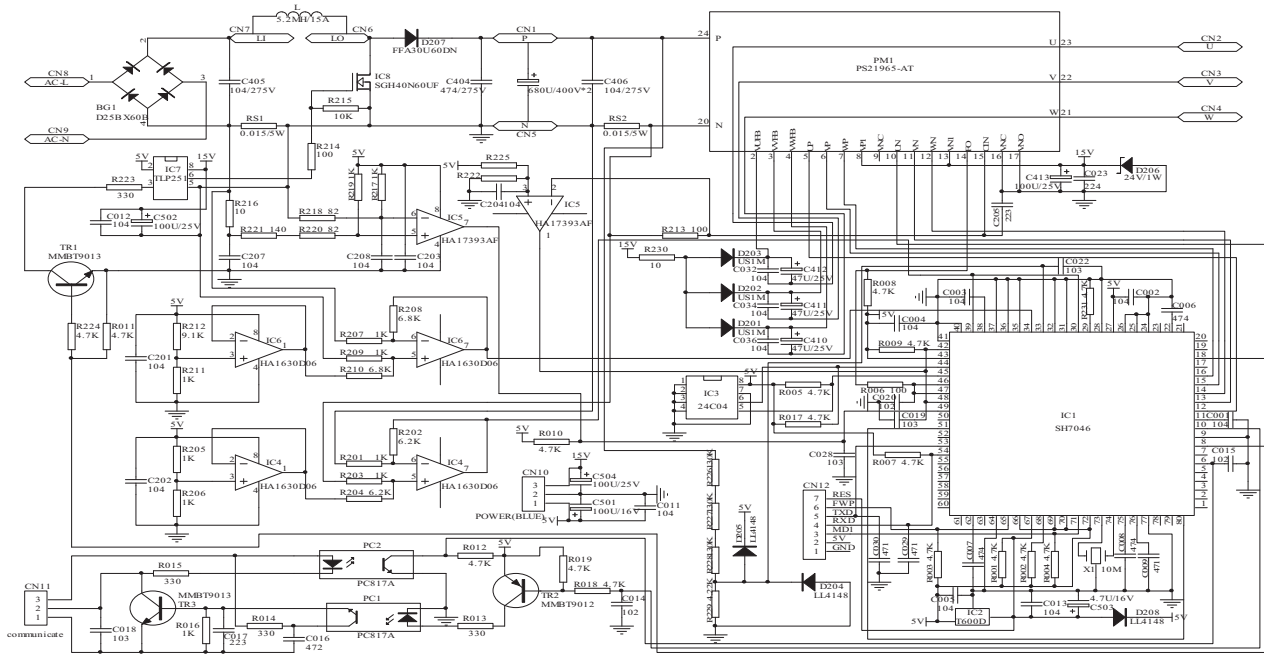

control board Circuit Diagrams

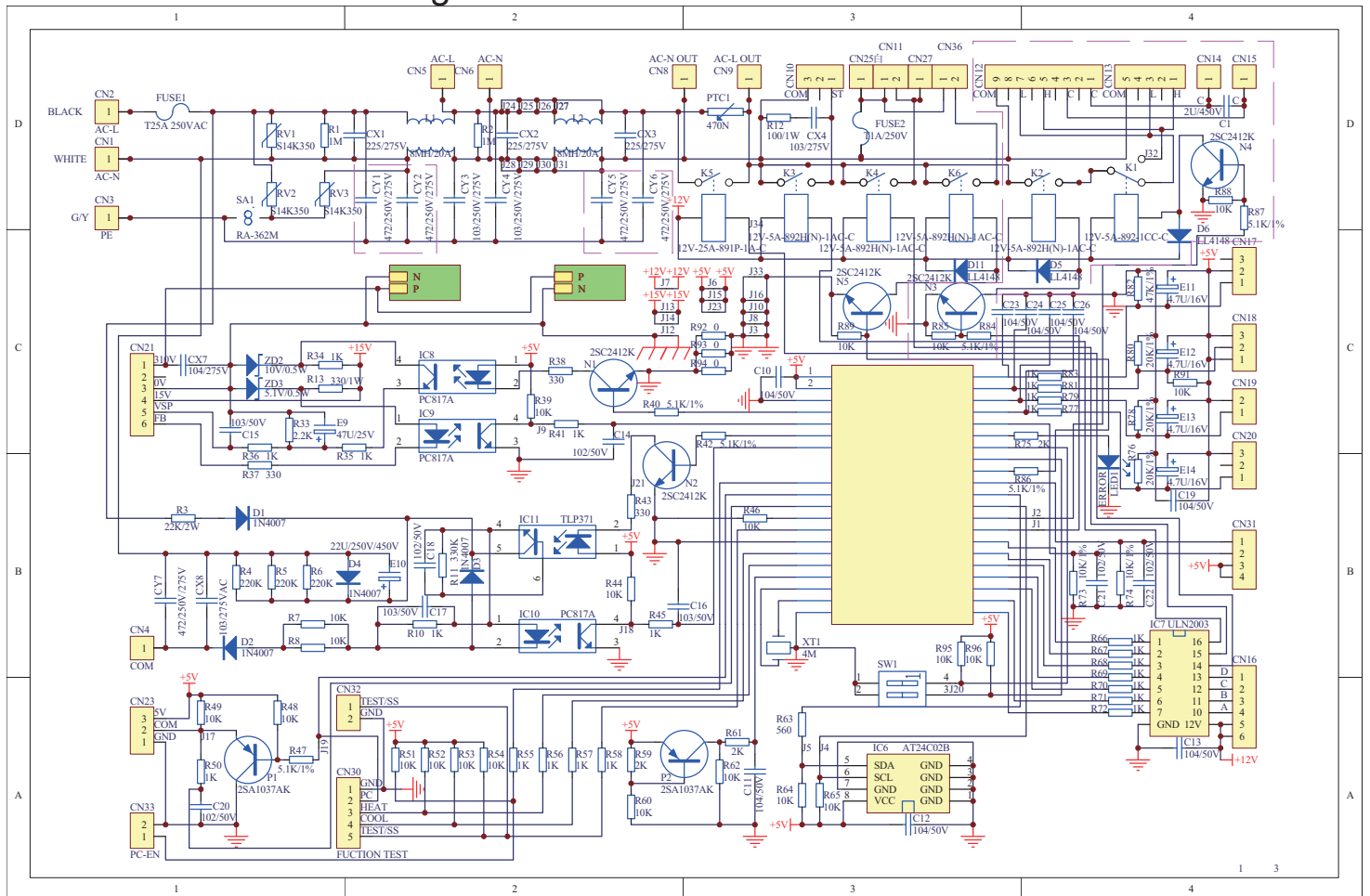

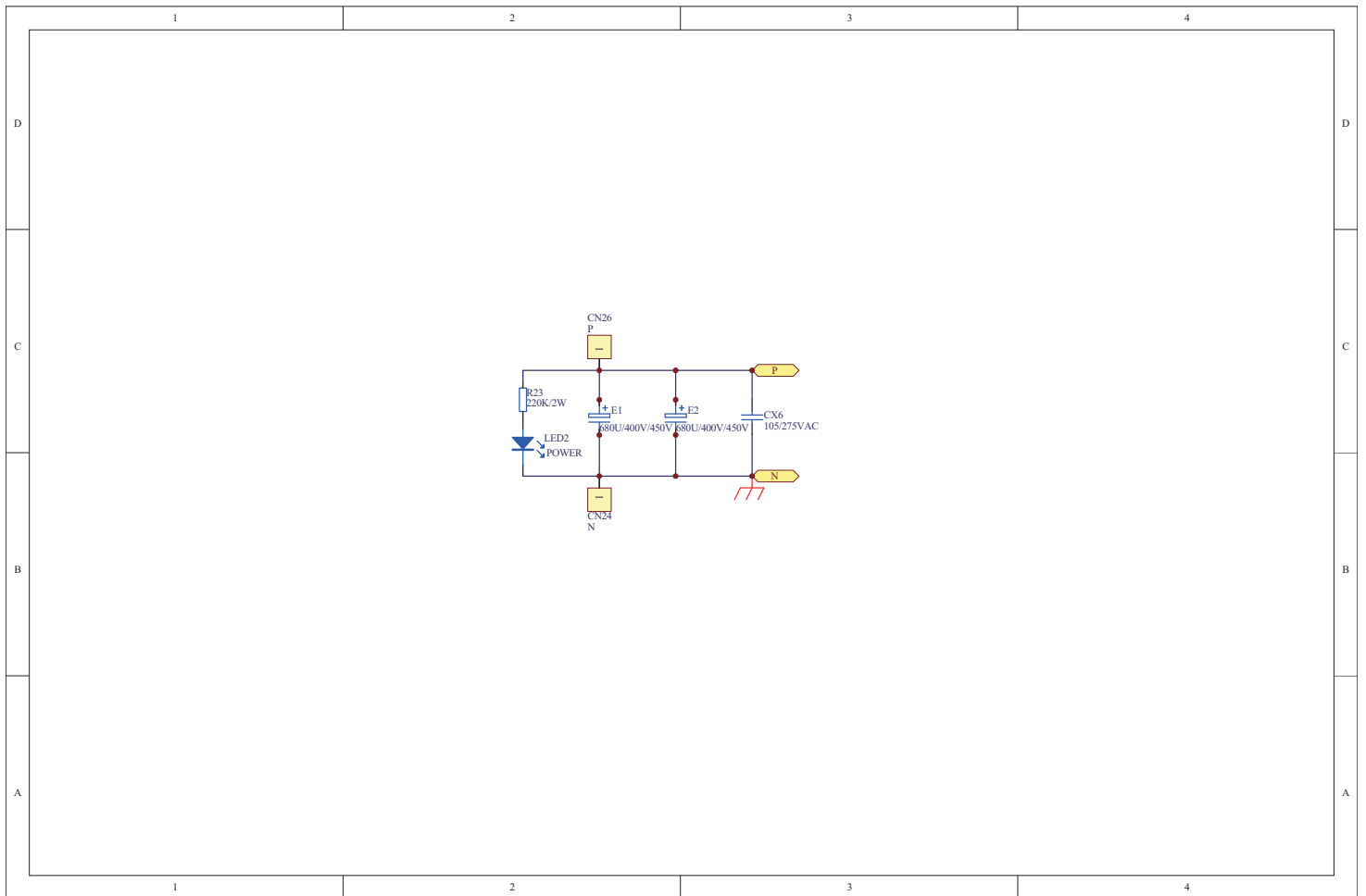
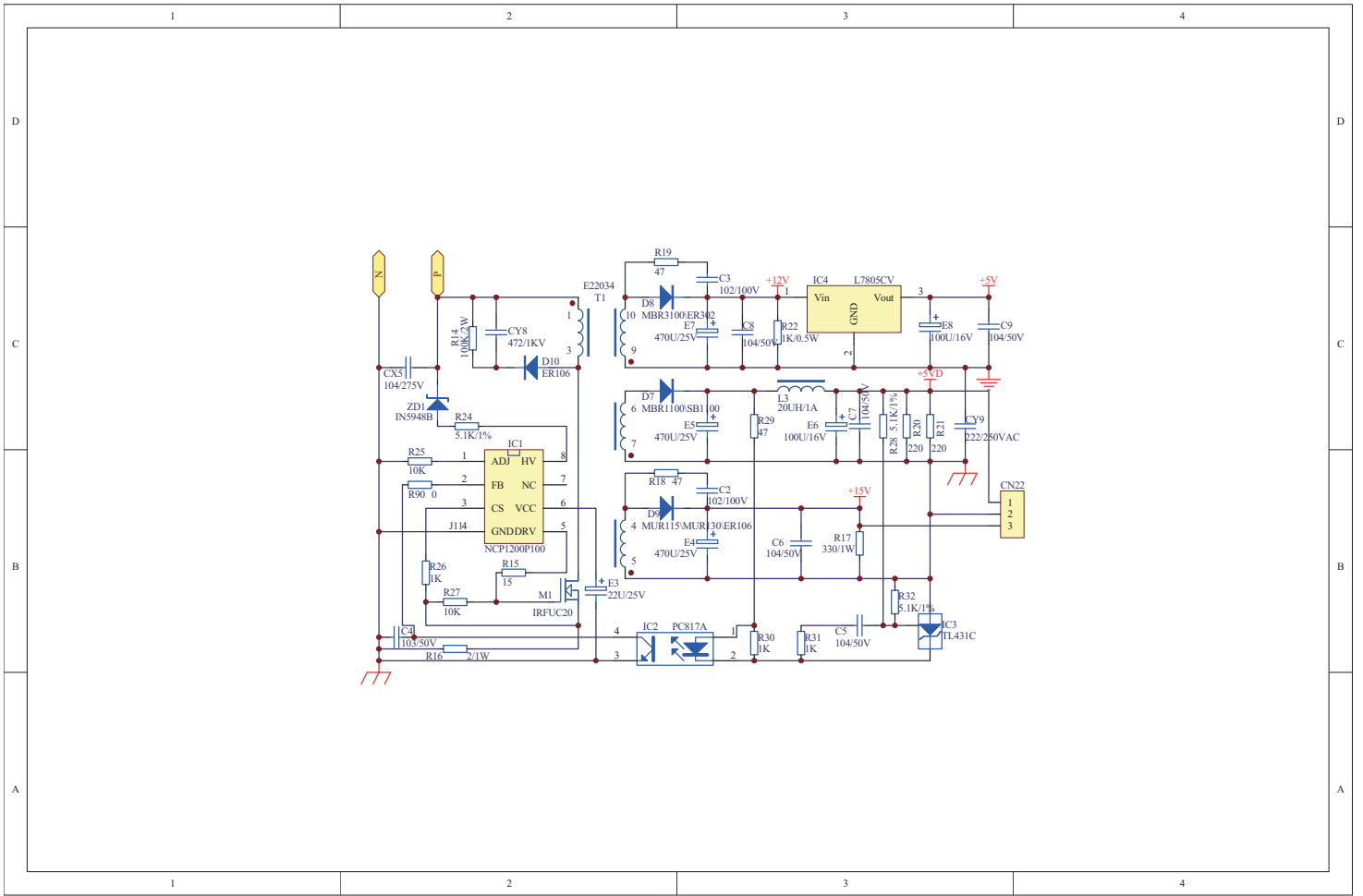

# Sincere Forever

## Haier Group

---

Haier Industrial Park, No.1, Haier Road  
266101, Qingdao, China\_

E-mail: [hractech@haier.com](mailto:hractech@haier.com)

Tel: +86 532 87636960

[Http://www.haier.com](http://www.haier.com)

Edited by: Liu Ming  
Sun Qiang

Signed by: Yang Bifei

Approved by:Wu Hongjin

# Haier

# SERVICE MANUAL

Order No.AC0910S008V0

## Wall mounted Type DC Inverter E-Series

### Model No. HSU12/18VHJ(DB)



12K



18K



12K



18K

### **WARNING**

This service information is designed for experienced repair technicians only and is not designed for use by the general public. It does not contain warnings or cautions to advise non-technical individuals of potential dangers in attempting to service a product. Products powered by electricity should be serviced or repaired only by experienced professional technicians. Any attempt to service or repair the product or products dealt with in this service information by anyone else could result in serious injury or death.

©2009 (Qingdao Haier Air Conditioner General corp.,Ltd)  
All right reserved .Unauthorized copying and distribution is a violation of law

## Haier Group

# Table of Contents

<b>1. Introduction</b> .....	1
<b>2. List of Functions</b> .....	6
<b>3. Specifications</b> .....	7
<b>4. Printed Circuit Board Connector Wiring Diagram</b> .....	9
<b>5. Functions and Control</b> .....	19
5.1 Main functions and control specifications of indoor unit .....	19
5.2 Main functions and control specifications of outdoor unit .....	25
5.3 Function of main thermistor .....	30
5.4 Value of thermistor .....	31
<b>6. System Configuration</b> .....	46
6.1 System Configuration.....	46
6.2 Instruction.....	46
<b>7. Service Diagnosis</b> .....	54
7.1 Caution for diagnosis.....	54
7.2 Problem Symptoms and Measures .....	54
7.3 Error codes and description indoor display .....	55
<b>8. Installations</b> .....	68
<b>9. Removal Procedure</b> .....	72
9.1 For 12K indoor unit .....	72
9.2 For 18K indoor unit.....	82
9.3 For 12/18K outdoor unit .....	91



**10. Appendix.....101**

10.1 Piping Diagrams.....101

10.2 Wiring Diagrams.....102

10.3 Circuit Diagrams.....106

# 1. Introduction

## 1.1 Safety Cautions

Be sure to read the following safety cautions before conducting repair work.

The caution items are classified into "Warning" and "Caution". The "Warning" items are especially important since they can lead to death or serious injury if they are not followed closely. The "Caution" items can also lead to serious accidents under some conditions if they are not followed. Therefore, be sure to observe all the safety caution items described below.

About the pictograms

△ This symbol indicates an item for which caution must be exercised.

The pictogram shows the item to which attention must be paid.

○ This symbol indicates a prohibited action.





The prohibited item or action is shown inside or near the symbol.







● This symbol indicates an action that must be taken, or an instruction.

The instruction is shown inside or near the symbol.

After the repair work is complete, be sure to conduct a test operation to ensure that the equipment operates normally, and explain the cautions for operating the product to the customer.



### 1.1.1 Caution in Repair

Warning	
<p>Be sure to disconnect the power cable plug from the plug socket before disassembling the equipment for a repair.</p> <p>Working on the equipment that is connected to a power supply can cause an electrical shock.</p> <p>If it is necessary to supply power to the equipment to conduct the repair or inspecting the circuits, do not touch any electrically charged sections of the equipment.</p>	
<p>If the refrigerant gas discharges during the repair work, do not touch the discharging refrigerant gas. The refrigerant gas can cause frostbite.</p>	
<p>When disconnecting the suction or discharge pipe of the compressor at the welded section, release the refrigerant gas completely at a well-ventilated place first.</p> <p>If there is a gas remaining inside the compressor, the refrigerant gas or refrigerating machine oil discharges when the pipe is disconnected, and it can cause injury.</p>	
<p>If the refrigerant gas leaks during the repair work, ventilate the area. The refrigerant gas can generate toxic gases when it contacts flames.</p>	
<p>The step-up capacitor supplies high-voltage electricity to the electrical components of the outdoor unit.</p> <p>Be sure to discharge the capacitor completely before conducting repair work. A charged capacitor can cause an electrical shock.</p>	
<p>Do not start or stop the air conditioner operation by plugging or unplugging the power cable plug.</p> <p>Plugging or unplugging the power cable plug to operate the equipment can cause an electrical shock or fire.</p>	

Warning	
Do not repair the electrical components with wet hands. Working on the equipment with wet hands can cause an electrical shock.	
Do not clean the air conditioner by splashing water. Washing the unit with water can cause an electrical shock.	
Be sure to provide the grounding when repairing the equipment in a humid or wet place, to avoid electrical shocks.	
Be sure to turn off the power switch and unplug the power cable when cleaning the equipment. The internal fan rotates at a high speed, and cause injury.	
Do not tilt the unit when removing it. The water inside the unit can spill and wet the furniture and floor.	
Be sure to check that the refrigerating cycle section has cooled down sufficiently before conducting repair work. Working on the unit when the refrigerating cycle section is hot can cause burns.	
Use the welder in a well-ventilated place. Using the welder in an enclosed room can cause oxygen deficiency.	



### 1.1.2 Cautions Regarding Products after Repair

Warning	
Be sure to use parts listed in the service parts list of the applicable model and appropriate tools to conduct repair work. Never attempt to modify the equipment. The use of inappropriate parts or tools can cause an electrical shock, excessive heat generation or fire.	
When relocating the equipment, make sure that the new installation site has sufficient strength to withstand the weight of the equipment. If the installation site does not have sufficient strength and if the installation work is not conducted securely, the equipment can fall and cause injury.	
Be sure to install the product correctly by using the provided standard installation frame. Incorrect use of the installation frame and improper installation can cause the equipment to fall, resulting in injury.	For integral units only
Be sure to install the product securely in the installation frame mounted on a window frame. If the unit is not securely mounted, it can fall and cause injury.	For integral units only

Warning	
<p>Be sure to use an exclusive power circuit for the equipment, and follow the technical standards related to the electrical equipment, the internal wiring regulations and the instruction manual for installation when conducting electrical work.</p> <p>Insufficient power circuit capacity and improper electrical work can cause an electrical shock or fire.</p>	
<p>Be sure to use the specified cable to connect between the indoor and outdoor units. Make the connections securely and route the cable properly so that there is no force pulling the cable at the connection terminals.</p> <p>Improper connections can cause excessive heat generation or fire.</p>	
<p>When connecting the cable between the indoor and outdoor units, make sure that the terminal cover does not lift off or dismount because of the cable.</p> <p>If the cover is not mounted properly, the terminal connection section can cause an electrical shock, excessive heat generation or fire.</p>	
<p>Do not damage or modify the power cable.</p> <p>Damaged or modified power cable can cause an electrical shock or fire. Placing heavy items on the power cable, and heating or pulling the power cable can damage the cable.</p>	
<p>Do not mix air or gas other than the specified refrigerant (R-410A / R22) in the refrigerant system.</p> <p>If air enters the refrigerating system, an excessively high pressure results, causing equipment damage and injury.</p>	
<p>If the refrigerant gas leaks, be sure to locate the leak and repair it before charging the refrigerant. After charging refrigerant, make sure that there is no refrigerant leak.</p> <p>If the leak cannot be located and the repair work must be stopped, be sure to perform pump-down and close the service valve, to prevent the refrigerant gas from leaking into the room. The refrigerant gas itself is harmless, but it can generate toxic gases when it contacts flames, such as fan and other heaters, stoves and ranges.</p>	
<p>When replacing the coin battery in the remote controller, be sure to disposed of the old battery to prevent children from swallowing it.</p> <p>If a child swallows the coin battery, see a doctor immediately.</p>	

Caution	
<p>Installation of a leakage breaker is necessary in some cases depending on the conditions of the installation site, to prevent electrical shocks.</p>	
<p>Do not install the equipment in a place where there is a possibility of combustible gas leaks.</p> <p>If a combustible gas leaks and remains around the unit, it can cause a fire.</p>	
<p>Be sure to install the packing and seal on the installation frame properly. If the packing and seal are not installed properly, water can enter the room and wet the furniture and floor.</p>	For integral units only

### 1.1.3 Inspection after Repair

Warning	
<p>Check to make sure that the power cable plug is not dirty or loose, then insert the plug into a power outlet all the way.</p> <p>If the plug has dust or loose connection, it can cause an electrical shock or fire.</p>	
<p>If the power cable and lead wires have scratches or deteriorated, be sure to replace them.</p> <p>Damaged cable and wires can cause an electrical shock, excessive heat generation or fire.</p>	





Warning	
<p>Do not use a joined power cable or extension cable, or share the same power outlet with other electrical appliances, since it can cause an electrical shock, excessive heat generation or fire.</p>	

Caution	
<p>Check to see if the parts and wires are mounted and connected properly, and if the connections at the soldered or crimped terminals are secure. Improper installation and connections can cause excessive heat generation, fire or an electrical shock.</p>	
<p>If the installation platform or frame has corroded, replace it. Corroded installation platform or frame can cause the unit to fall, resulting in injury.</p>	
<p>Check the grounding, and repair it if the equipment is not properly grounded. Improper grounding can cause an electrical shock.</p>	
<p>Be sure to measure the insulation resistance after the repair, and make sure that the resistance is 1 M ohm or higher.</p> <p>Faulty insulation can cause an electrical shock.</p>	
<p>Be sure to check the drainage of the indoor unit after the repair.</p> <p>Faulty drainage can cause the water to enter the room and wet the furniture and floor.</p>	

## 1.1.4 Using Icons

Icons are used to attract the attention of the reader to specific information. The meaning of each icon is described in the table below:

## 1.1.5 Using Icons List

Icon	Type of Information	Description
 Note:	Note	A "note" provides information that is not indispensable, but may nevertheless be valuable to the reader, such as tips and tricks.
 Caution	Caution	A "caution" is used when there is danger that the reader, through incorrect manipulation, may damage equipment, lose data, get an unexpected result or has to restart (part of) a procedure.
 Warning	Warning	A "warning" is used when there is danger of personal injury.
	Reference	A "reference" guides the reader to other places in this binder or in this manual, where he/she will find additional information on a specific topic.

## 2. List of Functions

Category	Functions	HSU12VHJ(DB)	HSU18VHJ(DB)
Healthy negative ion	make your room full of an abundance natural negative ions.	Y	Y
Left&right flow	With specialized motor and flaps, the airflow can be adjusted .	N	N
Child lock	Avoid the child's wrong operation on the remote controller	Y	Y
3D air flow	The 3D airflow is able to deliver the airflow horizontally and vertically.	N	N
24Hour timer	Use the timer function to set on,or off,or from on to off,or from off to on	Y	Y
Auto restart	automatic return to previous operation conditions after asudden power blackout	Y	Y
Easy clean design	The panel is easy to wash and the airflow vents can be detached easily	Y	Y
Intelligent air	With single-blade technology ,the airflow can be adjusted not to blow directly	Y	Y
Anti-mold filter	Catches most small particles and remove unpleasant odors effectively.	Y	Y
Sleep mode	The setting temprature and the indoor noise can be adjusted to a more comfortable level when you set the "sleep mode"during night sleep	Y	Y
4 Fan setting	Select the fan speed LO,MED,HI,AUTO	Y	Y
Entire auto mode	You can set a temprature value,with which the unit can be adjusted the operation mode automatically	Y	Y
Auto mode	adjust the last fixed operation mode automatically.	N	N
ESF filter	Trap harmful dust and remove unpleasant odors effectively	N	N
Power mode	Quick cooling or heating	Y	Y
Soft mode	lower noise operation condition	Y	Y
Negative ion filter	Generate negative ions by the filter.	N	N
Constant temperature dehumidification	Make dehumidifying in the room while keeping the constant temperature inside	N	N

Note: Y: Holding Functions

N : No Functions

### 3. Specifications

Model			HSU12VHJ(DB)		HSU18VHJ(DB)	
			Cooling	Heating	Cooling	Heating
Capacity Rated (Min.~Max.)	kW		3.51(0.88-3.95)	3.95(0.88-4.25)	5.27(1.17-5.57)	5.57(1.17-6.00)
	Btu/h		12000(3000-13500)	13500(3000-14500)	18000(4000-19000)	19000(4000-20500)
	kcal/h		3018.6(756.8-3397)	3397(756.8-3655)	4532.2(1006.2-4790.2)	4790.2(1006.2-5160)
Moisture Removal	pints/hr		2.82	—	3.52	—
Running Current (Rated)	A		5.4	5.9	8.0	7.8
Power Consumption Rated (Min.~Max.)	W		1090(250-1450)	1190(250-1450)	1640(270-1900)	1650(270-1950)
Power Factor	%		98	98	98	98
SEER/HSPF			16	9.5	16	9
Piping Connections	Liquid	inches	φ 1/4		φ 1/4	
	Gas	inches	φ 3/8		φ 1/2	
	Drain	inches	φ 5/8		φ 5/8	
Heat Insulation			Both Liquid and Gas Pipes		Both Liquid and Gas Pipes	
Max. Interunit Piping Length	feet		49 1/5		82 1/50	
Max. Interunit Height Difference	feet		32 4/5		49 1/5	
Chargeless	feet		32 4/5		32 4/5	
Amount of Additional Charge of Refrigerant	OZ/Inches		0.018		0.018	
Indoor Unit						
Front Panel Color			White		White	
Air Flow Rate	m <sup>3</sup> /min(cfm)	H	8	8	9	9
		M	7.2	7.2	8.2	8.2
		L	6.3	6.3	7.3	7.3
		SL	4.8	4.8	5.8	5.8
Fan	Type		Cross Flow Fan		Cross Flow Fan	
	Motor Output	W	16		16	
	Speed	Steps	4 Steps, Auto		4 Steps, Auto	
Air Direction Control			Horizontal, Downward		Horizontal, Downward	
Air Filter			Removable / Washable / Mildew Proof		Removable / Washable / Mildew Proof	
Running Current (Rated)	A		0.15	0.15	0.15	0.15
Power Consumption (Rated)	W		33	33	33	33
Temperature Control			Microcomputer Control		Microcomputer Control	
Dimensions (H×W×D)	inches		36 13/14 x 7 1/6 x 10 3/7		41 1/6 x 9 2/5 x 11 3/4	
Packaged Dimensions (H×W×D)	inches		39 7/8 x 10 5/6 x 13		45 x 14 4/9 x 12 21/23	
Weight	lbs		24		32	
Gross Weight	lbs		27.8		36.4	
Operation Sound	H/M/L	dBA	45/42/38	45/42/38	45/42/40	45/42/40
Sound Power	H	dBA	53	53	53	53



Outdoor Unit					
Casing Color		White		White	
Compressor	Type	Rotary Compressor		Rotary Compressor	
	Model	DA89X1C-20FZ		SNB130FGYM2	
	Motor Output	W	650	900	
RefrigerantOil	Model	ESTER OIL VG74		FV50S	
	Charge	pints	0.65	0.88	
Refrigerant	Model	R410a		R410a	
	Charge	oz	35.27	42.33	
Air Flow Rate (H/L)	m <sup>3</sup> /min	31.6	31.6	31.6	31.6
	cfm	1115	1115	1115	1115
Fan	Type	Propeller		Propeller	
	Motor Output	W	80	80	
Running Current (Rated)	A	3.5	3.5	4.9	4.8
Power Consumption (Rated)	W	780	780	1090	1050
Power Factor	%	98	98	98	98
Starting Current	A	20		26	
Dimensions (H×W×D)	inches	21 3/8 x 30 5/6 x 10 2/51		25 1/3 x 30 5/6 x10 2/51	
Packaged Dimensions (H×W×D)	inches	24 1/6 X 36 3/5 X 13 2/5		28 1/9 X 36 3/5 X 13 27/70	
Weight	lbs	72.8		88.2	
Gross Weight	lbs	79.4		97	
OperationSound	H/L	dBA	53	49	53
Sound Power	H	dBA	63	59	63

Note: The data are based on the conditions shown in the table below.

Cooling	Heating	Piping Length
Indoor ; <b>80° FDB/67° FWB</b> Outdoor ; <b>95° FDB/75° FWB</b>	Indoor ; <b>70° FDB/60° FWB</b> Outdoor ; <b>47° FDB/47° FWB</b>	16 2/5 feet

Conversion Formulae
kcal/h=kW×860
Btu/h=kW×3414
cfm=m <sup>3</sup> /min×35.3

## 4. Printed Circuit Board Connector Wiring Diagram

### 4.1 : Indoor unit Connectors

FOR 12K

#### Connectors

##### PCB(1) (Control PCB)

- 1) CN26 Connector for fan motor
- 2) CN11 Connector for STEP motor
- 3) CN8 Connector for heat exchanger thermistor and Room temperature thermistor
- 4) CN27 Connector for fan feedback
- 5) CH1 Connector for power L wire
- 6) CON2 Connector for power N wire
- 7) CON7 Connector for communicate wire
- 8) CN30 Connector for transformer input
- 9) CN31 Connector for transformer output
- 10) CN32 Connector for display board

#### Note: Other designations

PCB(1) (INdoor Control PCB)

- 1) CN48 Connector for Forced operation ON / OFF switch
- 2) J1 Select 25 or 35
- 3) LED1 communicate display light
- 4) RV1 Varistor
- 5) FUSE1 Fuse 3.15A/250VAC

PCB(1)

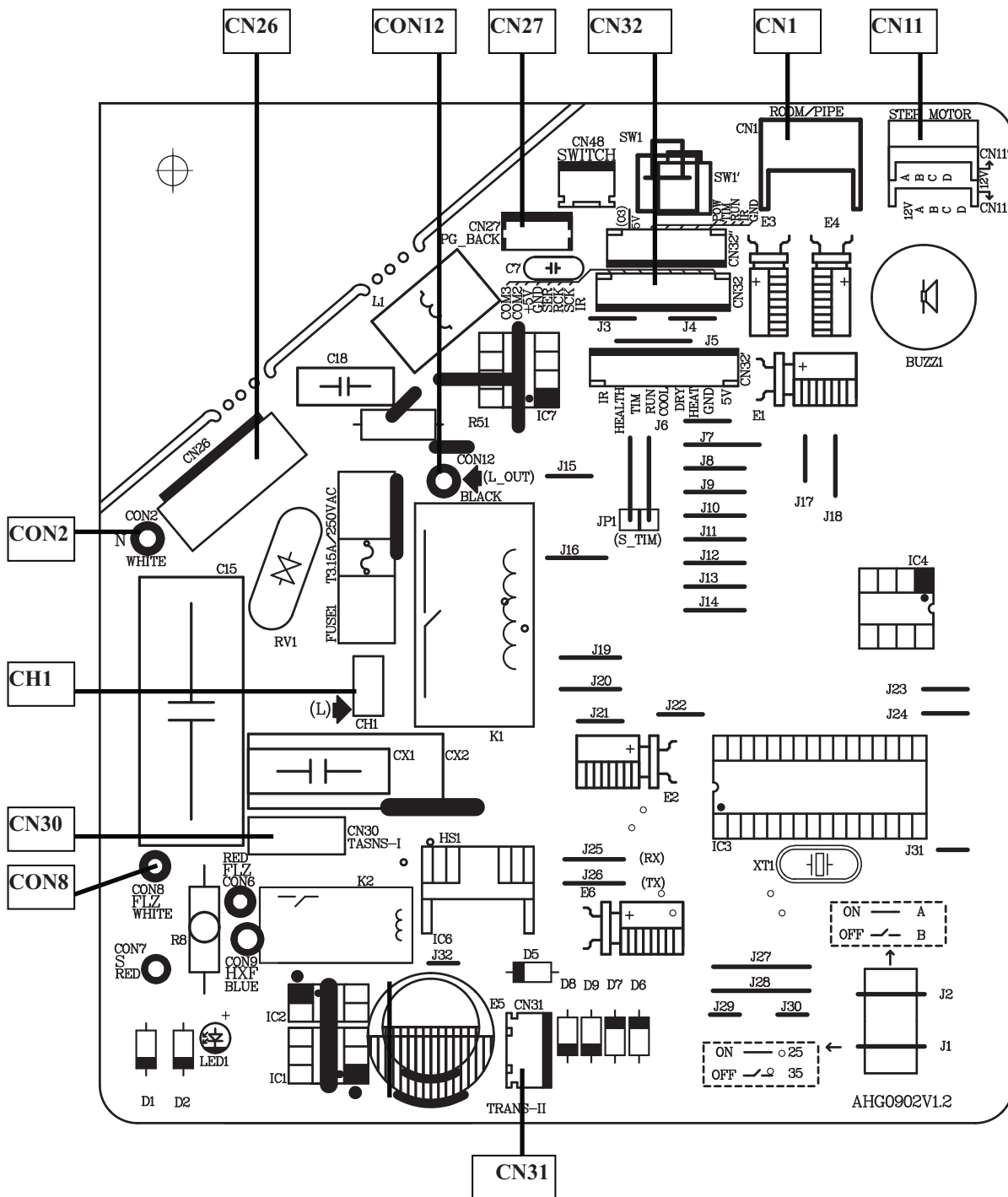

FOR 18K

### Connectors

#### PCB(1) (Control PCB)

- 1) CN26 Connector for fan motor
- 2) CN1 Connector for heat exchanger thermistor and Room temperature thermistor
- 3) CN11 Connector for UP&DOWN STEP motor
- 4) CON2 Connector for power N wire
- 5) CON1 Connector for power L
- 6) CN32 Connector for display board
- 7) C0N6 C0N8 Connector for ions generator
- 8) C0N7 Connector for communicate between the indoor board and the outdoor board

#### Note: Other designations

##### PCB(1) (INdoor Control PCB)

- 1) CN48 Connector for Forced operation ON / OFF switch
- 2) J1 Select 25 or 35
- 3) LED1 communicate display light
- 4) RV1 Varistor
- 5) FUSE1 Fuse 3.15A/250VAC

# PCB(1)

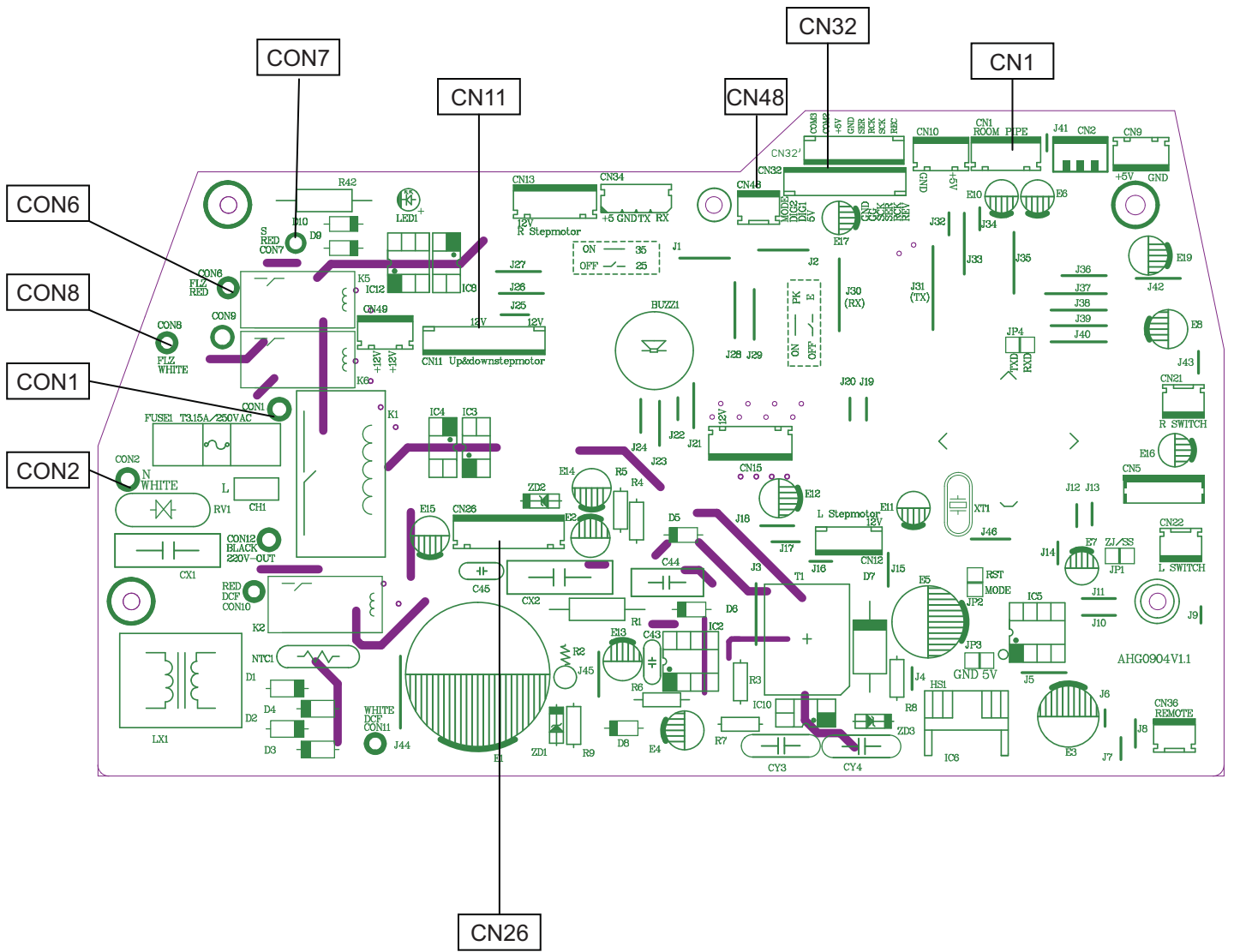

## 4.2 : Outdoor unit

### FOR12K

#### Connectors

##### PCB(1) (Control PCB)

- 1) CN1 CN2 Connector for power N and L
- 2) CN3 Connector for ground
- 3) CN22 Connector for DC POWER 15V and 5V to the module board
- 4) CN16 Connector for electric expansion valves
- 5) CN21 Connector for DC fan motor
- 6) CN10 Connector for four way valve coil
- 7) CN17 CN18 CN19 CN20 Connector for thermistors  
(CN20: outdoor air CN19: heat exchanger CN18 :SUCK thermistors CN17 :discharge pipe)
- 8) CN23 Connector for communicate between the control board and the module board
- 9) CN25 CN8 Connector for the L N to the module board
- 10) CN4 Connector for communicate between the indoor board and the outdoor board
- 11) CN26 Connector for capacitance anode
- 12) CN24 Connector for capacitance cathode

##### PCB(2) (module PCB)

- CN10 Connector for the DC power 5V and 15V from the control PCB
- CN11 Connector for communicate between the control board and the module board
- P( CN1) N(CN5) Connector for capacitance board
- LI (CN7) LO(CN6) Connector for reactor
- CN2 CN3 CN4 Connector for the U V W wire of the compressor

#### **Note:** Other Designations

##### PCB(1) (Control PCB)

- 1) FUSE 1 (25A,250VAC) FUSE 2(1A,250VAC)
- 2)LED 1 keep light representative normal ,if keep flash interval representative trouble Alarm
- 3)RV1 RV2 RV3 Varistor



PCB(2)

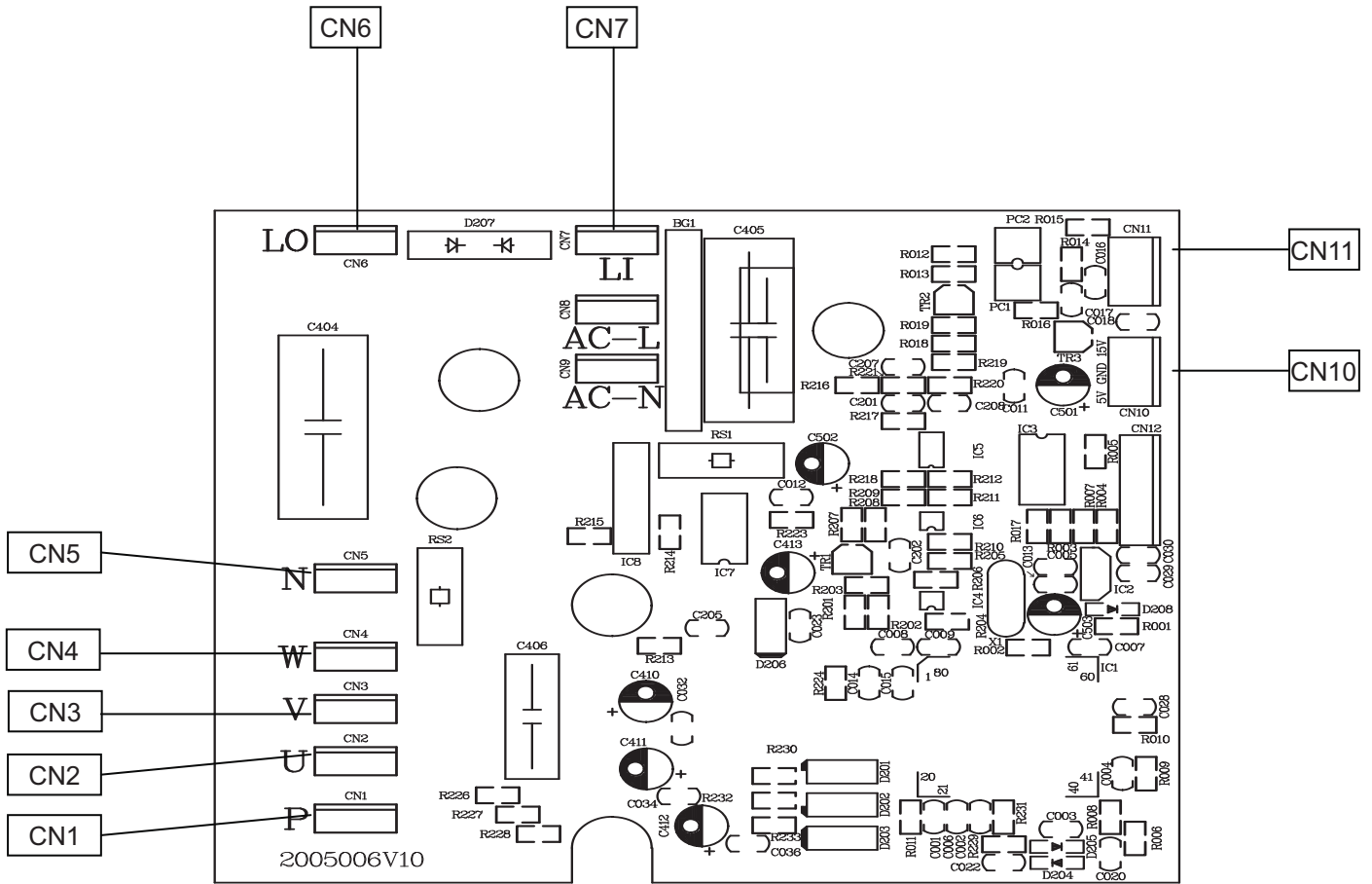



**FOR 18K****Connectors****PCB(1) (Control PCB)**

- 1) CN1 CN2 Connector for power N and L
- 2) CN3 Connector for ground
- 3) CN22 Connector for DC POWER 15V and 5V to the module board
- 4) CN16 Connector for electric expansion valves
- 5) CN21 Connector for DC fan motor
- 6) CN10 Connector for four way valve coil
- 7) CN17 CN18 CN19 CN20 Connector for thermistors  
(CN20: outdoor air CN19: heat exchanger CN18 :SUCK thermistors CN17 :discharge pipe)
- 8) CN23 Connector for communicate between the control board and the module board
- 9) CN25 CN8 Connector for the L N to the module board
- 10) CN4 Connector for communicate between the indoor board and the outdoor board
- 11) CN26 Connector for capacitance anode
- 12) CN24 Connector for capacitance cathode

**PCB(2) (module PCB)**

- CN10 Connector for the DC power 5V and 15V form the control PCB
- CN11 Connector for communicate between the control board and the module board
- P( CN1) N(CN5) Connector for capacitance board
- LI (CN7) LO(CN6) Connector for reactor
- CN2 CN3 CN4 Connector for the U V W wire of the compressor

**Note:** Other Designations

## PCB(1) (Control PCB)

- 1) FUSE 1 (25A,250VAC) FUSE 2(1A,250VAC)
- 2)LED 1 keep light representative normal if keep flash interval representative trouble Alarm
- 3)RV1 RV2 RV3 Varistor



PCB(2)

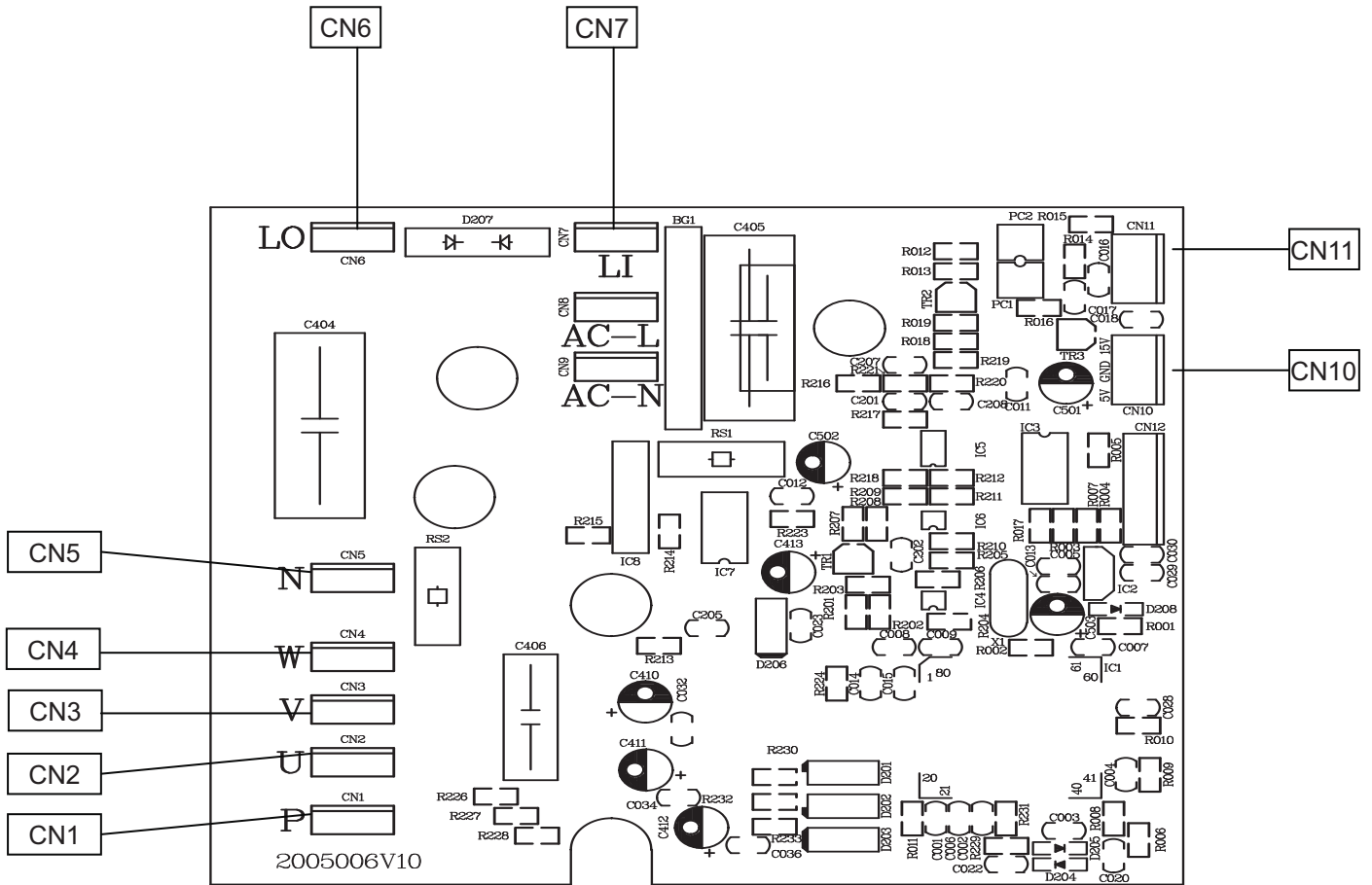

# 5.Functions and Control

## 5.1 Main functions and control specification of indoor unit

This specification use for HSU12/18VHJ(DB) frequency conversion air condition are manufactured by Haier air condition parent company. "Setting value" (express in parameter) in this specification means is a parameter that is stored in EEPROM. Refer to [EEPROM parameter table].

### 5.1.1 Temperature Adjusting function

#### 5.1.1.1 Temperature adjusting of different levels.

(DASH operation conditions under different modes)

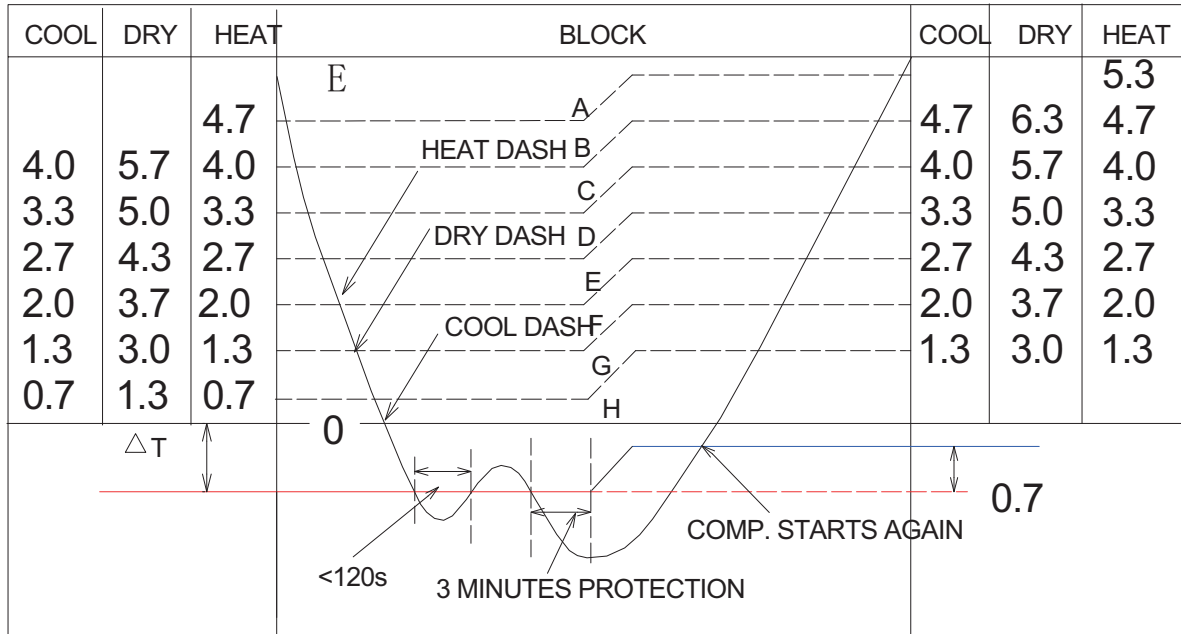

#### 5.1.1.2 Select the wind volume when it is set automatic

When the wind volume is automatic, it can be switched between strong, medium and weak according to the temperature adjusting levels.

Wind volume under the automatic wind volume mode

	Temperature adjusting levels								
	A	B	C	D	E	F	G	H	I
Heating	Strong	Strong	Strong	Strong	Strong	Medium	Weak	Weak	SLO
cooling		Strong	Strong	Strong	Medium	Medium	Weak	Weak	Weak
Moisture removing		Strong	Medium	Medium	Medium	Weak	Weak	SLO	SLO

### 5.1.1.3 Wind volume limit

When the compressor is working and the max setting for indoor fan motor is medium or weak, the upper limit of indicated frequency is as follows:

Frequency control form for wind volume

	Limited frequency variables	Limited frequency
Medium wind volume	FQLIMMD	70Hz
Weak wind volume	FQLIMLO	58Hz
Limited frequency for up/down health wind	FUPHEAL	48Hz

## 5.1.2 Main functions

### 5.1.2.1 Warm boot

When the heat running starts or the frost removing ends and the compressor starts again, in order to avoid cold wind, warm boot wind volume control should be done.

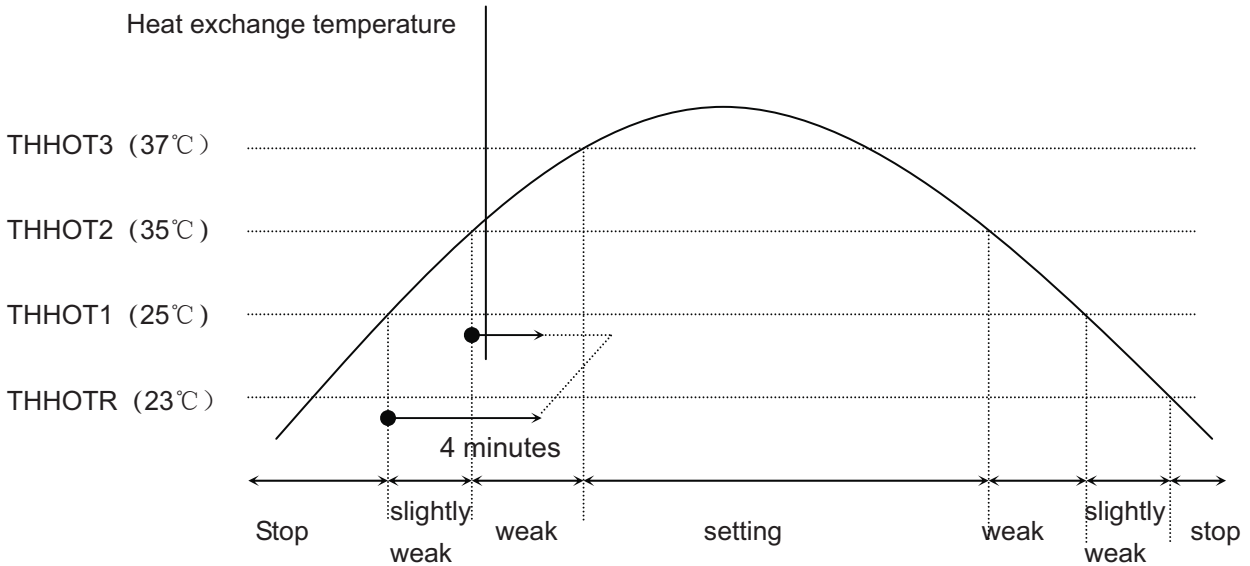

To control the indoor fan motor as shown in the table above according to the heat exchange temperature

The fan motor stops when the heat exchange temperature is below 25°C

The fan motor is working slightly weak when the heat exchange temperature is above 25 °C and below 35°C

The fan motor is working weak when the heat exchange temperature is above 35 °C and below 37°C

The fan motor works as set if the heat exchange temperature remains above 38°C

### 5.1.2.2 When the compressor stops and remains idle for 3 minutes

20 seconds after the compressor stops, the up wind volume is weak (switching to SSLO in silent running mode) and then slightly weak. While the down wind volume is stopped. If the compressor stops when the heat running starts, the wind volume is weak.

### 5.1.2.3 Dehumidification running

Under the dehumidification mode the fan motor stops as the compressor stops.

The operation is weak after 3 minutes' idle mode.

After stand by for 3 minutes, the compressor is on.

The compressor operates as the set wind volume when the wind volume is set to be strong, medium or weak.

The wind volume is decided according to the temperature adjusting when the wind volume is set to be automatic.

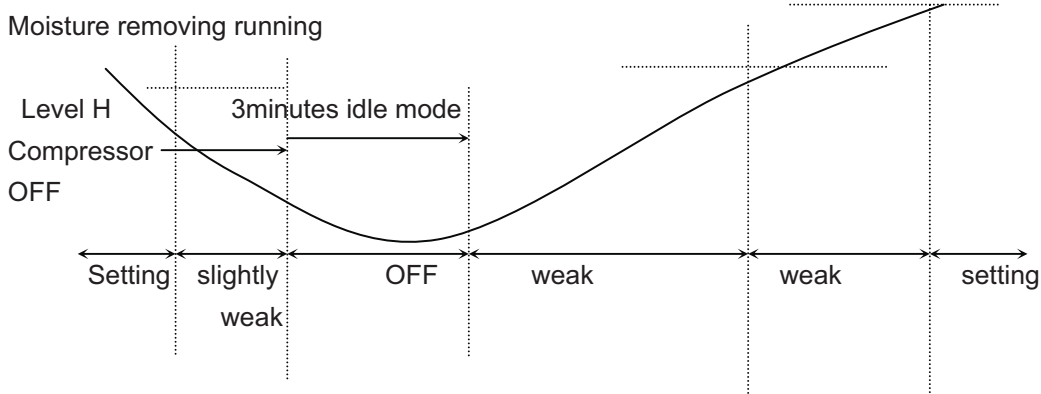

### 5.1.2.4 Automatic running

When the running mode is turned to automation after starting the system, the system will first determine the running mode according to the current room temperature and then will run according to the determined mode.  $T_r$  in the following selection conditions means room temperature,  $T_s$  means setting temperature,  $T_p$  means temperature of indoor coil pipe.

$T_r \geq 23^\circ\text{C}$  Choose Cooling Mode

$T_r < 23^\circ\text{C}$  Choose Heating Mode

After turning to the automation mode, the running mode can be switched between cooling mode, fan mode and heating mode according to the change of the indoor ambient temperature. But the automatic conversion between cooling mode and heating mode must be conducted after 15 minutes.

## 5.1.3 Special functions

### 5.1.3.1 Powerful running

Powerful running for 15 minutes

The running stops or ends the powerful running after 15 minutes

The mode switch ends the powerful running

Enter into the silent mode, normal running mode or timed switching on mode to end the powerful running

When in automatic mode, there are powerful and silent functions for your choice. When the main unit

is in cooling mode, it operates with powerful cooling or silent cooling. When the main unit is in heating mode, it operates with powerful heating or silent heating. When the main unit is in wind-sending mode, there are no powerful or silent modes.

There is no powerful mode for wind-sending and moisture removing

#### **Powerful heating:**

Change the set temperature. With temperature adjusting function

The wind volume is the automatic medium

When in frost removing mode, the outdoor unit does not accept the communication signal for powerful running

After 15 minutes of powerful running, the compressor can not be off within 10 minutes

#### **Powerful cooling:**

Change the set temperature. With temperature adjusting function

The wind volume is the automatic strong

After the compressor starts, there will be no low-intense running protection within 3 minutes

### **5.1.3.2 Silent running**

Send the silent running signal to the outdoor unit

Under the Silent heating mode, The wind volume is SSLO after the compressor is on, The wind volume will be kept SSLO within 20 seconds after the compressor stops and then changes to weak

Under the Silent cooling mode the wind volume is SSLO

There is no silent mode for moisture removing and wind-sending.

### **5.1.3.3 Air cleaning**

If the fan motor starts working after receiving the remote-control order, the aion generator starts working and sends out ions.

The ion generator stops as the fan motor stops.

When the ion generator is OFF and the air cleaning function is on, the fan motor starts running and the ion generator starts working again.

### **5.1.3.4 Timed running**

Set the time duration according to the time difference between the clock for timing and the current clock

In timing mode, the display panel will flash the light at fixed times

<b>Timed OFF</b>	When this function is set, operation modes on the panel display will not change. The timing icon will show and the operation stops when the set time comes.
<b>Timed ON</b>	When this function is on, the panel display will only display a question mark. The unit will operate as the set mode when the time comes.
<b>Timed ON/OFF</b>	The unit will start operating or stop according to the order of your setting.

### 5.1.3.5 Sleeping function

a. After setting the sleeping function, the refrigerating mode and dehumidification mode will run as per the following rules:

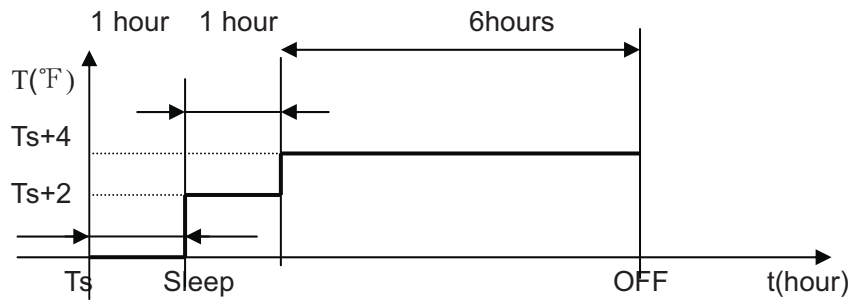

b. After setting the sleeping function, the heating mode will run as per the following rules:

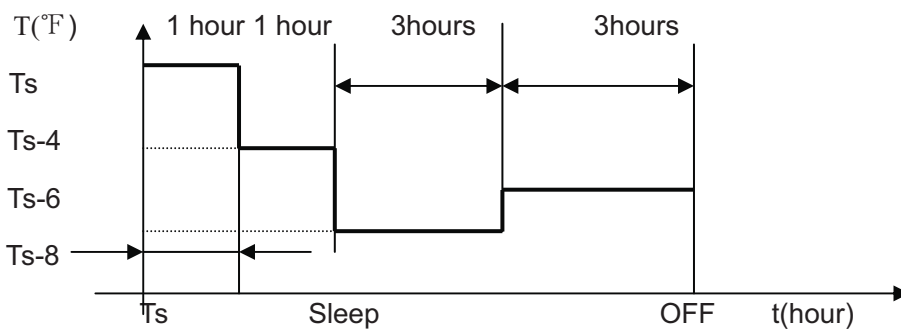

As shown in the above diagram, after running for 1 hour under refrigerating mode and dehumidification mode, the setting temperature will increase about  $2^{\circ}\text{F}$ ; after another 1 hour, it will increase about  $2^{\circ}\text{F}$  again, and after 6 hours, it will cease; after running for 1 hour under heating mode, the setting temperature will decrease about  $4^{\circ}\text{F}$ , after another 1 hour, it will decrease the about  $4^{\circ}\text{F}$  again, and after 3 hours, it will increase about  $2^{\circ}\text{F}$ , and after other 3 hours, it will cease.

### 5.1.3.6 Trial running

The indicated frequency for trial running is 58Hz, wind volume is strong.

The trial running will last for 30 minutes and then the unit will be powered off. The unit will exit the trial running if it receives any remote-control signal during the trial running period.

There is no low-intense running protection.

### 5.1.3.7 Power failure compensation

To enter into the function please press the sleep key 10 times with 4 beeps in 7 seconds

Under the power failure compensation mode, unplug and plug again, the indoor unit will resume original operation

Under the power failure compensation mode, unplug and plug again, the unit will be on OFF state.

Mode, Fan speed, Healthy, Set temperature can be memoried. Swing, Timer, Sleep cannot be memoried

Press the sleep key for 10 times with 2 beeps in 7 seconds to exit.



### 5.1.3.8 Rated Operation

Rated Cooling:

When receiving the instruction of indoor unit rated operation, the unit will start rated cooling operation.

Rated Heating:

When receiving the instruction of indoor unit rated operation, the unit will start rated heating operation.

---

## 5.2 Main functions and control specification of outdoor unit

Sensor Code Definition: Tai= Indoor Ambient Temperature, Tao=Outdoor Ambient Temperature, Tc1=Indoor Coil, Td= Air Discharge, Te= Outdoor Coil, Ts=Air Intake

### 5.2.1 Outdoor Unit Operation Frequency and Control

#### Compressor Operation Frequency Range

Compressor Operation Frequency Range:

Outdoor Temperature	$\leq 4$	4 ~ 18	$\geq 18$
Heating (Hz)	20 ~ 110	20 ~ 90	20 ~ 53
Defrosting (Hz)	80		
Outdoor Temperature	$\leq 23$	23 ~ 32	$\geq 32$
Cooling (Hz)	20 ~ 50	20 ~ 70	20 ~ 95

#### Compressor Startup

Regardless of target frequency of indoor unit, each time when compressor is from off to on, it must maintain 60Hz,90Hz for one minute (Frequency will be immediately decreased under the condition that outdoor unit air discharge temperature overheating protection is activated or over current of compressor) then the compressor will operate towards target frequency. This process does not exist in normal operation of unit.

#### Heating

When completing compressor startup operation, it will operate as per frequency of indoor unit. After 2 minutes, compressor operation frequency will be compensated as per relevant conditions.

#### Cooling & Dehumidification:

When completing compressor startup operation, it will operate as per frequency of indoor unit. After 2 minutes, compressor operation frequency will be compensated as per relevant conditions.

#### Compressor Frequency Increase/Decrease Speed

Rapid Frequency Increase/Decrease Speed 1 -----1Hz/s

Slow Frequency Increase/Decrease Speed 2 -----1Hz/10s

## 5.2.2 Outdoor fan control

**Compressor startup within 3min ,outdoor fan speed control as follows:**

Outdoor Temperature	<10	10~25	≥ 25
Cooling/ Dehumidification	1	3	7
Heating	5	3	2

**After compressor runs 3min ,outdoor fan speed control as follows:**

Cooling/ Dehumidification:

Compressor Operation Frequency ( Hz )		<25	25 ~ 45	≥45
Tao ( °C )	32 ~ 38	3	4	7
	23~32	1	2	5
	<23			
	≥38	7		

Heating:

Compressor Operation Frequency (Hz)		<25	25 ~ 45	≥45
Tao ( °C )	≤4	3	4	7
	4~18	2	4	7
	≥18	1		

### Compressor shutdown and outdoor fan residual heat blow process

When compressor shuts down in cooling mode, outdoor fan automatically jumps to low speed and blows residual heat for 30s and stop.

## 5.2.3 Four-way Valve Control

Defrosting Four-way Valve Control, (please see defrosting process for details)

Time sequence of the defrosting operation is as follows:

Four-way Valve Work Status in Other Modes:

In heating mode, four-way valve is on. If compressor is off or is switched to non-heating mode, four-way valve ensures that it is off at least 2 minutes after compressor shuts down.

## 5.2.4 Outdoor Defrosting Control

### Defrosting Mode Entry Conditions

The unit will enter defrosting mode when compressor starts up and operates for 10 minutes continuously in heating mode or after compressor runs for an accumulated time of 45 minutes (Upon completion of defrosting or when switched to cooling mode, compressor accumulated operation time will be cleared) and when 2 minutes' continuous checking by defrosting sensor TE (check frosting condition of outdoor unit heat exchanger) and outdoor ambient temperature sensor TA meets the following conditions:

$$TE \leq C \times TA - \alpha$$

Among which:  $C: TA < 0^\circ\text{C}$ ,  $C=0.8$

$$TA \geq 0^\circ\text{C}, C=0.6$$

For area prone to frost, the value is set at 6 when unit leaves the factory.

Defrosting entry temperature control  $-15^\circ\text{C} \leq C \times TA - \alpha \leq 5^\circ\text{C}$

---

### Defrosting Time Interval

time interval between two defrosting cycles is 45 minutes.

### Defrosting Operation

When defrosting begins, compressor will stop for one minute, external fan is running and 50s later, four-way valve will be off.

When compressor starts, external fan will be off, compressor will run at 58Hz for 60s then move on to target frequency of 88Hz.

During defrosting, compressor current and air discharge overheat protection features are effective.

During defrosting, if compressor shuts down due to activation of protection feature or due to malfunction, it will resume after 3 minutes. In the unit is still within defrosting cycle, it will resume defrosting and startup of compressor will be based on the rule for defrosting startup. (The unit will exit defrosting mode and handle fault in the event of 3 consecutive restart failures.)

On entering defrosting, it must guarantee that compressor will operate for a minimum of 2 minutes in defrosting mode before exit.

---

### Defrosting Exit Condition

When one of the following conditions is met, defrosting operation will be switched to heating operation.

- (1) : Temperature of outdoor heat exchanger exceeds  $7^\circ\text{C}$  for 80s continuously
  - (2) : Temperature of outdoor heat exchanger exceeds  $12^\circ\text{C}$  for 5s continuously
  - (3) : Defrosting operation continues for 11 minutes.
- 

### When defrosting exit conditions are met, the unit will operate as follows

Compressor stops and external fan starts, 50s later, four-way valve will be on, 60s later, compressor will operate as per startup process.

---

## 5.2.5 PTC Output Control

When outdoor unit is energized, PTC output value is 0, 10s later, output value is 1.

When compressor stops for 10 minutes continuously, PTC output value is 0.

On receiving compressor startup instruction, initial PTC output is 1, and compressor startup will be performed 5s later.

---

## 5.2.6 System Protection Function

### 5.2.6.1 3 minutes stand-by time

Time interval between compressor shutdown and restart is set at 3 minutes to ensure that compressor will only restart after 3-minute shutdown and initial energization valves are turned on to adequate opening position after being fully turned off.

### 5.2.6.2 TD High Temperature Protections

As long as unit is on, the TD air discharge overheating protection feature will be activated, yet air discharge sensor fault must be alarmed 4 minutes after compressor starts.

TD (°C)

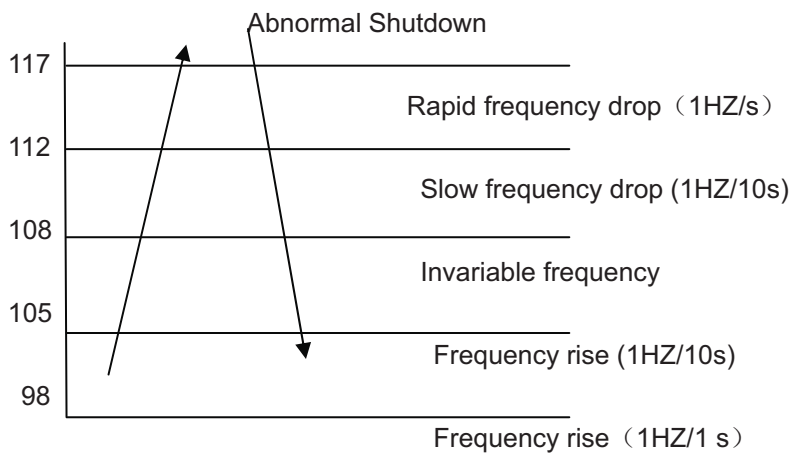

When TD > 117°C for 20s continuously, air discharge overheating protection will be activated and fault will be reported to indoor unit.

It will not continue in other conditions.

### 5.2.6.3 Indoor Heat Exchanger Anti-freeze Protection

Anti-freeze during cooling

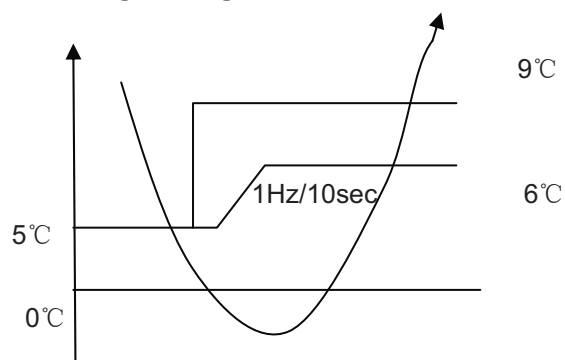

When TC < 5°C, compressor frequency will drop at a speed of 1HZ/10s

When TC starts to rise, and 6 ≤ TC ≤ 9°C, compressor frequency will remain unchanged.

When 9 < TC < 11°C, frequency will rise normal.

If TC ≤ 0°C, for 2 consecutive minutes, compressor will shutdown and outdoor fault lamp blinks. Fault will not be reported to indoor unit.

When compressor shuts down for more than 3 minutes, and when TC > 9°C, compressor will restart.

#### 5.2.6.4 Outdoor Temperature Limit

Cooling: When outdoor temperature is lower than 23°C, cooling operation will start, compressor frequency is limited to less than 50 HZ, outdoor wind speed is forced at level 1.

Heating: When outdoor temperature is higher than 18°C, heating operation will start, compressor frequency is limited to less than 53 HZ, outdoor wind speed is forced at level 1.

---

#### 5.2.6.5 Special Features

1. Forced Cooling: When receiving indoor forced cooling signal, cooling operation will start in a frequency signaled by indoor unit. Only air discharge temperature and over current protection features are effective and other protection features are invalid.

2. Rated, Middle and Minimum Capacity Operation: When receiving indoor, rated, middle and minimum capacity operation signal, outdoor unit will operate as per wind speed and frequency set by EEPROM and all the protection features are effective.

---

#### 5.2.6.6 Fault Display and Treatment

In case outdoor unit faults, the alarm indicator lamp will blink and blink frequency is 1HZ, Time interval between blink cycles is 3s.

Alarm indicator lamp is off when there is no fault.

## 5.3 Function of Main Thermistor

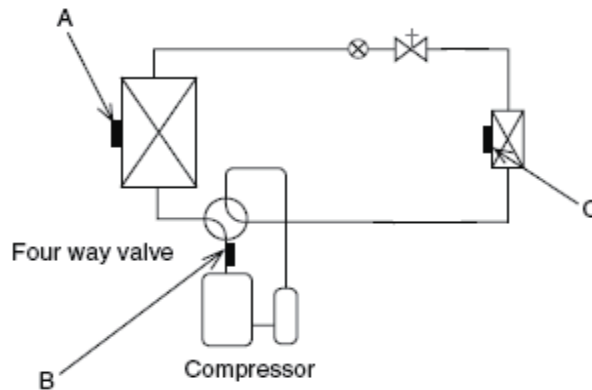

**Note:** A: Outdoor suction temperature sensor

B: Exhaust temperature sensor

C: Indoor heat-exchange sensor

### Outdoor Suction Temperature Sensor

The outdoor heat exchanger thermistor is used for controlling target discharge temperature. The system sets a target discharge temperature according to the outdoor and indoor heat exchanger temperature, and controls the electronic expansion valve opening so that the target discharge temperature can be obtained.

### Exhaust Temperature Sensor

The discharge pipe thermistor is used for controlling temperature of the discharge pipe. If the temperature of discharge pipe (used in place of the inner temperature of the compressor) rises abnormally, the operating frequency drops or the operation halts.

### Indoor heat-exchange sensor

1. The indoor heat exchanger thermistor is used for controlling target discharge temperature.

The system sets a target discharge temperature according to the outdoor and indoor heat exchanger temperature, and controls the electronic expansion valve opening so that the target discharge temperature can be obtained.

2. The indoor heat exchanger thermistor is used for preventing freezing. During the cooling operation, if the temperature drops abnormally, the operating frequency becomes lower, then the operation halts.

3. The indoor heat exchanger thermistor is used for anti-icing control. During the cooling operation, if the heat exchanger temperature in the room where operation is halted becomes  $-1^{\circ}\text{C}$ , it is assumed as icing.

## 5.4 Value of Thermistor

### 5.4.1 indoor Unit

#### Room sensor

$R_{25^{\circ}\text{C}}=23\text{K}\Omega\pm 3.5\%$

$B_{25^{\circ}\text{C}/50^{\circ}\text{C}}=4200\text{K}\pm 3\%$

Temp.(°C)	Max.(KΩ)	Normal(KΩ)	Min.(KΩ)	Tolerance(°C)	
-30	568.8372	501.0746	440.8435	-1.97	1.75
-29	530.9600	468.6491	413.1441	-1.95	1.74
-28	495.8488	438.5314	387.3645	-1.93	1.72
-27	463.2850	410.5433	363.3602	-1.91	1.71
-26	433.0683	384.5212	340.9980	-1.90	1.70
-25	405.0156	360.3153	320.1558	-1.88	1.69
-24	378.9588	337.7879	300.7211	-1.86	1.67
-23	354.7440	316.8126	282.5905	-1.84	1.66
-22	332.2300	297.2732	265.6686	-1.82	1.64
-21	311.2873	279.0627	249.8676	-1.80	1.63
-20	291.7969	262.0831	235.1067	-1.78	1.62
-19	273.6494	246.2437	221.3111	-1.76	1.60
-18	256.7445	231.4612	208.4122	-1.74	1.59
-17	240.9897	217.6590	196.3462	-1.72	1.57
-16	226.3000	204.7662	185.0545	-1.70	1.56
-15	212.5973	192.7176	174.4829	-1.68	1.54
-14	199.8093	181.4531	164.5813	-1.66	1.53
-13	187.8698	170.9169	155.3033	-1.64	1.51
-12	176.7176	161.0578	146.6059	-1.62	1.49
-11	166.2961	151.8284	138.4495	-1.60	1.48
-10	156.5532	143.1847	130.7973	-1.58	1.46
-9	147.4409	135.0863	123.6153	-1.56	1.44
-8	138.9148	127.4956	116.8717	-1.53	1.43
-7	130.9337	120.3778	110.5374	-1.51	1.41
-6	123.4597	113.7009	104.5852	-1.49	1.39
-5	116.4577	107.4349	98.9897	-1.47	1.38
-4	109.8953	101.5523	93.7278	-1.45	1.36
-3	103.7422	96.0274	88.7774	-1.43	1.34
-2	97.9708	90.8365	84.1185	-1.40	1.32
-1	92.5551	85.9574	79.7322	-1.38	1.30
0	87.4712	81.3697	75.6011	-1.36	1.29
1	82.6970	77.0544	71.7088	-1.34	1.27
2	78.2118	72.9937	68.0402	-1.31	1.25
3	73.9966	69.1712	64.5813	-1.29	1.23
4	70.0335	65.5716	61.3188	-1.27	1.21
5	66.3062	62.1807	58.2405	-1.24	1.19
6	62.7992	58.9853	55.3351	-1.22	1.17
7	59.4984	55.9729	52.5917	-1.20	1.15



8	56.3905	53.1320	50.0006	-1.17	1.13
9	53.4631	50.4521	47.5523	-1.15	1.11
10	50.7048	47.9230	45.2384	-1.13	1.09
11	48.1049	45.5355	43.0505	-1.10	1.07
12	45.6534	43.2808	40.9813	-1.08	1.04
13	43.3410	41.1509	39.0236	-1.05	1.02
14	41.1592	39.1381	37.1708	-1.03	1.00
15	39.0998	37.2355	35.4167	-1.00	0.98
16	37.1553	35.4363	33.7555	-0.98	0.96
17	35.3186	33.7344	32.1818	-0.95	0.94
18	33.5833	32.1240	30.6905	-0.93	0.91
19	31.9432	30.5997	29.2769	-0.90	0.89
20	30.3925	29.1565	27.9365	-0.88	0.87
21	28.9259	27.7895	26.6651	-0.85	0.84
22	27.5383	26.4944	25.4589	-0.83	0.82
23	26.2252	25.2670	24.3140	-0.80	0.80
24	24.9822	24.1034	23.2271	-0.78	0.77
25	23.8050	23.0000	22.1950	-0.78	0.77
26	22.7500	21.9499	21.1520	-0.78	0.78
27	21.7477	20.9536	20.1638	-0.82	0.81
28	20.7951	20.0081	19.2272	-0.86	0.85
29	19.8895	19.1104	18.3394	-0.89	0.88
30	19.0285	18.2581	17.4974	-0.93	0.92
31	18.2094	17.4484	16.6988	-0.97	0.95
32	17.4302	16.6792	15.9410	-1.00	0.99
33	16.6885	15.9480	15.2217	-1.04	1.02
34	15.9825	15.2530	14.5389	-1.08	1.06
35	15.3103	14.5920	13.8903	-1.12	1.09
36	14.6700	13.9632	13.2743	-1.16	1.13
37	14.0599	13.3650	12.6889	-1.20	1.16
38	13.4786	12.7957	12.1325	-1.23	1.20
39	12.9244	12.2537	11.6035	-1.27	1.24
40	12.3960	11.7375	11.1004	-1.31	1.27
41	11.8921	11.2459	10.6218	-1.35	1.31
42	11.4113	10.7775	10.1665	-1.39	1.34
43	10.9526	10.3311	9.7330	-1.43	1.38
44	10.5147	9.9056	9.3204	-1.48	1.42
45	10.0967	9.4999	8.9275	-1.52	1.45
46	9.6976	9.1130	8.5532	-1.56	1.49
47	9.3163	8.7439	8.1965	-1.60	1.53
48	8.9521	8.3916	7.8566	-1.64	1.57
49	8.6040	8.0554	7.5327	-1.68	1.60
50	8.2713	7.7345	7.2237	-1.73	1.64
51	7.9531	7.4280	6.9291	-1.77	1.68
52	7.6489	7.1353	6.6480	-1.81	1.72

53	7.3580	6.8556	6.3797	-1.85	1.76
54	7.0796	6.5884	6.1237	-1.90	1.79
55	6.8131	6.3329	5.8793	-1.94	1.83
56	6.5581	6.0887	5.6459	-1.99	1.87
57	6.3140	5.8552	5.4230	-2.03	1.91
58	6.0802	5.6318	5.2100	-2.07	1.95
59	5.8563	5.4181	5.0065	-2.12	1.99
60	5.6417	5.2136	4.8120	-2.16	2.03
61	5.4361	5.0178	4.6260	-2.21	2.07
62	5.2391	4.8304	4.4481	-2.25	2.11
63	5.0502	4.6510	4.2780	-2.30	2.15
64	4.8691	4.4791	4.1153	-2.35	2.19
65	4.6954	4.3145	3.9596	-2.39	2.23
66	4.5287	4.1567	3.8105	-2.44	2.27
67	4.3689	4.0055	3.6678	-2.49	2.31
68	4.2154	3.8605	3.5312	-2.53	2.35
69	4.0682	3.7216	3.4004	-2.58	2.39
70	3.9268	3.5883	3.2750	-2.63	2.43
71	3.7910	3.4605	3.1549	-2.68	2.48
72	3.6606	3.3378	3.0398	-2.73	2.52
73	3.5353	3.2201	2.9294	-2.77	2.56
74	3.4150	3.1072	2.8237	-2.82	2.60
75	3.2993	2.9987	2.7222	-2.87	2.64
76	3.1881	2.8946	2.6249	-2.92	2.68
77	3.0812	2.7946	2.5316	-2.97	2.73
78	2.9785	2.6986	2.4420	-3.02	2.77
79	2.8796	2.6063	2.3560	-3.07	2.81
80	2.7845	2.5176	2.2735	-3.12	2.86
81	2.6931	2.4324	2.1943	-3.17	2.90
82	2.6050	2.3505	2.1182	-3.22	2.94
83	2.5203	2.2717	2.0451	-3.28	2.99
84	2.4388	2.1960	1.9749	-3.33	3.03
85	2.3602	2.1231	1.9075	-3.38	3.07
86	2.2846	2.0530	1.8426	-3.43	3.12
87	2.2118	1.9856	1.7803	-3.48	3.16
88	2.1416	1.9207	1.7204	-3.54	3.20
89	2.0740	1.8582	1.6628	-3.59	3.25
90	2.0089	1.7981	1.6074	-3.64	3.29
91	1.9461	1.7402	1.5541	-3.70	3.34
92	1.8856	1.6844	1.5028	-3.75	3.38
93	1.8272	1.6307	1.4535	-3.80	3.43
94	1.7709	1.5789	1.4060	-3.86	3.47
95	1.7166	1.5291	1.3603	-3.91	3.52
96	1.6643	1.4810	1.3163	-3.97	3.56

97	1.6138	1.4347	1.2739	-4.02	3.61
98	1.5650	1.3900	1.2331	-4.08	3.66
99	1.5180	1.3470	1.1937	-4.13	3.70
100	1.4726	1.3054	1.1559	-4.19	3.75
101	1.4287	1.2654	1.1194	-4.24	3.80
102	1.3864	1.2268	1.0842	-4.30	3.84
103	1.3455	1.1895	1.0503	-4.36	3.89
104	1.3060	1.1535	1.0176	-4.42	3.94
105	1.2679	1.1188	0.9860	-4.47	3.98
106	1.2310	1.0853	0.9556	-4.53	4.03
107	1.1954	1.0529	0.9263	-4.59	4.08
108	1.1610	1.0217	0.8980	-4.65	4.13
109	1.1277	0.9915	0.8707	-4.70	4.17
110	1.0955	0.9624	0.8443	-4.76	4.22
111	1.0644	0.9342	0.8189	-4.82	4.27
112	1.0344	0.9070	0.7943	-4.88	4.32
113	1.0053	0.8807	0.7706	-4.94	4.37
114	0.9771	0.8553	0.7478	-5.00	4.41
115	0.9499	0.8307	0.7256	-5.06	4.46
116	0.9235	0.8070	0.7043	-5.12	4.51
117	0.8980	0.7840	0.6837	-5.18	4.56
118	0.8734	0.7618	0.6637	-5.24	4.61
119	0.8495	0.7404	0.6445	-5.30	4.66
120	0.8263	0.7196	0.6258	-5.36	4.71

## Pipe Sensor

R25°C=10K $\Omega$   $\pm$ 3%B25°C/50°C=3700K $\pm$ 3%

Temp.((°C))	Max.(K $\Omega$ )	Normal(K $\Omega$ )	Min.(K $\Omega$ )	Tolerance(°C)	
-30	165.2170	147.9497	132.3678	-1.94	1.75
-29	155.5754	139.5600	125.0806	-1.93	1.74
-28	146.5609	131.7022	118.2434	-1.91	1.73
-27	138.1285	124.3392	111.8256	-1.89	1.71
-26	130.2371	117.4366	105.7989	-1.87	1.70
-25	122.8484	110.9627	100.1367	-1.85	1.69
-24	115.9272	104.8882	94.8149	-1.83	1.67
-23	109.4410	99.1858	89.8106	-1.81	1.66
-22	103.3598	93.8305	85.1031	-1.80	1.64
-21	97.6556	88.7989	80.6728	-1.78	1.63
-20	92.3028	84.0695	76.5017	-1.76	1.62
-19	87.2775	79.6222	72.5729	-1.74	1.60
-18	82.5577	75.4384	68.8710	-1.72	1.59
-17	78.1230	71.5010	65.3815	-1.70	1.57
-16	73.9543	67.7939	62.0907	-1.68	1.55
-15	70.0342	64.3023	58.9863	-1.66	1.54

-14	66.3463	61.0123	56.0565	-1.64	1.52
-13	62.8755	57.9110	53.2905	-1.62	1.51
-12	59.6076	54.9866	50.6781	-1.60	1.49
-11	56.5296	52.2278	48.2099	-1.58	1.47
-10	53.6294	49.6244	45.8771	-1.56	1.46
-9	50.8956	47.1666	43.6714	-1.54	1.44
-8	48.3178	44.8454	41.5851	-1.51	1.42
-7	45.8860	42.6525	39.6112	-1.49	1.40
-6	43.5912	40.5800	37.7429	-1.47	1.39
-5	41.4249	38.6207	35.9739	-1.45	1.37
-4	39.3792	36.7676	34.2983	-1.43	1.35
-3	37.4465	35.0144	32.7108	-1.41	1.33
-2	35.6202	33.3552	31.2062	-1.38	1.31
-1	33.8936	31.7844	29.7796	-1.36	1.29
0	32.2608	30.2968	28.4267	-1.34	1.28
1	30.7162	28.8875	27.1431	-1.32	1.26
2	29.2545	27.5519	25.9250	-1.29	1.24
3	27.8708	26.2858	24.7686	-1.27	1.22
4	26.5605	25.0851	23.6704	-1.25	1.20
5	25.3193	23.9462	22.6273	-1.23	1.18
6	24.1432	22.8656	21.6361	-1.20	1.16
7	23.0284	21.8398	20.6939	-1.18	1.14
8	21.9714	20.8659	19.7982	-1.15	1.12
9	20.9688	19.9409	18.9463	-1.13	1.09
10	20.0176	19.0621	18.1358	-1.11	1.07
11	19.1149	18.2270	17.3646	-1.08	1.05
12	18.2580	17.4331	16.6305	-1.06	1.03
13	17.4442	16.6782	15.9315	-1.03	1.01
14	16.6711	15.9601	15.2657	-1.01	0.99
15	15.9366	15.2770	14.6315	-0.98	0.96
16	15.2385	14.6268	14.0271	-0.96	0.94
17	14.5748	14.0079	13.4510	-0.93	0.92
18	13.9436	13.4185	12.9017	-0.91	0.90
19	13.3431	12.8572	12.3778	-0.88	0.87
20	12.7718	12.3223	11.8780	-0.86	0.85
21	12.2280	11.8126	11.4011	-0.83	0.83
22	11.7102	11.3267	10.9459	-0.81	0.80
23	11.2172	10.8634	10.5114	-0.78	0.78
24	10.7475	10.4216	10.0964	-0.75	0.75
25	10.3000	10.0000	9.7000	-0.75	0.75
26	9.8975	9.5974	9.2980	-0.76	0.76
27	9.5129	9.2132	8.9148	-0.80	0.80
28	9.1454	8.8465	8.5496	-0.84	0.83
29	8.7942	8.4964	8.2013	-0.87	0.86
30	8.4583	8.1621	7.8691	-0.91	0.90

31	8.1371	7.8428	7.5522	-0.95	0.93
32	7.8299	7.5377	7.2498	-0.98	0.97
33	7.5359	7.2461	6.9611	-1.02	1.00
34	7.2546	6.9673	6.6854	-1.06	1.04
35	6.9852	6.7008	6.4222	-1.10	1.07
36	6.7273	6.4459	6.1707	-1.13	1.11
37	6.4803	6.2021	5.9304	-1.17	1.14
38	6.2437	5.9687	5.7007	-1.21	1.18
39	6.0170	5.7454	5.4812	-1.25	1.22
40	5.7997	5.5316	5.2712	-1.29	1.25
41	5.5914	5.3269	5.0704	-1.33	1.29
42	5.3916	5.1308	4.8783	-1.37	1.33
43	5.2001	4.9430	4.6944	-1.41	1.36
44	5.0163	4.7630	4.5185	-1.45	1.40
45	4.8400	4.5905	4.3500	-1.49	1.44
46	4.6708	4.4252	4.1887	-1.53	1.47
47	4.5083	4.2666	4.0342	-1.57	1.51
48	4.3524	4.1145	3.8862	-1.61	1.55
49	4.2026	3.9686	3.7443	-1.65	1.59
50	4.0588	3.8287	3.6084	-1.70	1.62
51	3.9206	3.6943	3.4780	-1.74	1.66
52	3.7878	3.5654	3.3531	-1.78	1.70
53	3.6601	3.4416	3.2332	-1.82	1.74
54	3.5374	3.3227	3.1183	-1.87	1.78
55	3.4195	3.2085	3.0079	-1.91	1.82
56	3.3060	3.0989	2.9021	-1.95	1.85
57	3.1969	2.9935	2.8005	-2.00	1.89
58	3.0919	2.8922	2.7029	-2.04	1.93
59	2.9909	2.7948	2.6092	-2.08	1.97
60	2.8936	2.7012	2.5193	-2.13	2.01
61	2.8000	2.6112	2.4328	-2.17	2.05
62	2.7099	2.5246	2.3498	-2.22	2.09
63	2.6232	2.4413	2.2700	-2.26	2.13
64	2.5396	2.3611	2.1932	-2.31	2.17
65	2.4591	2.2840	2.1195	-2.36	2.21
66	2.3815	2.2098	2.0486	-2.40	2.25
67	2.3068	2.1383	1.9803	-2.45	2.29
68	2.2347	2.0695	1.9147	-2.49	2.34
69	2.1652	2.0032	1.8516	-2.54	2.38
70	2.0983	1.9393	1.7908	-2.59	2.42
71	2.0337	1.8778	1.7324	-2.63	2.46
72	1.9714	1.8186	1.6761	-2.68	2.50
73	1.9113	1.7614	1.6219	-2.73	2.54
74	1.8533	1.7064	1.5697	-2.78	2.58
75	1.7974	1.6533	1.5194	-2.83	2.63

76	1.7434	1.6021	1.4710	-2.88	2.67
77	1.6913	1.5528	1.4243	-2.92	2.71
78	1.6409	1.5051	1.3794	-2.97	2.75
79	1.5923	1.4592	1.3360	-3.02	2.80
80	1.5454	1.4149	1.2942	-3.07	2.84
81	1.5000	1.3721	1.2540	-3.12	2.88
82	1.4562	1.3308	1.2151	-3.17	2.93
83	1.4139	1.2910	1.1776	-3.22	2.97
84	1.3730	1.2525	1.1415	-3.27	3.01
85	1.3335	1.2153	1.1066	-3.32	3.06
86	1.2953	1.1794	1.0730	-3.38	3.10
87	1.2583	1.1448	1.0405	-3.43	3.15
88	1.2226	1.1113	1.0092	-3.48	3.19
89	1.1880	1.0789	0.9789	-3.53	3.24
90	1.1546	1.0476	0.9497	-3.58	3.28
91	1.1223	1.0174	0.9215	-3.64	3.33
92	1.0910	0.9882	0.8942	-3.69	3.37
93	1.0607	0.9599	0.8679	-3.74	3.42
94	1.0314	0.9326	0.8424	-3.80	3.46
95	1.0030	0.9061	0.8179	-3.85	3.51
96	0.9756	0.8806	0.7941	-3.90	3.55
97	0.9490	0.8558	0.7711	-3.96	3.60
98	0.9232	0.8319	0.7489	-4.01	3.64
99	0.8983	0.8088	0.7275	-4.07	3.69
100	0.8741	0.7863	0.7067	-4.12	3.74
101	0.8507	0.7646	0.6867	-4.18	3.78
102	0.8281	0.7436	0.6672	-4.23	3.83
103	0.8061	0.7233	0.6484	-4.29	3.88
104	0.7848	0.7036	0.6303	-4.34	3.92
105	0.7641	0.6845	0.6127	-4.40	3.97
106	0.7441	0.6661	0.5957	-4.46	4.02
107	0.7247	0.6482	0.5792	-4.51	4.07
108	0.7059	0.6308	0.5632	-4.57	4.12
109	0.6877	0.6140	0.5478	-4.63	4.16
110	0.6700	0.5977	0.5328	-4.69	4.21
111	0.6528	0.5820	0.5183	-4.74	4.26
112	0.6361	0.5667	0.5043	-4.80	4.31
113	0.6200	0.5518	0.4907	-4.86	4.36
114	0.6043	0.5374	0.4775	-4.92	4.41
115	0.5891	0.5235	0.4648	-4.98	4.45
116	0.5743	0.5100	0.4524	-5.04	4.50
117	0.5600	0.4968	0.4404	-5.10	4.55
118	0.5460	0.4841	0.4288	-5.16	4.60
119	0.5325	0.4717	0.4175	-5.22	4.65
120	0.5194	0.4597	0.4066	-5.28	4.70

## 5.4.2 Outdoor Unit

### Ambient Sensor, Suction Sensor, Defrosting Sensor

R25°C=10K $\Omega$   $\pm$ 3%

B25°C/50°C=3700K $\pm$ 3%

Temp.(°C)	Max.(K $\Omega$ )	Normal(K $\Omega$ )	Min.(K $\Omega$ )	Tolerance(°C)	
-30	165.2170	147.9497	132.3678	-1.94	1.75
-29	155.5754	139.5600	125.0806	-1.93	1.74
-28	146.5609	131.7022	118.2434	-1.91	1.73
-27	138.1285	124.3392	111.8256	-1.89	1.71
-26	130.2371	117.4366	105.7989	-1.87	1.70
-25	122.8484	110.9627	100.1367	-1.85	1.69
-24	115.9272	104.8882	94.8149	-1.83	1.67
-23	109.4410	99.1858	89.8106	-1.81	1.66
-22	103.3598	93.8305	85.1031	-1.80	1.64
-21	97.6556	88.7989	80.6728	-1.78	1.63
-20	92.3028	84.0695	76.5017	-1.76	1.62
-19	87.2775	79.6222	72.5729	-1.74	1.60
-18	82.5577	75.4384	68.8710	-1.72	1.59
-17	78.1230	71.5010	65.3815	-1.70	1.57
-16	73.9543	67.7939	62.0907	-1.68	1.55
-15	70.0342	64.3023	58.9863	-1.66	1.54
-14	66.3463	61.0123	56.0565	-1.64	1.52
-13	62.8755	57.9110	53.2905	-1.62	1.51
-12	59.6076	54.9866	50.6781	-1.60	1.49
-11	56.5296	52.2278	48.2099	-1.58	1.47
-10	53.6294	49.6244	45.8771	-1.56	1.46
-9	50.8956	47.1666	43.6714	-1.54	1.44
-8	48.3178	44.8454	41.5851	-1.51	1.42
-7	45.8860	42.6525	39.6112	-1.49	1.40
-6	43.5912	40.5800	37.7429	-1.47	1.39
-5	41.4249	38.6207	35.9739	-1.45	1.37
-4	39.3792	36.7676	34.2983	-1.43	1.35
-3	37.4465	35.0144	32.7108	-1.41	1.33
-2	35.6202	33.3552	31.2062	-1.38	1.31
-1	33.8936	31.7844	29.7796	-1.36	1.29
0	32.2608	30.2968	28.4267	-1.34	1.28
1	30.7162	28.8875	27.1431	-1.32	1.26
2	29.2545	27.5519	25.9250	-1.29	1.24
3	27.8708	26.2858	24.7686	-1.27	1.22
4	26.5605	25.0851	23.6704	-1.25	1.20
5	25.3193	23.9462	22.6273	-1.23	1.18
6	24.1432	22.8656	21.6361	-1.20	1.16
7	23.0284	21.8398	20.6939	-1.18	1.14
8	21.9714	20.8659	19.7982	-1.15	1.12
9	20.9688	19.9409	18.9463	-1.13	1.09

10	20.0176	19.0621	18.1358	-1.11	1.07
11	19.1149	18.2270	17.3646	-1.08	1.05
12	18.2580	17.4331	16.6305	-1.06	1.03
13	17.4442	16.6782	15.9315	-1.03	1.01
14	16.6711	15.9601	15.2657	-1.01	0.99
15	15.9366	15.2770	14.6315	-0.98	0.96
16	15.2385	14.6268	14.0271	-0.96	0.94
17	14.5748	14.0079	13.4510	-0.93	0.92
18	13.9436	13.4185	12.9017	-0.91	0.90
19	13.3431	12.8572	12.3778	-0.88	0.87
20	12.7718	12.3223	11.8780	-0.86	0.85
21	12.2280	11.8126	11.4011	-0.83	0.83
22	11.7102	11.3267	10.9459	-0.81	0.80
23	11.2172	10.8634	10.5114	-0.78	0.78
24	10.7475	10.4216	10.0964	-0.75	0.75
25	10.3000	10.0000	9.7000	-0.75	0.75
26	9.8975	9.5974	9.2980	-0.76	0.76
27	9.5129	9.2132	8.9148	-0.80	0.80
28	9.1454	8.8465	8.5496	-0.84	0.83
29	8.7942	8.4964	8.2013	-0.87	0.86
30	8.4583	8.1621	7.8691	-0.91	0.90
31	8.1371	7.8428	7.5522	-0.95	0.93
32	7.8299	7.5377	7.2498	-0.98	0.97
33	7.5359	7.2461	6.9611	-1.02	1.00
34	7.2546	6.9673	6.6854	-1.06	1.04
35	6.9852	6.7008	6.4222	-1.10	1.07
36	6.7273	6.4459	6.1707	-1.13	1.11
37	6.4803	6.2021	5.9304	-1.17	1.14
38	6.2437	5.9687	5.7007	-1.21	1.18
39	6.0170	5.7454	5.4812	-1.25	1.22
40	5.7997	5.5316	5.2712	-1.29	1.25
41	5.5914	5.3269	5.0704	-1.33	1.29
42	5.3916	5.1308	4.8783	-1.37	1.33
43	5.2001	4.9430	4.6944	-1.41	1.36
44	5.0163	4.7630	4.5185	-1.45	1.40
45	4.8400	4.5905	4.3500	-1.49	1.44
46	4.6708	4.4252	4.1887	-1.53	1.47
47	4.5083	4.2666	4.0342	-1.57	1.51
48	4.3524	4.1145	3.8862	-1.61	1.55
49	4.2026	3.9686	3.7443	-1.65	1.59
50	4.0588	3.8287	3.6084	-1.70	1.62
51	3.9206	3.6943	3.4780	-1.74	1.66
52	3.7878	3.5654	3.3531	-1.78	1.70
53	3.6601	3.4416	3.2332	-1.82	1.74
54	3.5374	3.3227	3.1183	-1.87	1.78



55	3.4195	3.2085	3.0079	-1.91	1.82
56	3.3060	3.0989	2.9021	-1.95	1.85
57	3.1969	2.9935	2.8005	-2.00	1.89
58	3.0919	2.8922	2.7029	-2.04	1.93
59	2.9909	2.7948	2.6092	-2.08	1.97
60	2.8936	2.7012	2.5193	-2.13	2.01
61	2.8000	2.6112	2.4328	-2.17	2.05
62	2.7099	2.5246	2.3498	-2.22	2.09
63	2.6232	2.4413	2.2700	-2.26	2.13
64	2.5396	2.3611	2.1932	-2.31	2.17
65	2.4591	2.2840	2.1195	-2.36	2.21
66	2.3815	2.2098	2.0486	-2.40	2.25
67	2.3068	2.1383	1.9803	-2.45	2.29
68	2.2347	2.0695	1.9147	-2.49	2.34
69	2.1652	2.0032	1.8516	-2.54	2.38
70	2.0983	1.9393	1.7908	-2.59	2.42
71	2.0337	1.8778	1.7324	-2.63	2.46
72	1.9714	1.8186	1.6761	-2.68	2.50
73	1.9113	1.7614	1.6219	-2.73	2.54
74	1.8533	1.7064	1.5697	-2.78	2.58
75	1.7974	1.6533	1.5194	-2.83	2.63
76	1.7434	1.6021	1.4710	-2.88	2.67
77	1.6913	1.5528	1.4243	-2.92	2.71
78	1.6409	1.5051	1.3794	-2.97	2.75
79	1.5923	1.4592	1.3360	-3.02	2.80
80	1.5454	1.4149	1.2942	-3.07	2.84
81	1.5000	1.3721	1.2540	-3.12	2.88
82	1.4562	1.3308	1.2151	-3.17	2.93
83	1.4139	1.2910	1.1776	-3.22	2.97
84	1.3730	1.2525	1.1415	-3.27	3.01
85	1.3335	1.2153	1.1066	-3.32	3.06
86	1.2953	1.1794	1.0730	-3.38	3.10
87	1.2583	1.1448	1.0405	-3.43	3.15
88	1.2226	1.1113	1.0092	-3.48	3.19
89	1.1880	1.0789	0.9789	-3.53	3.24
90	1.1546	1.0476	0.9497	-3.58	3.28
91	1.1223	1.0174	0.9215	-3.64	3.33
92	1.0910	0.9882	0.8942	-3.69	3.37
93	1.0607	0.9599	0.8679	-3.74	3.42
94	1.0314	0.9326	0.8424	-3.80	3.46
95	1.0030	0.9061	0.8179	-3.85	3.51
96	0.9756	0.8806	0.7941	-3.90	3.55
97	0.9490	0.8558	0.7711	-3.96	3.60
98	0.9232	0.8319	0.7489	-4.01	3.64
99	0.8983	0.8088	0.7275	-4.07	3.69

100	0.8741	0.7863	0.7067	-4.12	3.74
101	0.8507	0.7646	0.6867	-4.18	3.78
102	0.8281	0.7436	0.6672	-4.23	3.83
103	0.8061	0.7233	0.6484	-4.29	3.88
104	0.7848	0.7036	0.6303	-4.34	3.92
105	0.7641	0.6845	0.6127	-4.40	3.97
106	0.7441	0.6661	0.5957	-4.46	4.02
107	0.7247	0.6482	0.5792	-4.51	4.07
108	0.7059	0.6308	0.5632	-4.57	4.12
109	0.6877	0.6140	0.5478	-4.63	4.16
110	0.6700	0.5977	0.5328	-4.69	4.21
111	0.6528	0.5820	0.5183	-4.74	4.26
112	0.6361	0.5667	0.5043	-4.80	4.31
113	0.6200	0.5518	0.4907	-4.86	4.36
114	0.6043	0.5374	0.4775	-4.92	4.41
115	0.5891	0.5235	0.4648	-4.98	4.45
116	0.5743	0.5100	0.4524	-5.04	4.50
117	0.5600	0.4968	0.4404	-5.10	4.55
118	0.5460	0.4841	0.4288	-5.16	4.60
119	0.5325	0.4717	0.4175	-5.22	4.65
120	0.5194	0.4597	0.4066	-5.28	4.70

## Discharging Sensor

R80°C=50KΩ ± 3%

B25/80°C=4450K ± 3%

Temp.((°C))	Max.(KΩ)	Normal(KΩ)	Min.(KΩ)	Tolerance(°C)	
-30	14646.0505	12061.7438	9924.4999	-2.96	2.45
-29	13654.1707	11267.8730	9290.2526	-2.95	2.44
-28	12735.8378	10531.3695	8700.6388	-2.93	2.44
-27	11885.1336	9847.7240	8152.2338	-2.92	2.43
-26	11096.6531	9212.8101	7641.8972	-2.91	2.42
-25	10365.4565	8622.8491	7166.7474	-2.90	2.42
-24	9687.0270	8074.3787	6724.1389	-2.88	2.41
-23	9057.2314	7564.2244	6311.6413	-2.87	2.41
-22	8472.2852	7089.4741	5927.0206	-2.86	2.40
-21	7928.7217	6647.4547	5568.2222	-2.84	2.39
-20	7423.3626	6235.7109	5233.3554	-2.83	2.39
-19	6953.2930	5851.9864	4920.6791	-2.82	2.38
-18	6515.8375	5494.2064	4628.5894	-2.80	2.37
-17	6108.5393	5160.4621	4355.6078	-2.79	2.37
-16	5729.1413	4848.9963	4100.3708	-2.77	2.36
-15	5375.5683	4558.1906	3861.6201	-2.76	2.35
-14	5045.9114	4286.5535	3638.1938	-2.75	2.34
-13	4738.4141	4032.7098	3429.0191	-2.73	2.34
-12	4451.4586	3795.3910	3233.1039	-2.72	2.33
-11	4183.5548	3573.4260	3049.5312	-2.70	2.32
-10	3933.3289	3365.7336	2877.4527	-2.69	2.31
-9	3699.5139	3171.3148	2716.0828	-2.67	2.30
-8	3480.9407	2989.2460	2564.6945	-2.66	2.29
-7	3276.5302	2818.6731	2422.6139	-2.64	2.28
-6	3085.2854	2658.8058	2289.2164	-2.63	2.28
-5	2906.2851	2508.9126	2163.9230	-2.61	2.27
-4	2738.6777	2368.3158	2046.1961	-2.60	2.26
-3	2581.6752	2236.3876	1935.5371	-2.58	2.25
-2	2434.5487	2112.5459	1831.4826	-2.56	2.24
-1	2296.6230	1996.2509	1733.6024	-2.55	2.23
0	2167.2730	1887.0018	1641.4966	-2.53	2.22
1	2045.9191	1784.3336	1554.7931	-2.52	2.21
2	1932.0242	1687.8144	1473.1460	-2.50	2.20
3	1825.0899	1597.0431	1396.2333	-2.48	2.19
4	1724.6540	1511.6468	1323.7551	-2.47	2.17
5	1630.2870	1431.2787	1255.4324	-2.45	2.16
6	1541.5904	1355.6163	1191.0048	-2.43	2.15
7	1458.1938	1284.3593	1130.2298	-2.41	2.14
8	1379.7528	1217.2282	1072.8813	-2.40	2.13
9	1305.9472	1153.9626	1018.7481	-2.38	2.12
10	1236.4792	1094.3200	967.6334	-2.36	2.11

11	1171.0715	1038.0743	919.3533	-2.35	2.09
12	1109.4661	985.0146	873.7359	-2.33	2.08
13	1051.4226	934.9440	830.6210	-2.31	2.07
14	996.7169	887.6792	789.8583	-2.29	2.06
15	945.1404	843.0486	751.3077	-2.27	2.04
16	896.4981	800.8922	714.8380	-2.26	2.03
17	850.6086	761.0603	680.3265	-2.24	2.02
18	807.3024	723.4134	647.6580	-2.22	2.00
19	766.4212	687.8205	616.7252	-2.20	1.99
20	727.8172	654.1596	587.4271	-2.18	1.98
21	691.3524	622.3161	559.6694	-2.16	1.96
22	656.8979	592.1831	533.3634	-2.14	1.95
23	624.3328	563.6604	508.4261	-2.12	1.93
24	593.5446	536.6540	484.7796	-2.10	1.92
25	564.4275	511.0760	462.3510	-2.09	1.90
26	536.9865	486.9352	441.1516	-2.07	1.89
27	511.0105	464.0500	421.0258	-2.05	1.87
28	486.4151	442.3499	401.9146	-2.03	1.86
29	463.1208	421.7683	383.7626	-2.01	1.84
30	441.0535	402.2430	366.5175	-1.99	1.83
31	420.1431	383.7151	350.1301	-1.97	1.81
32	400.3242	366.1295	334.5542	-1.95	1.80
33	381.5350	349.4341	319.7460	-1.93	1.78
34	363.7176	333.5801	305.6645	-1.90	1.76
35	346.8176	318.5216	292.2709	-1.88	1.75
36	330.7839	304.2151	279.5286	-1.86	1.73
37	315.5682	290.6199	267.4031	-1.84	1.71
38	301.1254	277.6976	255.8620	-1.82	1.70
39	287.4128	265.4119	244.8745	-1.80	1.68
40	274.3905	253.7288	234.4118	-1.78	1.66
41	262.0206	242.6161	224.4465	-1.76	1.64
42	250.2676	232.0436	214.9529	-1.74	1.63
43	239.0983	221.9825	205.9065	-1.71	1.61
44	228.4809	212.4060	197.2844	-1.69	1.59
45	218.3860	203.2887	189.0648	-1.67	1.57
46	208.7855	194.6066	181.2273	-1.65	1.55
47	199.6531	186.3369	173.7524	-1.63	1.54
48	190.9639	178.4584	166.6217	-1.60	1.52
49	182.6945	170.9508	159.8181	-1.58	1.50
50	174.8228	163.7951	153.3249	-1.56	1.48
51	167.3280	156.9733	147.1268	-1.53	1.46
52	160.1904	150.4683	141.2090	-1.51	1.44
53	153.3914	144.2641	135.5577	-1.49	1.42
54	146.9136	138.3454	130.1598	-1.47	1.40
55	140.7403	132.6980	125.0027	-1.44	1.38

56	134.8559	127.3081	120.0746	-1.42	1.36
57	129.2457	122.1630	115.3645	-1.40	1.34
58	123.8956	117.2504	110.8618	-1.37	1.32
59	118.7926	112.5589	106.5564	-1.35	1.30
60	113.9241	108.0776	102.4388	-1.32	1.28
61	109.2784	103.7961	98.5000	-1.30	1.26
62	104.8443	99.7046	94.7315	-1.28	1.23
63	100.6112	95.7939	91.1253	-1.25	1.21
64	96.5692	92.0553	87.6735	-1.23	1.19
65	92.7088	88.4805	84.3690	-1.20	1.17
66	89.0211	85.0614	81.2048	-1.18	1.15
67	85.4976	81.7908	78.1744	-1.15	1.12
68	82.1303	78.6615	75.2715	-1.13	1.10
69	78.9116	75.6668	72.4902	-1.10	1.08
70	75.8343	72.8004	69.8249	-1.08	1.06
71	72.8916	70.0561	67.2703	-1.05	1.03
72	70.0770	67.4283	64.8213	-1.03	1.01
73	67.3844	64.9115	62.4731	-1.00	0.99
74	64.8080	62.5006	60.2211	-0.98	0.96
75	62.3423	60.1906	58.0609	-0.95	0.94
76	59.9821	57.9770	55.9885	-0.92	0.92
77	57.7223	55.8552	53.9998	-0.90	0.89
78	55.5583	53.8210	52.0912	-0.87	0.87
79	53.4856	51.8706	50.2591	-0.85	0.84
80	51.5000	50.0000	48.5000	-0.85	0.84
81	49.7063	48.2057	46.7083	-0.85	0.85
82	47.9835	46.4842	44.9911	-0.89	0.89
83	46.3286	44.8323	43.3452	-0.93	0.92
84	44.7385	43.2468	41.7672	-0.96	0.95
85	43.2105	41.7248	40.2540	-1.00	0.99
86	41.7386	40.2604	38.7996	-1.03	1.02
87	40.3241	38.8545	37.4048	-1.07	1.06
88	38.9643	37.5045	36.0668	-1.11	1.09
89	37.6569	36.2078	34.7831	-1.14	1.13
90	36.3996	34.9622	33.5513	-1.18	1.16
91	35.1903	33.7653	32.3689	-1.22	1.19
92	34.0269	32.6151	31.2338	-1.26	1.23
93	32.9075	31.5096	30.1438	-1.30	1.27
94	31.8302	30.4467	29.0970	-1.33	1.30
95	30.7933	29.4246	28.0915	-1.37	1.34
96	29.7950	28.4417	27.1254	-1.41	1.37
97	28.8337	27.4961	26.1970	-1.45	1.41
98	27.9078	26.5864	25.3048	-1.49	1.44
99	27.0160	25.7110	24.4470	-1.53	1.48
100	26.1569	24.8685	23.6222	-1.57	1.52

101	25.3290	24.0574	22.8291	-1.61	1.55
102	24.5311	23.2765	22.0662	-1.65	1.59
103	23.7620	22.5245	21.3323	-1.69	1.63
104	23.0205	21.8002	20.6261	-1.73	1.66
105	22.3055	21.1025	19.9465	-1.77	1.70
106	21.6159	20.4303	19.2924	-1.81	1.74
107	20.9508	19.7825	18.6626	-1.85	1.77
108	20.3091	19.1582	18.0563	-1.89	1.81
109	19.6899	18.5564	17.4723	-1.93	1.85
110	19.0924	17.9761	16.9098	-1.98	1.89
111	18.5157	17.4166	16.3680	-2.02	1.93
112	17.9590	16.8769	15.8458	-2.06	1.96
113	17.4214	16.3564	15.3427	-2.10	2.00
114	16.9023	15.8542	14.8577	-2.15	2.04
115	16.4010	15.3696	14.3902	-2.19	2.08
116	15.9167	14.9020	13.9394	-2.23	2.12
117	15.4489	14.4506	13.5047	-2.27	2.16
118	14.9968	14.0149	13.0855	-2.32	2.19
119	14.5599	13.5942	12.6811	-2.36	2.23
120	14.1376	13.1879	12.2909	-2.41	2.27
121	13.7294	12.7955	11.9144	-2.45	2.31
122	13.3347	12.4165	11.5510	-2.50	2.35
123	12.9531	12.0503	11.2003	-2.54	2.39
124	12.5840	11.6965	10.8617	-2.58	2.43
125	12.2270	11.3545	10.5348	-2.63	2.47
126	11.8817	11.0240	10.2191	-2.68	2.51
127	11.5475	10.7046	9.9142	-2.72	2.55
128	11.2242	10.3957	9.6197	-2.77	2.59
129	10.9112	10.0970	9.3352	-2.81	2.63
130	10.6084	9.8082	9.0602	-2.86	2.67
131	10.3151	9.5288	8.7945	-2.91	2.71
132	10.0312	9.2586	8.5378	-2.95	2.75
133	9.7563	8.9971	8.2895	-3.00	2.80
134	9.4901	8.7441	8.0495	-3.05	2.84
135	9.2322	8.4993	7.8175	-3.09	2.88
136	8.9824	8.2623	7.5931	-3.14	2.92
137	8.7404	8.0329	7.3760	-3.19	2.96
138	8.5059	7.8108	7.1660	-3.24	3.00
139	8.2787	7.5958	6.9629	-3.29	3.04
140	8.0584	7.3875	6.7664	-3.33	3.09

## 6. System Configuration

### 6.1 System Configuration

After the installation and test operation of the room air conditioner have been completed, it should be operated and handled as described below. Every user would like to know the correct method of operation of the room air conditioner, to check if it is capable of cooling (or heating) well, and to know a clever method of using it. In order to meet this expectation of the users, giving sufficient explanations taking enough time can be said to reduce about 80% of the requests for servicing. However good the installation work is and however good the functions are, the customer may blame either the room air conditioner or its installation work because of improper handling. The installation work and handing over of the unit can only be considered to have been completed when its handling has been explained to the user without using technical terms but giving full knowledge of the equipment.

### 6.2 Instruction

# Parts and Functions

## Indoor Unit

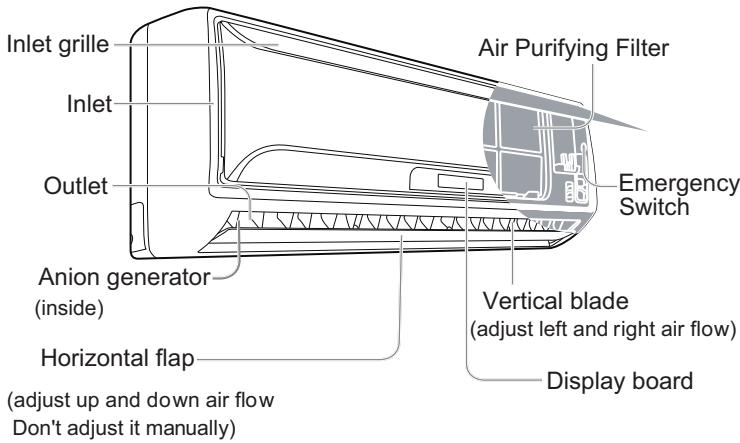

Actual inlet grille may vary from the one shown in the manual according to the product purchased

### Display board for 12:

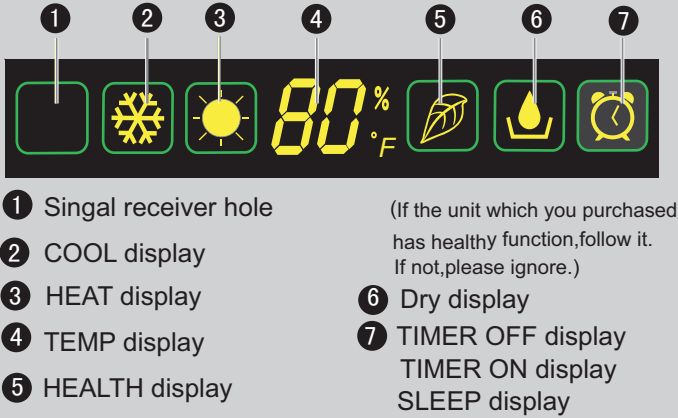

### Display board for 18:

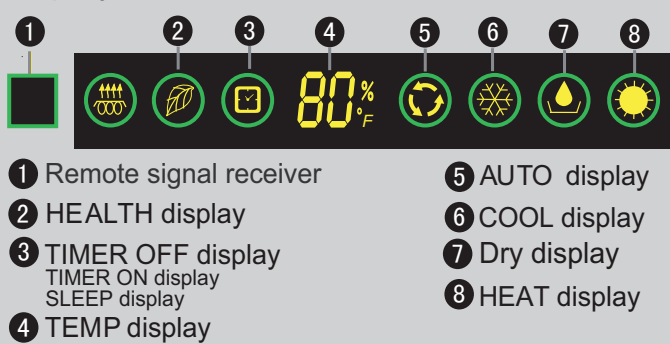

## Outdoor Unit

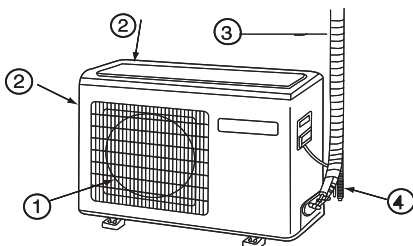

## Remote controller

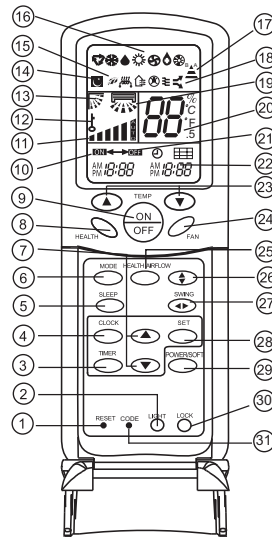

1. RESET button  
When the remote controller appears abnormal, use a sharp pointed article to press this button to reset the remote controller normal.
2. LIGHT button  
Control the lightening and extinguishing of the indoor LED display board.
3. TIMER button
4. CLOCK button
5. SLEEP button
6. MODE button
7. HOUR button
8. HEALTH button
9. ON/OFF button
10. TIMER ON display
11. FAN SPEED display
12. LOCK display
13. SWING UP/DOWN display
14. SLEEP display
15. HEALTH display
16. Operation mode display
17. Singal sending display
18. POWER/SOFT display
19. Left/right air flow display
20. TEMP display
21. TIMER OFF display
22. TIMER display
23. TEMP button
24. FAN button
25. HEALTH AIRFLOW button
26. SWING UP/DOWN button
27. SWING LEFT/RIGHT button
28. SET button
29. POWER/SOFT button
30. LOCK button  
If pressed, the other buttons will be disabled. Press it once again, lock will be cancelled.
31. CODE button  
Use to select CODE A or B which will be displayed on LCD. Please select A without special explanation.



Operation mode	AUTO	COOL	DRY	HEAT	FAN
Remote controller					

NOTE:  
Cooling only unit do not have functions and displays related with heating.

## Loading of the battery

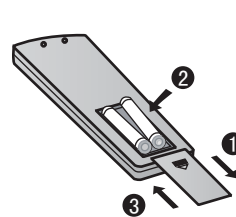

- 1 Remove the battery cover;
- 2 Load the batteries as illustrated. 2 R-03 batteries, resetting key (cylinder);
- 3 Be sure that the loading is in line with the "+" and "-";
- 4 Load the battery, then put on the cover again.

- Note:
- The distance between the signal transmission head and the receiver hole should be within 7m without any obstacle as well.
  - When electronic-started type fluorescent lamp or change-over type fluorescent lamp or wireless telephone is installed in the room, the receiver is apt to be disturbed in receiving the signals, so the distance to the indoor unit should be shorter.
  - Full display or unclear display during operation indicates the batteries have been used up. Please change batteries.
  - If the remote controller can't run normally during operation, please remove the batteries and reload several minutes later.

Hint:  
Remove the batteries in case unit won't be in usage for a long period. If there are any display after taking-out, just need to press reset key.



# Operation

## Clock set

Press CLOCK button, "AM" or "PM" flashes.  
 Press  $\Delta$  or  $\nabla$  to set correct time. Each press will increase or decrease 1min. If the button is kept pressed, time will change quickly. After time setting is confirmed, press SET, "AM" and "PM" stop flashing, while clock starts working.



## Base Operation

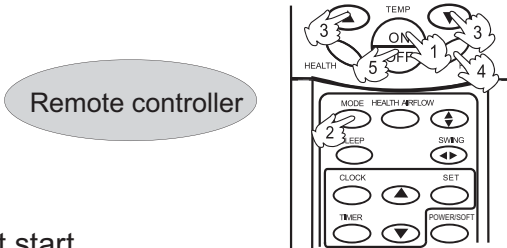

### 1. Unit start

Press ON/OFF on the remote controller, unit starts.

### 2. Select operation mode

Press MODE button. For each press, operation mode changes as follows:  
 Remote controller:



### 3. Select temp. setting

Press  $\Delta$  /  $\nabla$  button

- $\Delta$  Every time the button is pressed, temp. setting increase 2°F, if kept depressed, it will increase rapidly
- $\nabla$  Every time the button is pressed, temp. setting decrease 2°F, if kept depressed, it will decrease rapidly

Select a desired temperature.

### 4. Fan speed selection

Press FAN button. For each press, fan speed changes as follows:

Remote controller:



Air conditioner is running under displayed fan speed.  
 When FAN is set to AUTO, the air conditioner automatically adjusts the fan speed according to room temperature.

Operation Mode	Display Board	Remote Controller	Note
AUTO	For 12:		Under the mode of auto operation, air conditioner will automatically select Cool or Heat operation according to room temperature. When FAN is set to AUTO, the air conditioner automatically adjusts the fan speed according to room temperature.
	For 18:		
COOL	For 12:		
	For 18:		
DRY	For 12:		In DRY mode, when room temperature becomes lower than temp. setting about +35°F, unit will run intermittently at LOW speed regardless of FAN setting.
	For 18:		
HEAT	For 12:		
	For 18:		
FAN	nothing		In FAN operation mode, the unit will not operate in COOL or HEAT mode but only in FAN mode. AUTO is not available in FAN mode. And temp. setting is disabled. In FAN mode, SLEEP operation is not available.

## Emergency operation and test operation

### Emergency Operation:

Use this operation only when the remote controller is defective or lost.

### When the emergency operation switch is pressed, the "Pi" sound is heard once, which means the start of this operation.

- In this operation, the system automatically selects the operation modes, cooling or fan or heat, according to the room temperature.
- When machine is running in emergency, the set value of temperature and wind speed couldn't be altered; meanwhile, it can't operate for dehumidifying or under timing mode.

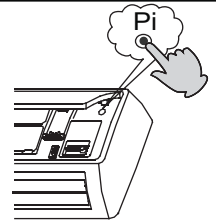

### Test operation:

Test operation switch is the same as emergency switch.

- Use this switch in the test operation when the room temperature is below 60°F, do not use it in the normal operation.

- Continue to press the test operation switch for more than 5 seconds. After you hear the "Pi" sound twice, release your finger from the switch: the cooling operation starts with the air flow speed "Hi".

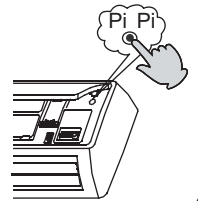

## Air Flow D...

### 1. Status display of air sending

Vertical flap

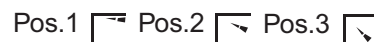

### 2. Left and right air flow adjustment (manual)

Move the vertical blade by a knob on air conditioner to adjust left and right direction referring to Fig.

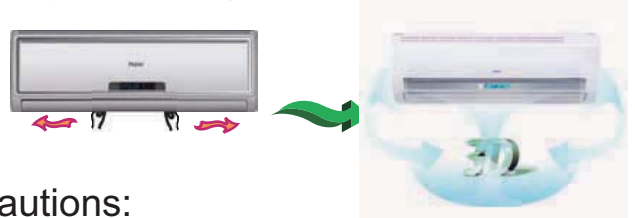

### Cautions:

- When adjusting the flap by hand, turn off the unit.
- When humidity is high, condensate water might occur at air outlet if all vertical louvers are adjusted to left or right.
- It is advisable not to keep horizontal flap at downward position for a long time in COOL or DRY mode, otherwise, condensate water might occur.

### Note:

When restart after remote turning off, the remote controller will automatically memorize the previous set swing position.

# Operation

## Sleep Operation

Before going to bed, you can simply press the SLEEP button and unit will operate in SLEEP mode and bring you a sound sleep.



### Use of SLEEP function

After the unit starts, set the operation status, then press SLEEP button before which the clock must be adjusted and time being set.

### Operation Mode

#### 1. In COOL, DRY mode

1 hours after SLEEP mode starts, temp. will become about 2°F higher than temp. setting. After another 1 hours, temp. rises about 2°F further. The unit will run for further 6 hours then stops. Temp. is higher than temp. setting so that room temperature won't be too low for your sleep.

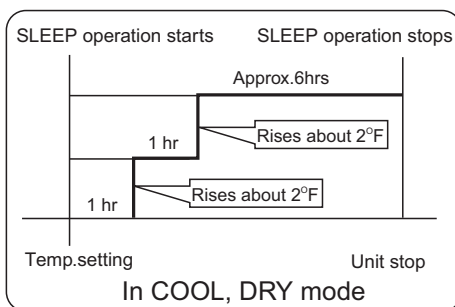

#### 2. In HEAT mode

1 hours after SLEEP mode starts, temp will become about 4°F lower than temp. setting. After another 1 hours, temp decrease about 4°F further. After more another 3 hours, temp. rises about 2°F further. The unit will run for further 3 hours then stops. Temp. is lower than temp. setting so that room temperature won't be too high for your sleep.

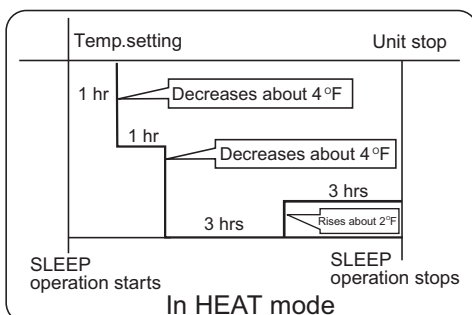

#### 3. In AUTO mode

The unit operates in corresponding sleep mode adapted to the automatically selected operation mode.

#### 4. In FAN mode

It has no SLEEP function.

#### 5. Set the wind speed change when sleeping

If the wind speed is high or middle before setting for the sleep, set for lowering the wind speed after sleeping.

If it is low wind, no change.

#### 6. Note to the power failure resume:

press the sleep button ten times in five seconds and enter this function after hearing four sounds. And press the sleep button ten times within five seconds and leave this function after hearing two sounds.

#### NOTE:

With the power failure resume, when setting the TIMER ON, TIMER OFF and TIMER ON/OFF, it's memorized as shutdown status when resuming after power out.

## POWER/SOFT Operation

### (1) POWER Operation

When you need rapid heating or cooling, you can use this function. In COOL mode, fan speed automatically takes high speed of AUTO fan mode. In HEAT mode, fan speed automatically takes medial speed of AUTO fan mode.

### (2) SOFT Operation

You can use this function when silence is needed for rest or reading. In SOFT operation mode, fan speed automatically takes low speed of AUTO fan mode.

#### Note:

During POWER operation, in rapid HEAT or COOL mode, the room will show inhomogeneous temperature distribution. Long period SOFT operation will cause effect of not too cool or not too warm.

To cancel POWER or SOFT operation

Press POWER/SOFT button again, POWER or SOFT disappears.

## HEALTH Operation



### Healthy Negative ion

The anion generator in the airconditioner can generate a lot of anion effectively balance the quantity of position and anion in the air and also to kill bacteria and speed up the dust sediment in the room and finally clean the air in the room.

# Operation

## Timer On/Off On-Off Operation

Set clock correctly before starting TIMER operation.

1. After unit starts, select your desired operation mode.
2. Press TIMER button to change TIMER mode. Every time the button is pressed, display changes as follows:  
Remote controller:



Then select your desired TIMER mode (TIMER ON or TIMER OFF or TIMER ON-OFF). "ON" or "OFF" will flash.

3. Press HOUR  $\blacktriangle$  /  $\blacktriangledown$  button to set time. It can be adjusted within 24 hours.
4. After setting correct time, press SET button to confirm "ON" or "OFF" on the remote controller stops flashing.
5. Cancel TIMER mode  
Just press TIMER button several times until TIMER mode disappears.

Hints:

After replacing batteries or a power failure happens, time setting should be reset.

Remote controller possesses memory function, when use TIMER mode next time, just press SET button after mode selecting if time setting is the same as previous one.

According to the Time setting sequence of TIMER ON or TIMER OFF, either Start-Stop or Stop-Start can be achieved.

## Health airflow Operation

1. Press ON/OFF to starting

Setting the comfort work conditions.

2. The setting of health airflow function

1). Press the button of health airflow,  $\text{☰}$  appears on the display. Horizontal airflow sending. Avoid the strong airflow blows direct to the body.

2). Press the button of health airflow again,  $\text{☷}$  appears on the display. Downward airflow sending. Avoid the strong airflow blows direct to the body.

3. The cancel of the health airflow function

Press the button of health airflow again, the unit goes on working under the condition before the setting of health airflow function.

Notice: Cannot pull direct the flap by hand. Otherwise, the grille will run incorrectly. If the grille is not run correctly, stop for a minute and then start, adjusting by remote controller.

Note:

1. After setting the health airflow function, the position grill is fixed.
2. In heating, it is better to select the  $\text{☷}$  mode.
3. In cooling, it is better to select the  $\text{☰}$  mode.
4. In cooling and dry, using the air conditioner for a long time under the high air humidity, a phenomenon falling drips of water occurs at the grille.

## IMPORTANT INFORMATION REGARDING THE REFRIGERANT USED

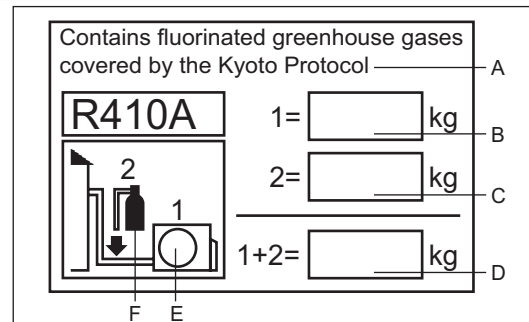

This product contains fluorinated greenhouse gases covered by the Kyoto Protocol. Do not vent into the atmosphere.

Refrigerant type: R410A

GWP\* value: 1975

GWP=global warming potential

Please fill in with indelible ink,

- 1 the factory refrigerant charge of the product
- 2 the additional refrigerant amount charged in the field and
- 1+2 the total refrigerant charge

on the refrigerant charge label supplied with the product.

The filled out label must be adhered in the proximity of the product charging port (e.g. onto the inside of the stop value cover).

A contains fluorinated greenhouse gases covered by the Kyoto Protocol

B factory refrigerant charge of the product: see unit name plate

C additional refrigerant amount charged in the field







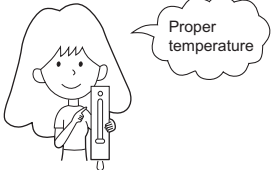
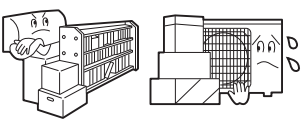

D total refrigerant charge

E outdoor unit

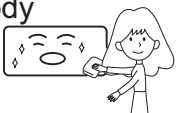
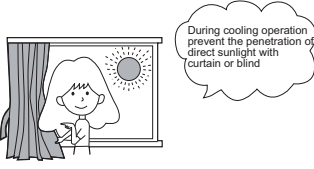
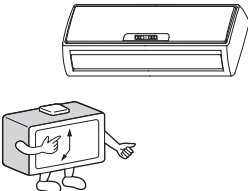

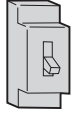
F refrigerant cylinder and manifold for charging

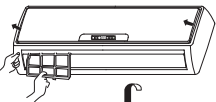
# Maintenance

## For Smart Use of The Air Conditioner

<p><b>Setting of proper room temperature</b></p> 	<p><b>Do not block the air inlet or outlet</b></p> 	<p><b>Remote Controller</b></p>  <p>Do not use water, wipe the controller with a dry cloth. Do not use glass cleaner or chemical cloth.</p>	<p><b>Indoor Body</b></p>  <p>Wipe the air conditioner by using a soft and dry cloth. For serious stains, use a neutral detergent diluted with water. Wring the water out of the cloth before wiping, then wipe off the detergent completely.</p>
<p><b>Close doors and windows during operation</b></p> 	<p><b>Use the timer effectively</b></p> 	<p><b>Do not use the following for cleaning</b></p>  <p>Gasoline, benzene, thinner or cleanser may damage the coating of the unit.</p>  <p>Hot water over 40°C (104°F) may cause discoloring or deformation.</p>	
<p><b>If the unit is not to be used for a long time, turn off the power supply main switch.</b></p> 	<p><b>Use the louvers effectively</b></p> 	<p><b>Air Filter cleaning</b></p> <ol style="list-style-type: none"> <li><b>1 Open the inlet grille by pulling it upward.</b></li> <li><b>2 Remove the filter.</b> Push up the filter's center tab slightly until it is released from the stopper, and remove the filter downward.</li> <li><b>3 Clean the filter.</b> Use a vacuum cleaner to remove dust, or wash the filter with water. After washing, dry the filter completely in the shade.</li> <li><b>4 Attach the filter.</b> Attach the filter correctly so that the "FRONT" indication is facing to the front. Make sure that the filter is completely fixed behind the stopper. If the right and left filters are not attached correctly, that may cause defects.</li> <li><b>5 Close the inlet grille.</b></li> </ol>  	

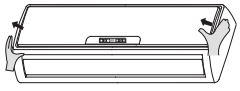
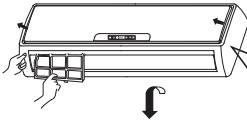
## Replacement of Air Purifying Filter

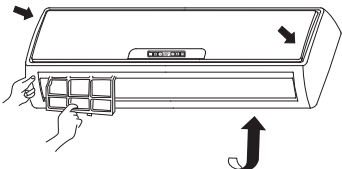
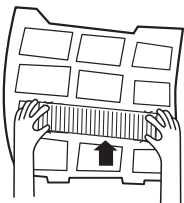
<p><b>1. Open the Inlet Grille</b> Prop up the inlet grille by using a small device named grille-support which located in the right side of the indoor unit.</p>  <p><b>2. Detach the standard air filter</b> Slide the knob slightly upward to release the filter, then withdraw it.</p>  <p>Detach old Air Purifying Filter</p> 	<p><b>4. Attach the standard air filter</b> (Necessary installation)</p>  <p><b>ATTENTION:</b> The white side of the photocatalyst air purifying filter face outside, and the black side face the unit. The green side of the bacteria-killing medium air purifying filter face outside, and the white side face the unit.</p> <p><b>5. Close the Inlet Grille</b> Close the Grille surely</p>
<p><b>3. Attach Air Purifying Filter</b> Put air purifying filter appliances into the right and left filter frames.</p> 	<p><b>NOTE:</b></p> <ul style="list-style-type: none"> <li>The photocatalyst air purifying filter will be solarized in fixed time. In normal family, it will be solarized every 6 months.</li> <li>The bacteria-killing medium air purifying filter will be used for a long time, no need for replacement. But in the period of using them, you should remove the dust frequently by using vacuum cleaner or flapping them lightly, otherwise, its performance will be affected.</li> <li>Please keep the bacteria-killing medium air purifying filter in the cool and dry conditions avoid long time directly sunshine when you stop using it, or its ability of sterilization will be reduced.</li> </ul>

# Cautions

## ⚠ WARNING

Please call Sales/Service Shop for the Installation.

Do not attempt to install the air conditioner by yourself because improper works may cause electric shock, fire, water leakage.

## ⚠ WARNING

When abnormality such as burnt-smell found, immediately stop the operation button and contact sales shop.



OFF



⚠  
STRICT  
ENFORCEMENT

Use an exclusive power source with a circuit breaker

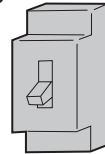

Check proper installation of the drainage securely



STRICT  
ENFORCEMENT

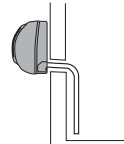

Connect power supply cord to the outlet completely



STRICT  
ENFORCEMENT

Use the proper voltage



STRICT  
ENFORCEMENT

1. Do not use power supply cord extended or connected in halfway  
2. Do not install in the place where there is any possibility of inflammable gas leakage around the unit.  
3. Do not get the unit exposed to vapor or oil steam.



PROHIBITION

Do not use power supply cord in a bundle.

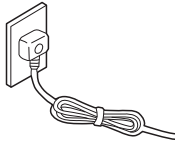

PROHIBITION

Take care not to damage the power supply cord.

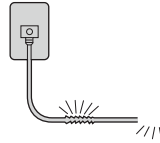

PROHIBITION

Do not insert objects into the air inlet or outlet.

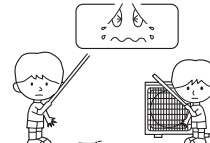

PROHIBITION

Do not start or stop the operation by disconnecting the power supply cord and so on.



PROHIBITION

Do not channel the air flow directly at people, especially at infants or the aged.



PROHIBITION

Do not try to repair or reconstruct by yourself.

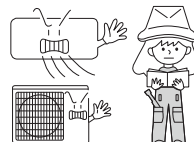

Connect the earth cable.

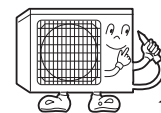

earthing

## ⚠ CAUTION

Do not use for the purpose of storage of food, art work, precise equipment, breeding, or cultivation.



PROHIBITION

Take fresh air occasionally especially when gas appliance is running at the same time.

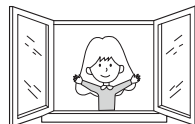

STRICT  
ENFORCEMENT

Do not operate the switch with wet hand.

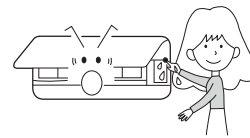

PROHIBITION

Do not install the unit near a fireplace or other heating apparatus.

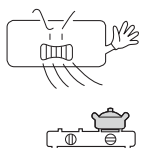

PROHIBITION

Check good condition of the installation stand

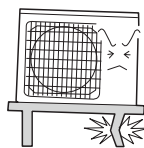

PROHIBITION

Do not pour water onto the unit for cleaning

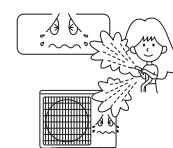

PROHIBITION

Do not place animals or plants in the direct path of the air flow

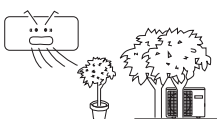

PROHIBITION

Do not place any objects on or climb on the unit.



PROHIBITION





Do not place flower vase or water containers on the top of the unit.



PROHIBITION

# Trouble shooting

Before asking for service, check the following first.

	Phenomenon	Cause or check points
Normal Performance inspection	The system does not restart immediately. 	<ul style="list-style-type: none"> <li>When unit is stopped, it won't restart immediately until 3 minutes have elapsed to protect the system.</li> <li>When the electric plug is pulled out and reinserted, the protection circuit will work for 3 minutes to protect the air conditioner.</li> </ul>
	Noise is heard 	<ul style="list-style-type: none"> <li>During unit operation or at stop, a swishing or gurgling noise may be heard. At first 2-3 minutes after unit start, this noise is more noticeable. (This noise is generated by refrigerant flowing in the system.)</li> <li>During unit operation, a cracking noise may be heard. This noise is generated by the casing expanding or shrinking because of temperature changes.</li> <li>Should there be a big noise from air flow in unit operation, air filter may be too dirty.</li> </ul>
	Smells are generated.	<ul style="list-style-type: none"> <li>This is because the system circulates smells from the interior air such as the smell of furniture, paint, cigarettes.</li> </ul>
	Mist or steam are blown out. 	<ul style="list-style-type: none"> <li>During COOL or DRY operation, indoor unit may blow out mist. This is due to the sudden cooling of indoor air.</li> </ul>
	In dry mode, fan speed can't be changed.	<ul style="list-style-type: none"> <li>In DRY mode, when room temperature becomes lower than temp. setting+3.6°F, unit will run intermittently at LOW speed regardless of FAN setting.</li> </ul>
Multiple check		<ul style="list-style-type: none"> <li>Is power plug inserted?</li> <li>Is there a power failure?</li> <li>Is fuse blownout?</li> </ul>
	Poor cooling 	<ul style="list-style-type: none"> <li>Is the air filter dirty? Normally it should be cleaned every 15 days.</li> <li>Are there any obstacles before inlet and outlet?</li> <li>Is temperature set correctly?</li> <li>Are there some doors or windows left open?</li> <li>Is there any direct sunlight through the window during the cooling operation?(Use curtain)</li> <li>Are there too much heat sources or too many people in the room during cooling operation?</li> </ul>

# Cautions

- Do not obstruct or cover the ventilation grille of the air conditioner. Do not put fingers or any other things into the inlet/outlet and swing louver.
- Do not allow children to play with the air conditioner. In no case should children be allowed to sit on the outdoor unit.

## Specifications

- The refrigerating circuit is leak-proof.

The machine is adaptive in following situation

1. Applicable ambient temperature range:

Cooling	Indoor	Maximum: D.B/W.B 32°C/23°C Minimum: D.B/W.B 21°C/15°C
	Outdoor	Maximum: D.B/W.B 43°C/26°C Minimum: D.B 18°C
Heating	Indoor	Maximum: D.B 27°C Minimum: D.B 0°C
	Outdoor	Maximum: D.B/W.B 24°C/18°C Minimum: D.B/W.B -7°C/-8°C
	Outdoor (INVERTER)	Maximum: D.B/W.B 24°C/18°C Minimum: D.B -15°C

- If the power supply cord is damaged, it must be replaced by the manufacturer or its service agent or a similar qualified person.
- If the fuse of indoor unit on PC board is broken, please change it with the type of T. 3.15A/ 250V. If the fuse of outdoor unit is broken, change it with the type of T.25A/250V
- The wiring method should be in line with the local wiring standard.
- After installation, the power plug should be easily reached.
- The waste battery should be disposed properly.
- The appliance is not intended for use by young children or infirm persons without supervision.
- Young children should be supervised to ensure that they do not play with the appliance.
- Please employ the proper power plug, which fit into the power supply cord.
- A breaker should be incorporated into fixed wiring. The breaker should be all-pole switch and the distance between its two contacts should be not less than 3mm.
- The power plug and connecting cable must have acquired the local attestation.
- In order to protect the units, please turn off the A/C first, and at least 30 seconds later, cutting off the power.

## 7 Service Diagnosis

### 7.1 Caution for Diagnosis

The operation lamp flashes when any of the following errors is detected.

1. When a protection device of the indoor or outdoor unit is activated or when the thermistor malfunctions, disabling equipment operation.
2. When a signal transmission error occurs between the indoor and outdoor units. In either case, conduct the diagnostic procedure described in the following pages.

### 7.2. Problem Symptoms and Measures

Symptom	Check Item	Details of Measure
None of the units operates	Check the power supply.	Check to make sure that the rated voltage is supplied.
	Check the indoor PCB	Check to make sure that the indoor PCB is broken
Operation sometimes stops.	Check the power supply.	A power failure of 2 to 10 cycles can stop air conditioner operation.
Equipment operates but does not cool, or does not heat (only for heat pump)	Check for faulty operation of the electronic expansion valve.	Set the units to cooling operation, and compare the temperatures of the liquid side connection pipes of the connection section among rooms to check the opening and closing operation of the electronic expansion valves of the individual units.
	Diagnosis by service port pressure and operating current.	Check for insufficient gas.
Large operating noise and vibrations	Check the installation condition.	Check to make sure that the required spaces for installation (specified in the Technical Guide, etc.) are provided.

### 7.3.Error Codes and Description indoor display

	Code indication		Description	Reference Page
	indoor	Outdoor (LED1 flash times)		
Indoorand Outdoor	E7	15	Communication fault between indoor and outdoor units	Page .78
Indoor Malfunction	E1		Room temperature sensor failure	Page .69
	E2		Heat-exchange sensor failure	Page .69
	E4		Indoor EEPROM error	Page .77
	E14		Indoor fan motor malfunction	Page .70
Outdoor Malfunction		1	Outdoor EEPROM error	Page .77
		2	The protection of IPM	Page .72
		3	Overcurrent protection of AC electricity for the outdoor model	
		4	Communication fault between the IPM and outdoor PCB	Page 73
		6	Power voltage is too high or low	Page .81
		8	Overheat protection for exhaust temperature	Page .75
		9	outdoor fan motor malfunction	
		10	Frost-removing temperature sensor failure	Page .74
		11	SUCK temperature sensor failure	Page .74
		12	Ambient temperature sensor failure	Page .74
		13	Exhaust temperature sensor failure	Page .74
		18	deviate from the normal for the compressor	Page .82
		19	Loop of the station detect error	Page .82
		24	Overcurrent of the compressor	Page .83
	25	Overcurrent protection for single-phase of the compressor	Page .83	



### 7.3.1 Thermistor or Related Abnormality (indoor unit)

<b>Indoor Display</b>	<b>E1:</b> Room temperature sensor failure <b>E2:</b> Heat-exchange sensor failure
<b>Method of Malfunction Detection</b>	the temperatures detected by the thermistors are used to determine thermistor errors
<b>Malfunction Decision Conditions</b>	when the thermistor input is more than 4.92V or less than 0.08V during compressor operation.
<b>Supposed Causes</b>	* <b>Note:</b> The values vary slightly in some models <ul style="list-style-type: none"> <li>■ Faulty connector connection</li> <li>■ Faulty thermistor</li> <li>■ Faulty PCB</li> </ul>
<b>Troubleshooting</b>	* <b>Caution</b> Be sure to turn off power switch before connect or disconnect connector, or else parts damage may be occurred.

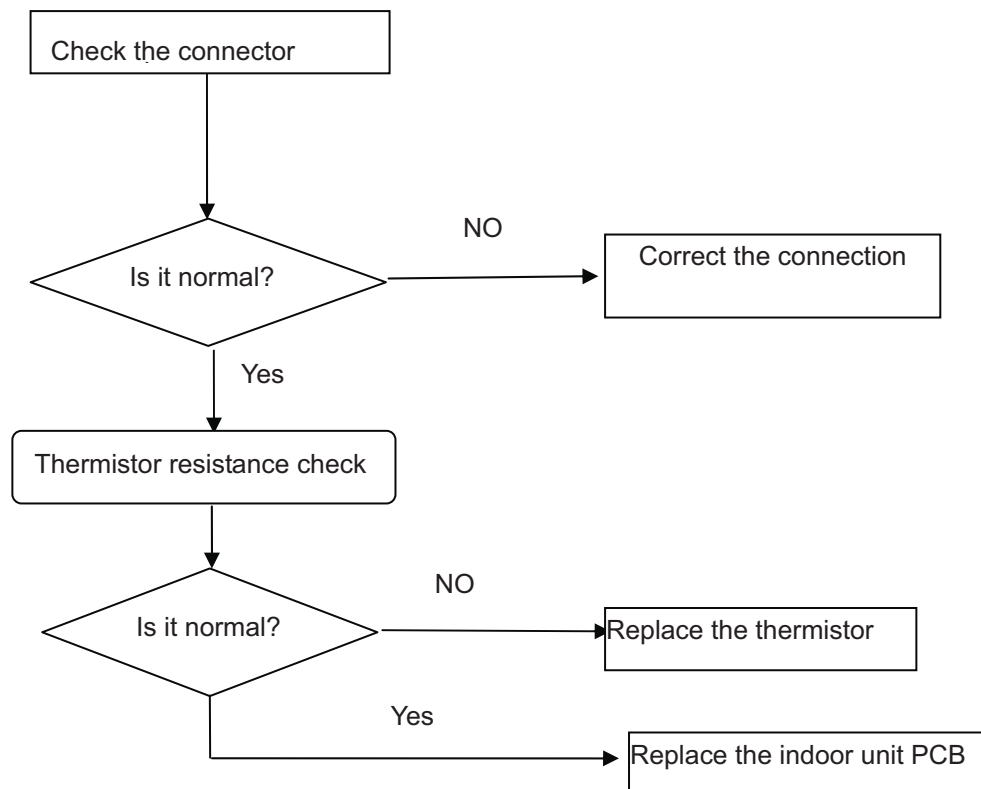

#### Thermistor resistance check method:

Remove the connector of the thermistor on the PCB, and measure the resistance of thermistor using tester. The relationship between normal temperature and resistance is shown in the value of indoor thermistor.

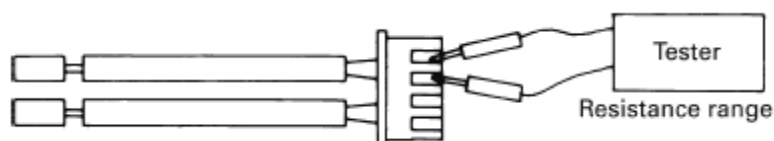

## 7.3.2 Indoor fan motor malfunction

Indoor display	<b>E14</b>
Method of Malfunction Detection	The rotation speed detected by the Hall IC during fan motor operation is used to determine abnormal fan motor operation
Malfunction Decision Conditions	when the detected rotation feedback signal don't received in 2 minutes
Supports causes	<ul style="list-style-type: none"> <li>■ Operation halt due to breaking of wire inside the fan motor .</li> <li>■ Operation halt due to breaking of the fan motor lead wires</li> <li>■ Detection error due to faulty indoor unit PCB</li> </ul>

### How to check Fan Motor (DC)

1. Check connector connection.
2. Check motor power supply voltage output (pins 1-4).
3. Check motor control voltage (pins 4-5).
4. Check rotation command voltage output (pins 4-6).
5. Check rotation pulse input (pins 4-7).

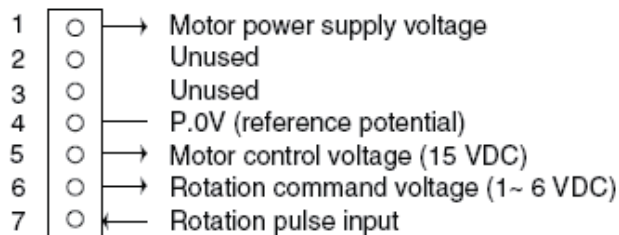

Notes:the a/c is electrifying,don't pull out or insert the terminals of the motor,else the motor would be damaged

**Troubleshooting** \* **Caution** Be sure to turn off power switch before connect or disconnect connector, or else parts damage may be occurred.

Turn off power supply and rotate fan by hand

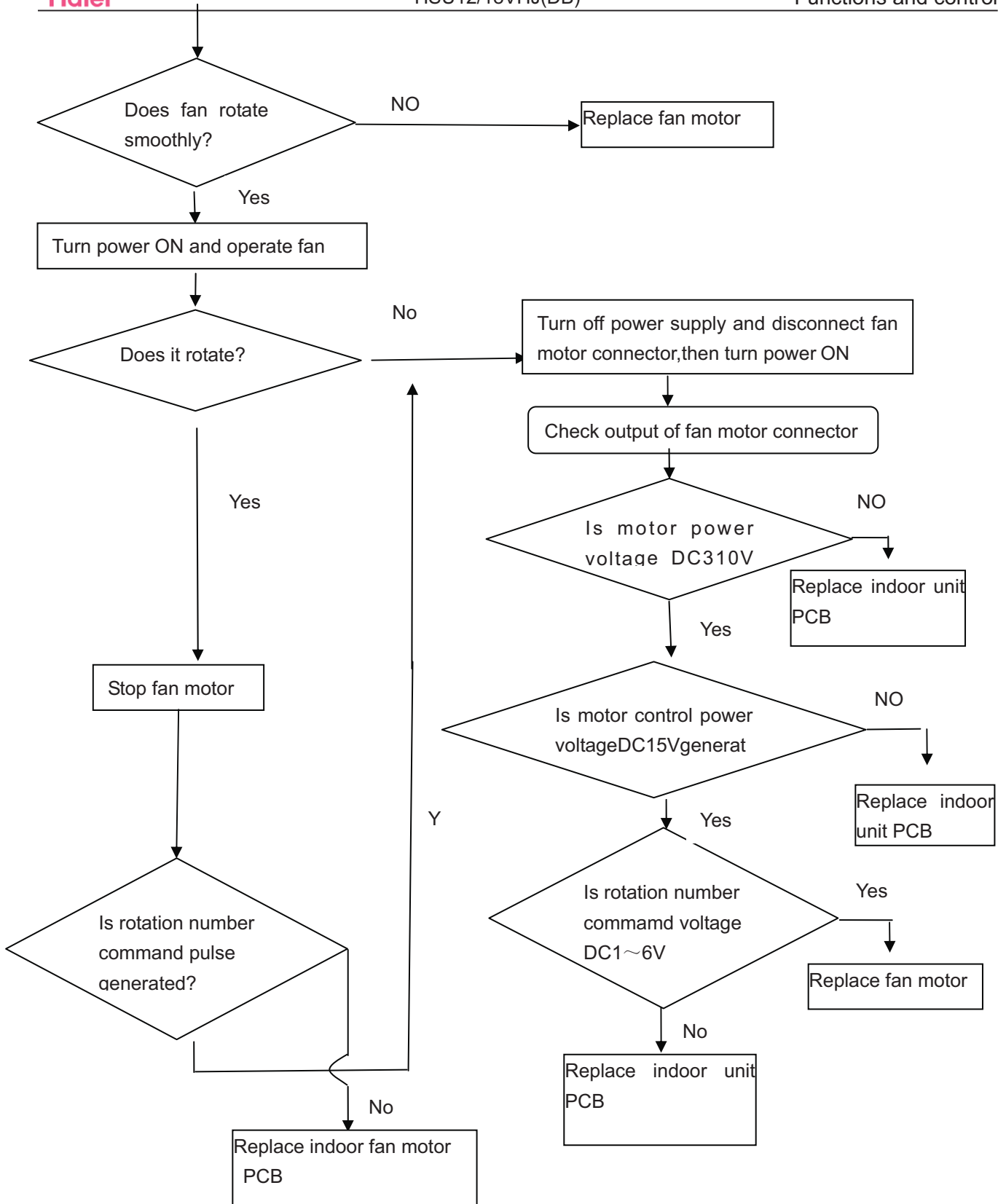

### 7.3.3 IPM protection

<b>outdoor display</b>	LED1 flash 2 times: <b>Indoor Display F1</b>
<b>Method of Malfunction Detection</b>	IPM protection is detected by checking the compressor running condition and so on.
<b>Malfunction Decision Conditions</b>	<ul style="list-style-type: none"> <li>■ The system leads to IPM protection due to over current</li> <li>■ The compressor faulty leads to IPM protection</li> <li>■ circuit component of IPM is broken and led to IPM protection</li> </ul>
<b>Supposed Causes</b>	<ul style="list-style-type: none"> <li>■ IPM protection dues to the compressor faulty</li> <li>■ IPM protection dues to faulty PCB of IPM module</li> <li>■ Compressor wiring disconnected</li> </ul>

**Troubleshooting** \* **Caution** Be sure to turn off power switch before connect or disconnect connector, or else parts damage may be occurred.

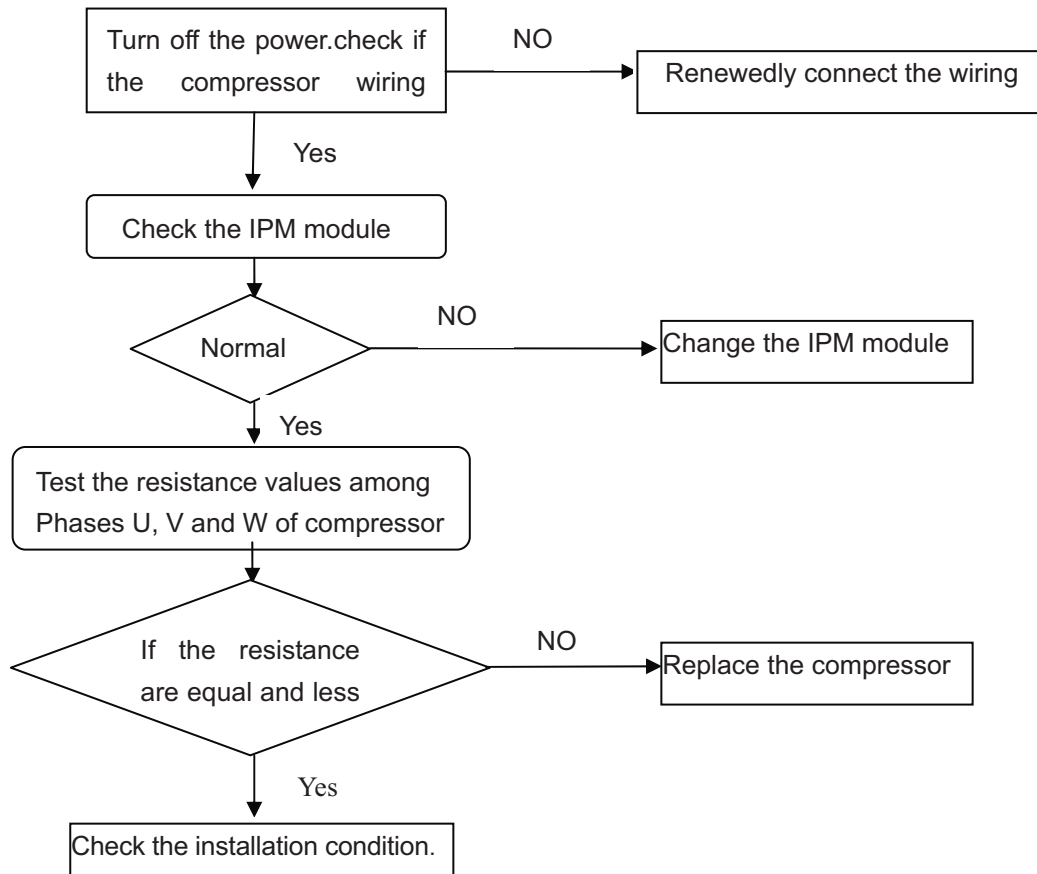

**Check the IPM module method:**

Disconnect the compressor harness connector from the outdoor unit PCB. To disengage the connector, press the protrusion on the connector. Then, to measure resistance between P (+) and N (-) and the U, V and W terminals of the compressor connector with a multi-tester. Evaluate the measurement results for a pass/fail judgment.

N(-)terminal of tester	P(+)	digital	P(+)	UVW	P(-)	UVW	
P(+)	terminal of tester	N(-)	digital	UVW	P(+)	UVW	P(-)

tester)				
Normal resistance	Several kΩ to several MΩ (*)			
Unacceptable resistance	Short (0 Ω) or open			

### 7.3.4 The IPM and outdoor PCB don't communicate or Related Abnormality

<b>outdoor display</b>	LED1 flash 4 times Indoor Display F3
<b>Method of Malfunction Detection</b>	Communication is detected by checking the IPM module and the outdoor PCB
<b>Malfunction Decision Conditions</b>	<ul style="list-style-type: none"> <li>■ The outdoor PCB broken leads to communication fault</li> <li>■ The IPM module broken leads to communication fault</li> </ul>
<b>Supposed Causes</b>	<ul style="list-style-type: none"> <li>■ The outdoor PCB is broken</li> <li>■ The IPM module is broken</li> <li>■ Communication wiring disconnected</li> </ul>
<b>Troubleshooting</b>	<p><b>* Caution</b> Be sure to turn off power switch before connect or disconnect connector, or else parts damage may be occurred.</p>

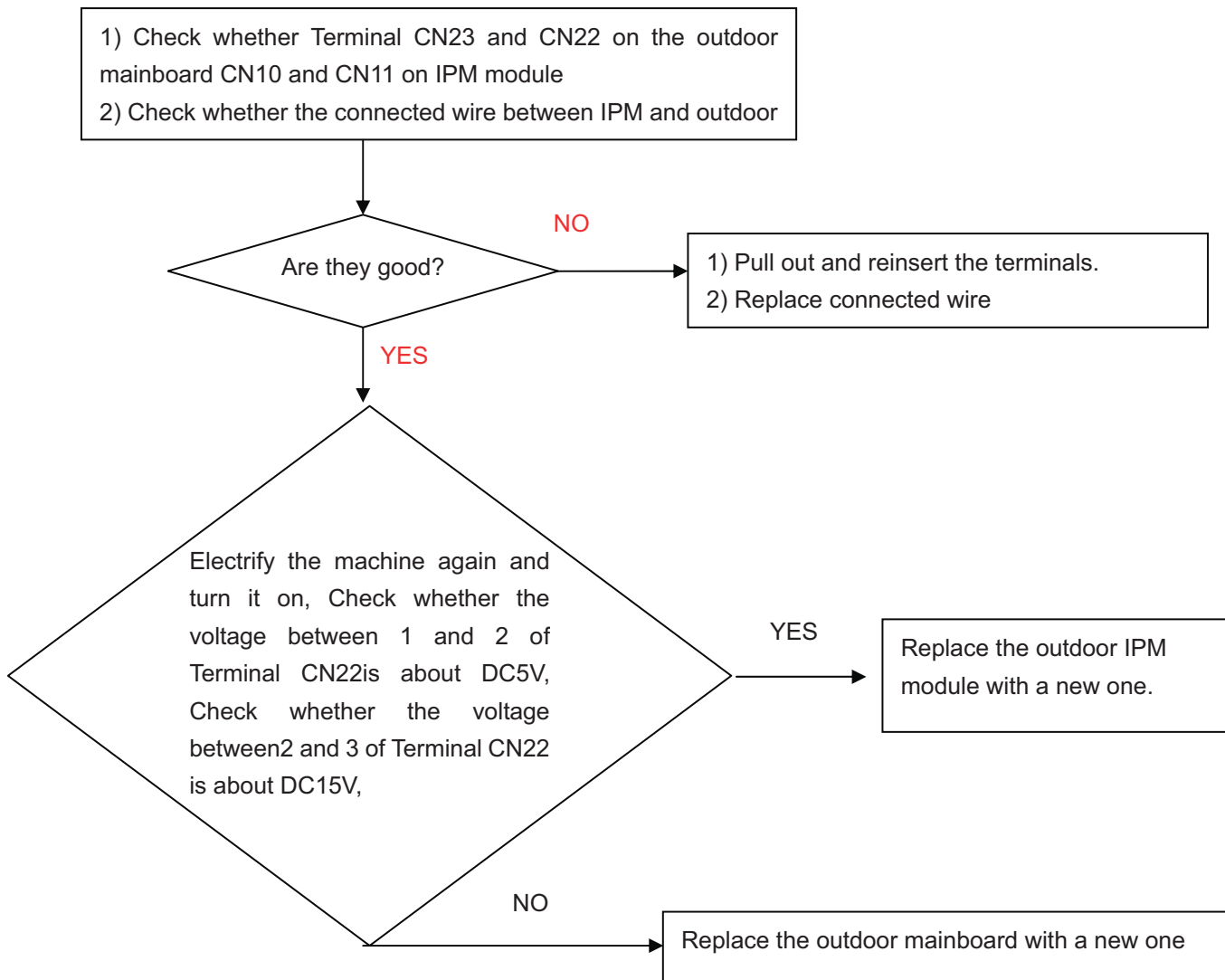

### 7.3.5 Thermistor or Related Abnormality(outdoor unit)

#### Frost-removing temperature sensor failure

Indoor display: F21  
 outdoor display: LED1 flash 10 times:

#### Exhaust temperature sensor failure

Indoor display: F25  
 outdoor display: LED1 flash 13 times:

#### Ambient temperature sensor failure

Indoor display: F6  
 outdoor display: LED1 flash 12 times:

#### Suck temperature sensor failure

Indoor display: F7  
 outdoor display: LED1 flash 11times:

**Method of Malfunction Detection** This type of error is detected by checking the thermistor input voltage to the microcomputer. (A thermistor error is detected by checking the temperature)

**Malfunction Decision Conditions** The thermistor input is above 4.9V or below 0.1V with the power on.  
 \* **Note:** The values may vary slightly in some models

**Supposed Causes**

- Faulty connector connection
- Faulty thermistor
- Faulty PCB

**Troubleshooting** \* **Caution** Be sure to turn off power switch before connect or disconnect connector, or else parts damage may be occurred.

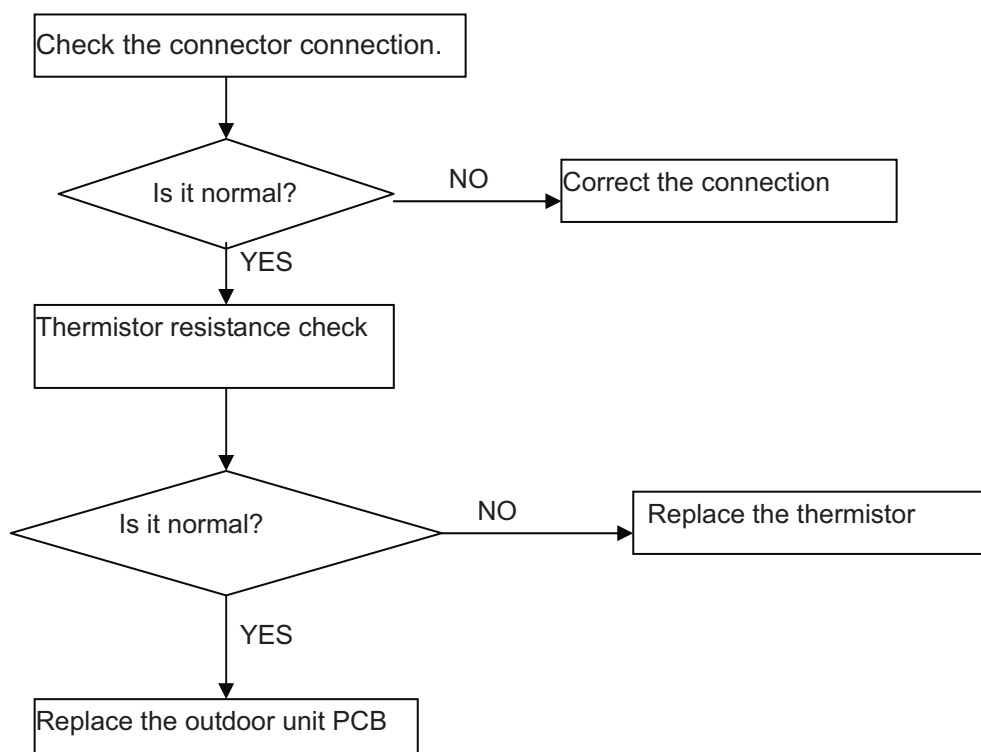

### 7.3.6 Overheat Protection For Exhaust Temperature

<b>Indoor display</b> <b>outdoor display</b>	<b>F4</b> LED1 flash 8 times
<b>Method of Malfunction Detection</b>	the exhaust temperature control is checked with the temperature being detected by the exhaust pipe thermistor
<b>Malfunction Decision Conditions</b>	when the compressor discharge temperature is above 117°C
<b>Supposed Causes</b>	<ul style="list-style-type: none"> <li>■ Electronic expansion valve defective</li> <li>■ Faulty thermistor</li> <li>■ Faulty PCB</li> </ul>

**Troubleshooting** \* Caution Be sure to turn off power switch before connect or disconnect connector, or else parts damage may be occurred.

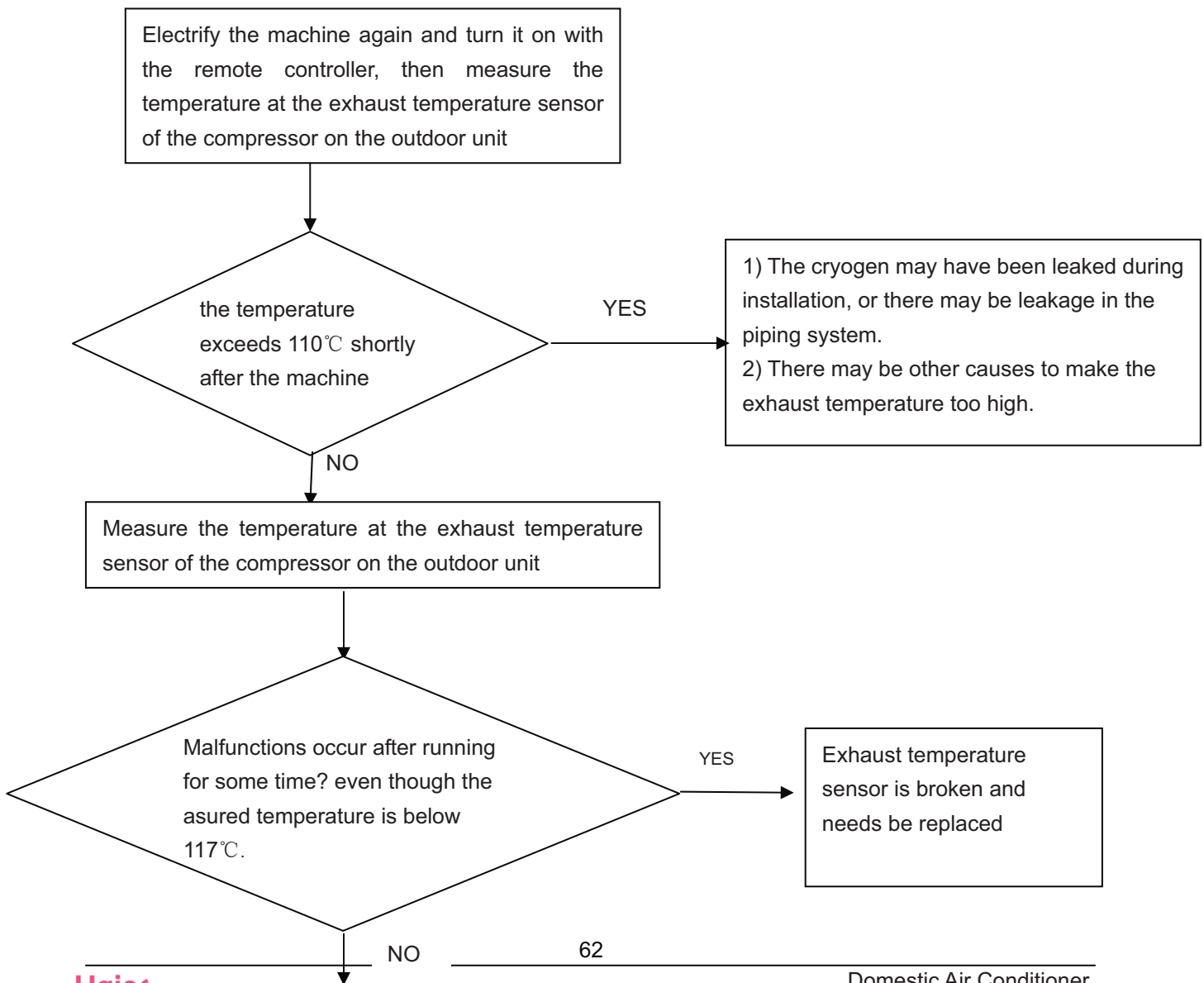

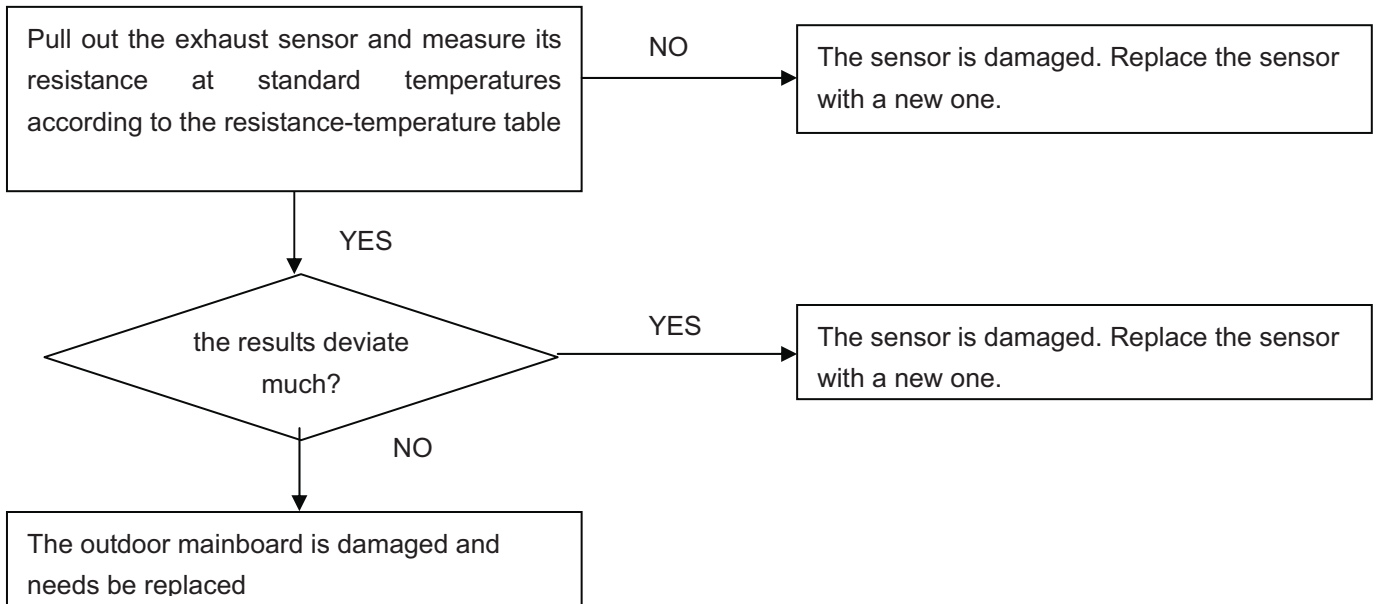

### 7.3.7 The EEPROM Abnormality (Indoor or outdoor unit)

<b>Indoor Display</b>	<p><b>E4:</b> : Indoor EEPROM error</p> <p><b>F12:</b> Outdoor EEPROM error</p>
<b>Method of Malfunction Detection</b>	the Data detected by the EEPROM are used to determine MCU
<b>Malfunction Decision Conditions</b>	when the Data of EEPROM is error or the EEPROM is damaged
<b>Supposed Causes</b>	<ul style="list-style-type: none"> <li>■ Faulty EEPROM data</li> <li>■ Faulty EEPROM</li> <li>■ Faulty PCB</li> </ul>

**Troubleshooting** \* **Caution** Be sure to turn off power switch before connect or disconnect connector, or parts damage may be occurred.

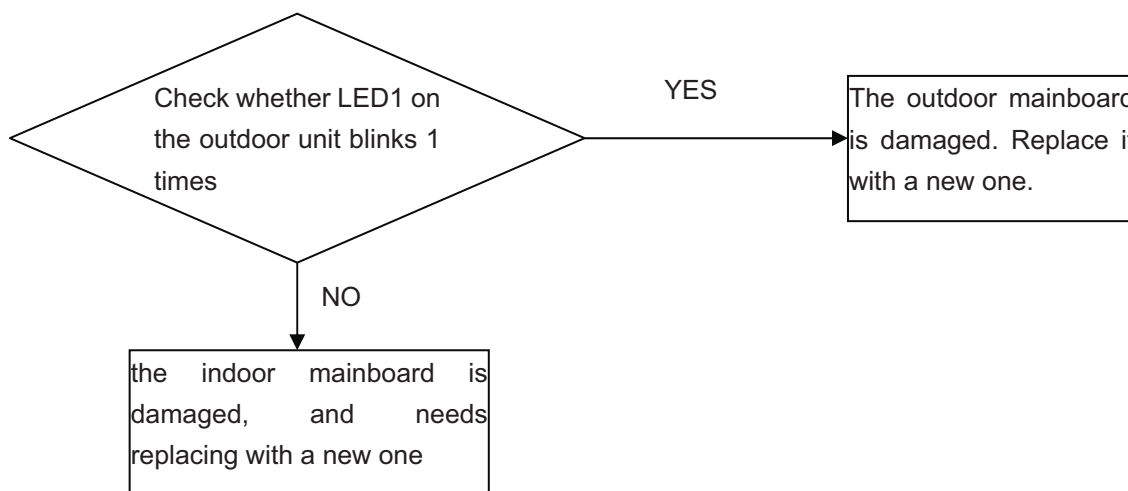





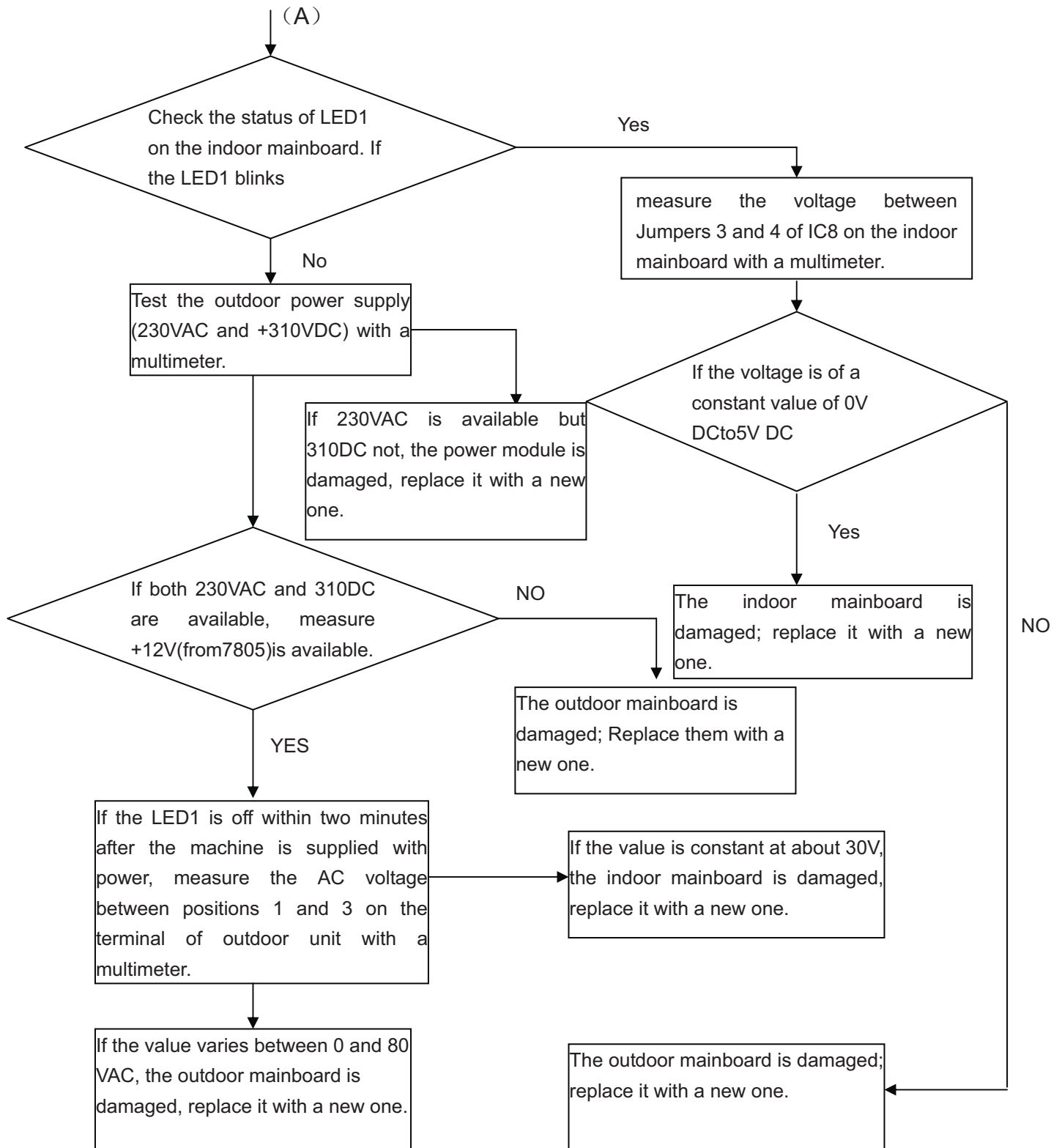

### 7.3.9 Power Supply Over or under voltage fault

<b>Indoor display</b> <b>outdoor display:</b>	<b>F19</b> LED1 flash 6 times
<b>Method of circuit.</b> <b>Malfunction Detection</b>	An abnormal voltage rise or fall is detected by checking the specified voltage detection
<b>Malfunction Decision Conditions</b> <b>Supposed Causes</b>	An voltage signal is fed from the voltage detection circuit to the microcomputer  <ul style="list-style-type: none"> <li>■ Supply voltage not as specified</li> <li>■ the IPM module is broken</li> <li>■ the outdoor PCB is broken</li> </ul>
<b>Troubleshooting</b>	* Caution Be sure to turn off power switch before connect or disconnect connector, or else parts damage may be occurred.

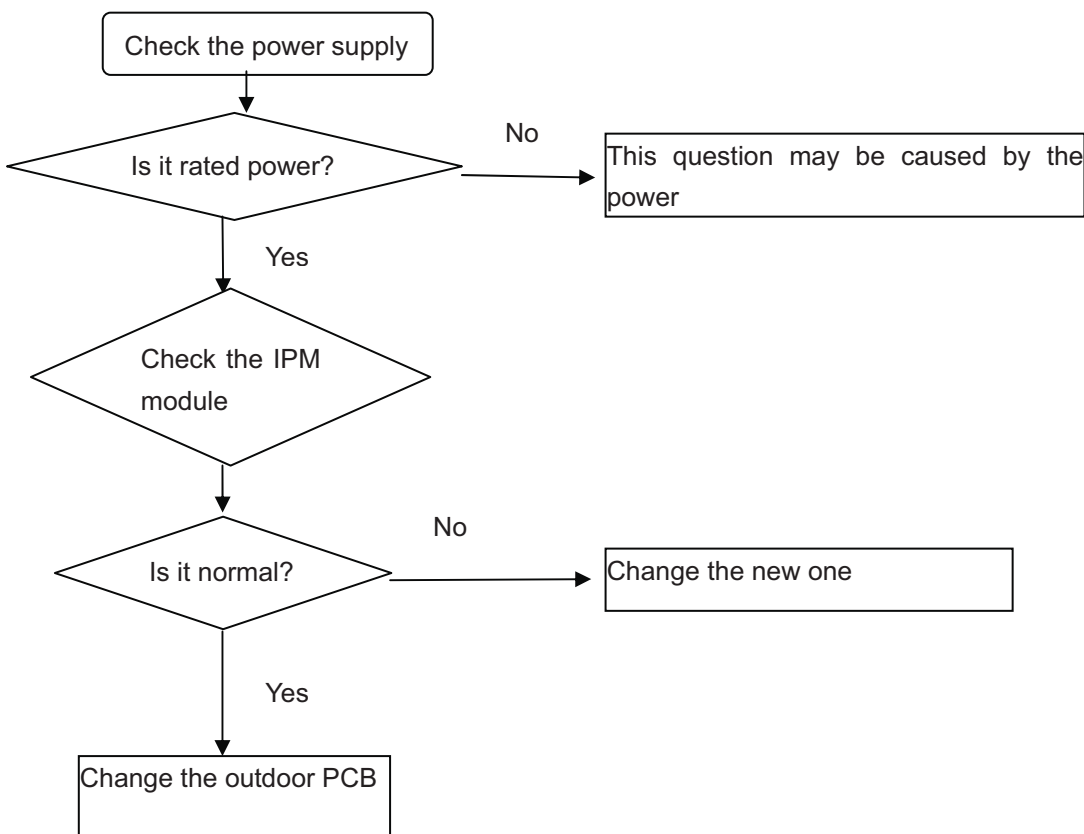

About how to check the IPM module, please refer to IPM protection fault

### 7.3.10 Loop of the station detect error

<b>Outdoor Display</b>	LED1 flash 18 times	Indoor Display	<b>F11</b>
	LED1 flash 19 times	Indoor Display	<b>F28</b>

**Method of Malfunction Detection** The position of the compressor rotor can not detected normally

**Malfunction Decision Conditions** when the The wiring of compressor is wrong or the connection is poor; or the compressor is damaged

- Supposed Causes**
- Faulty The wiring of compressor
  - Faulty compressor
  - Faulty PCB

**Troubleshooting** \* **Caution** Be sure to turn off power switch before connect or disconnect connector, or parts damage may be occurred.

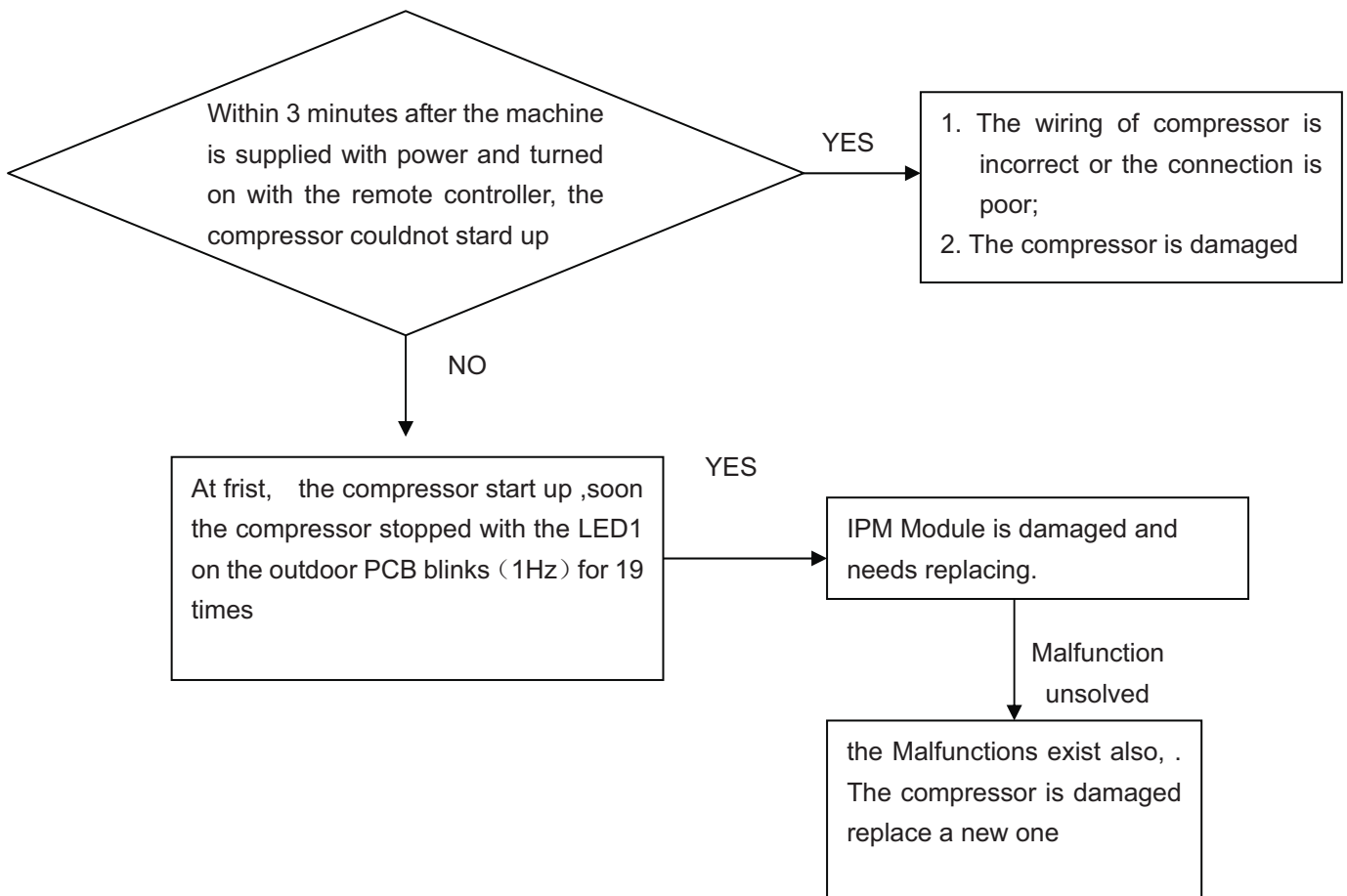

# 10. Appendix

## 10.1 Piping Diagrams

### Cooling mode

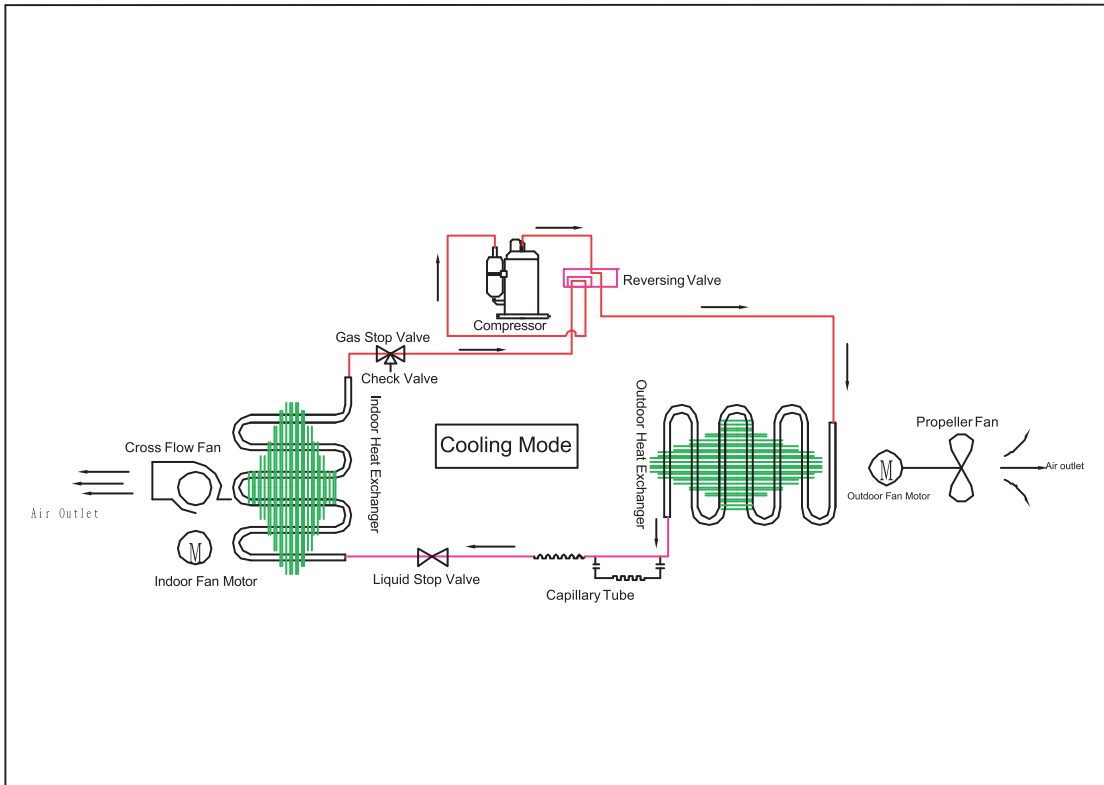

### Heating mode

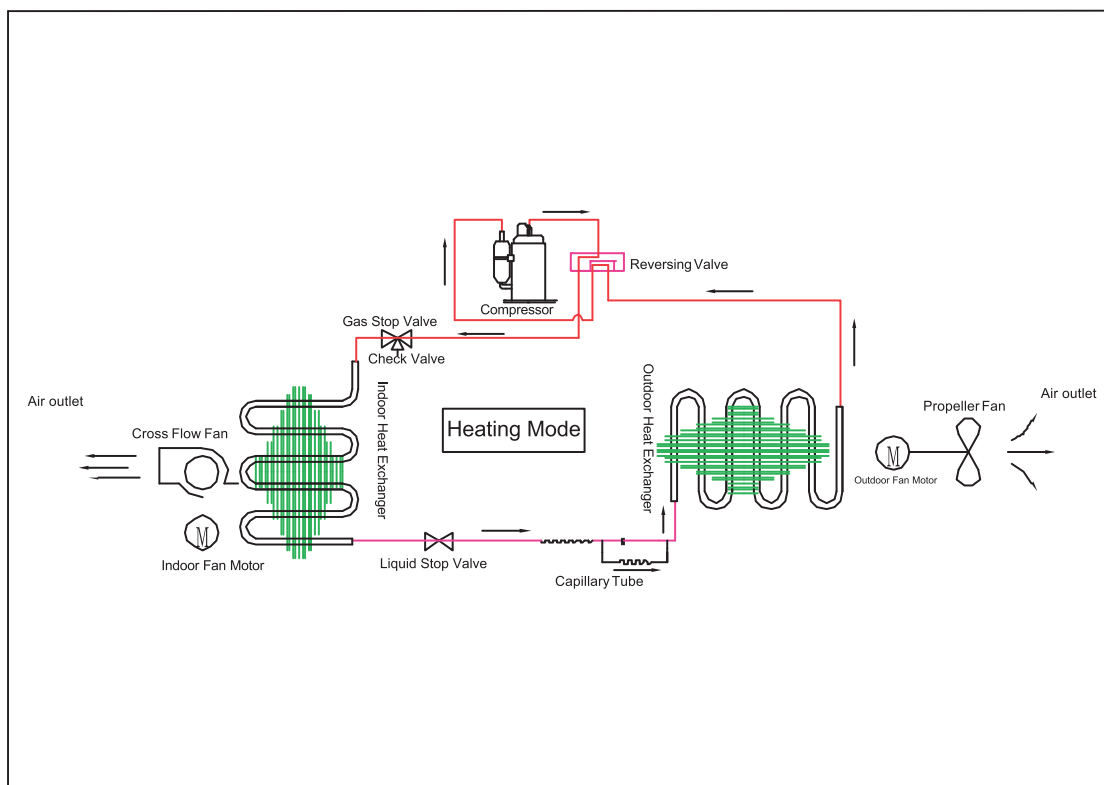

## 10.2 Wiring Diagrams

### 10.2.1. INDOORUNIT FOR12K

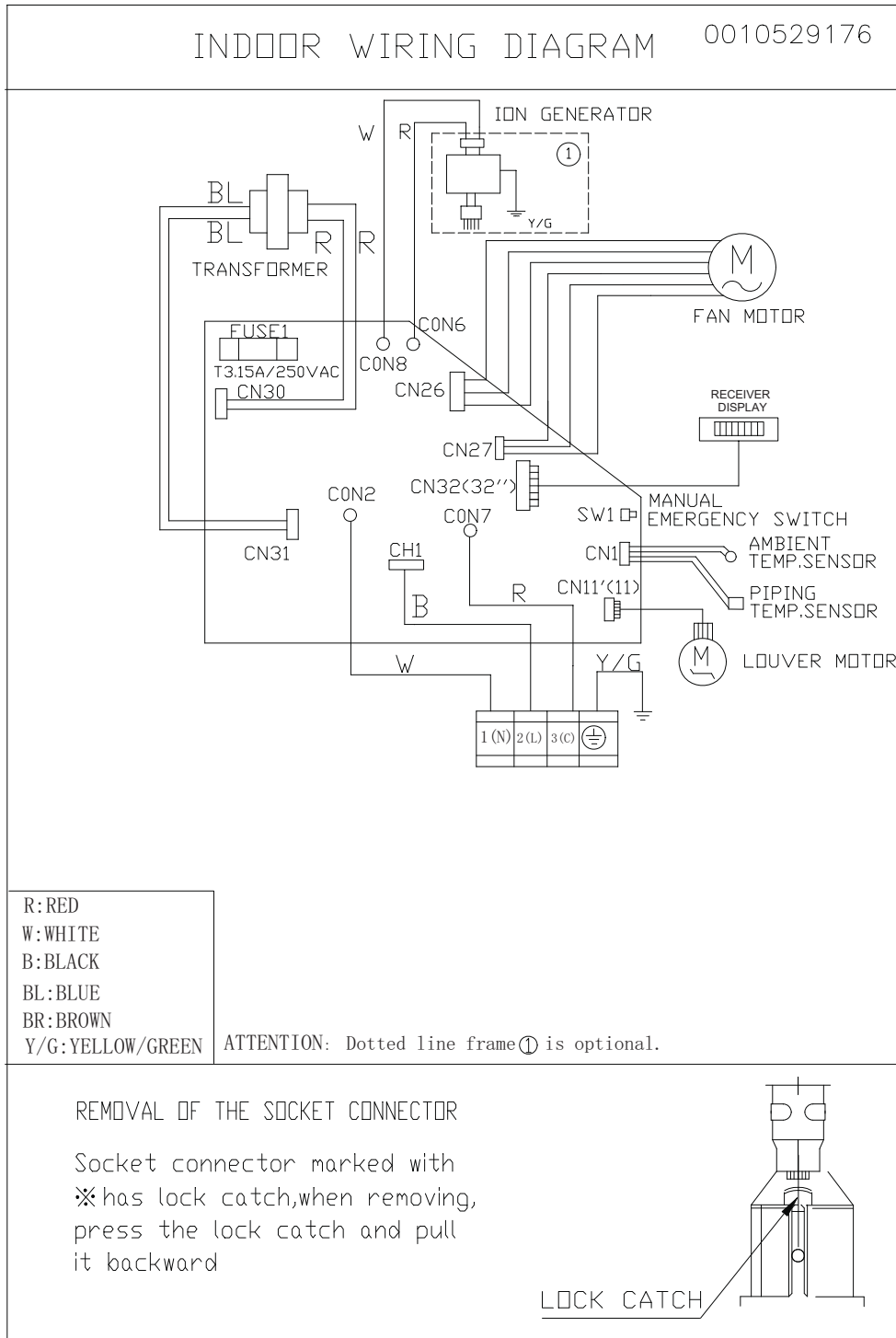

FOR18K

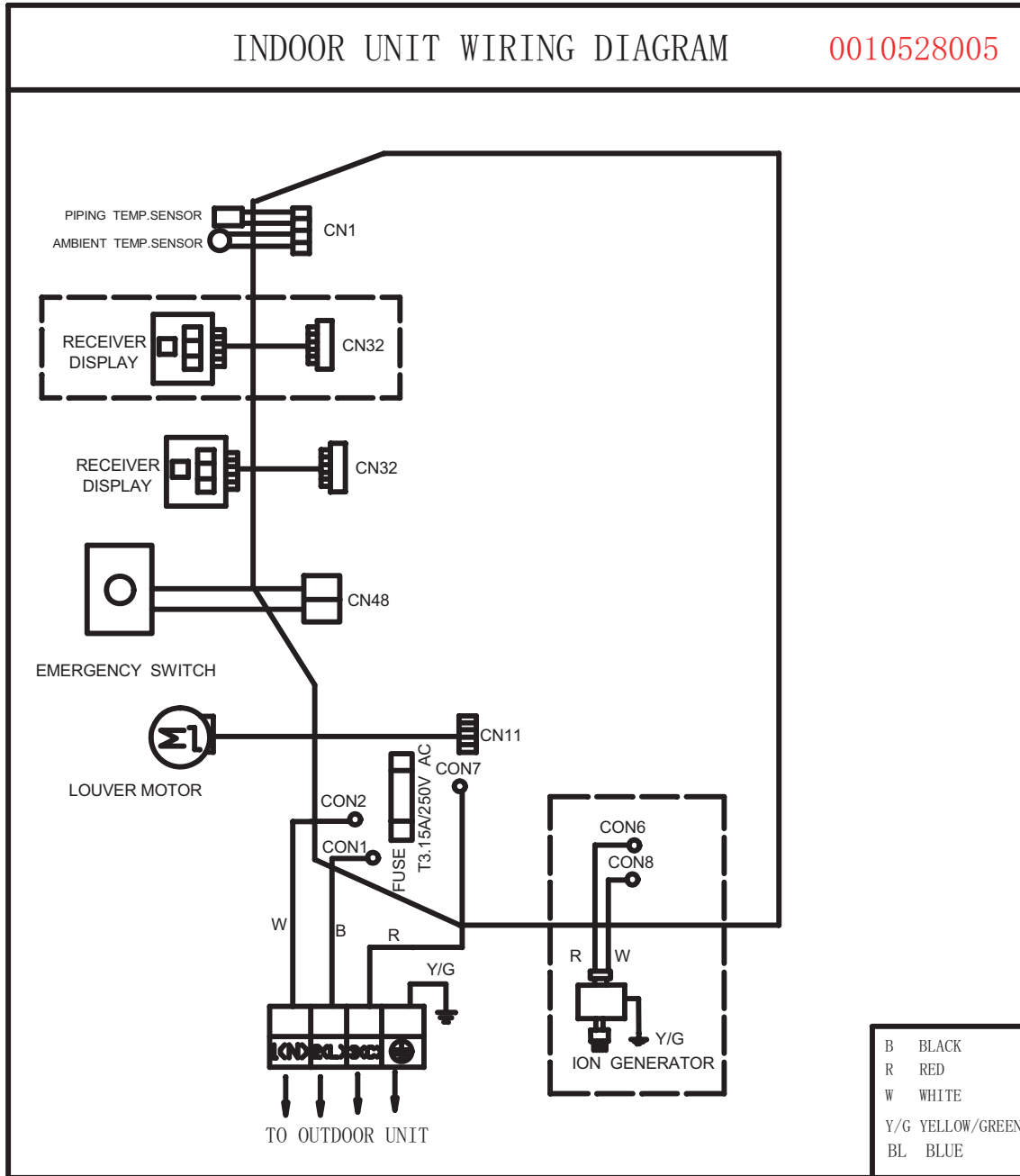

10.2.2. Outdoor unit

FOR12K

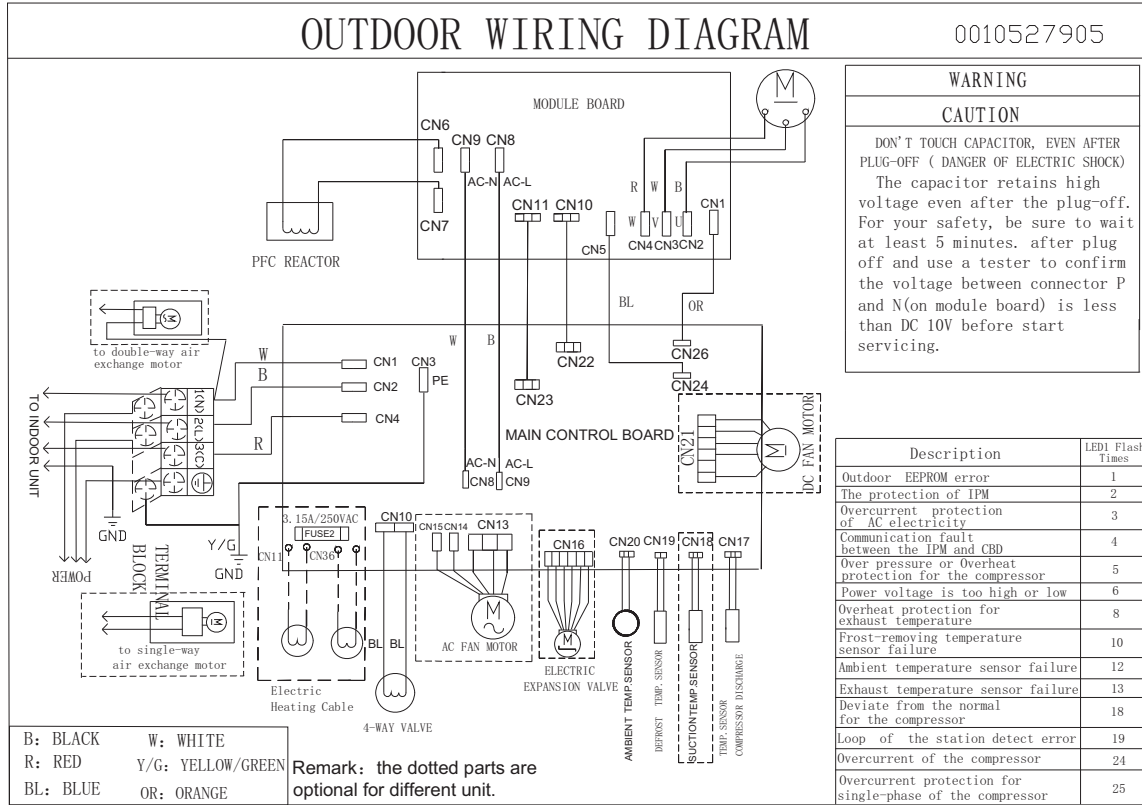



FOR18K

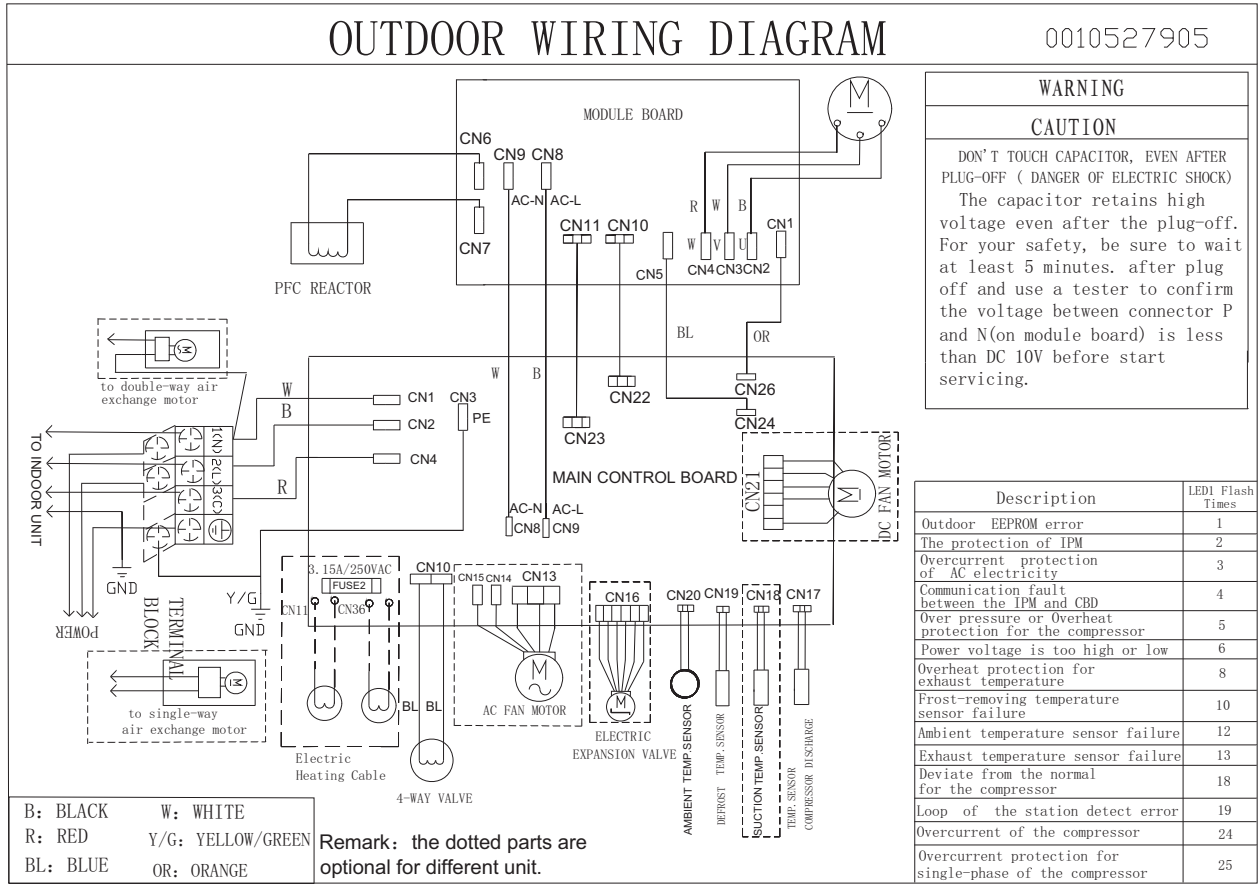

# 10.3. Circuit Diagrams

## 10.3.1. INDOORUNIT FOR12K

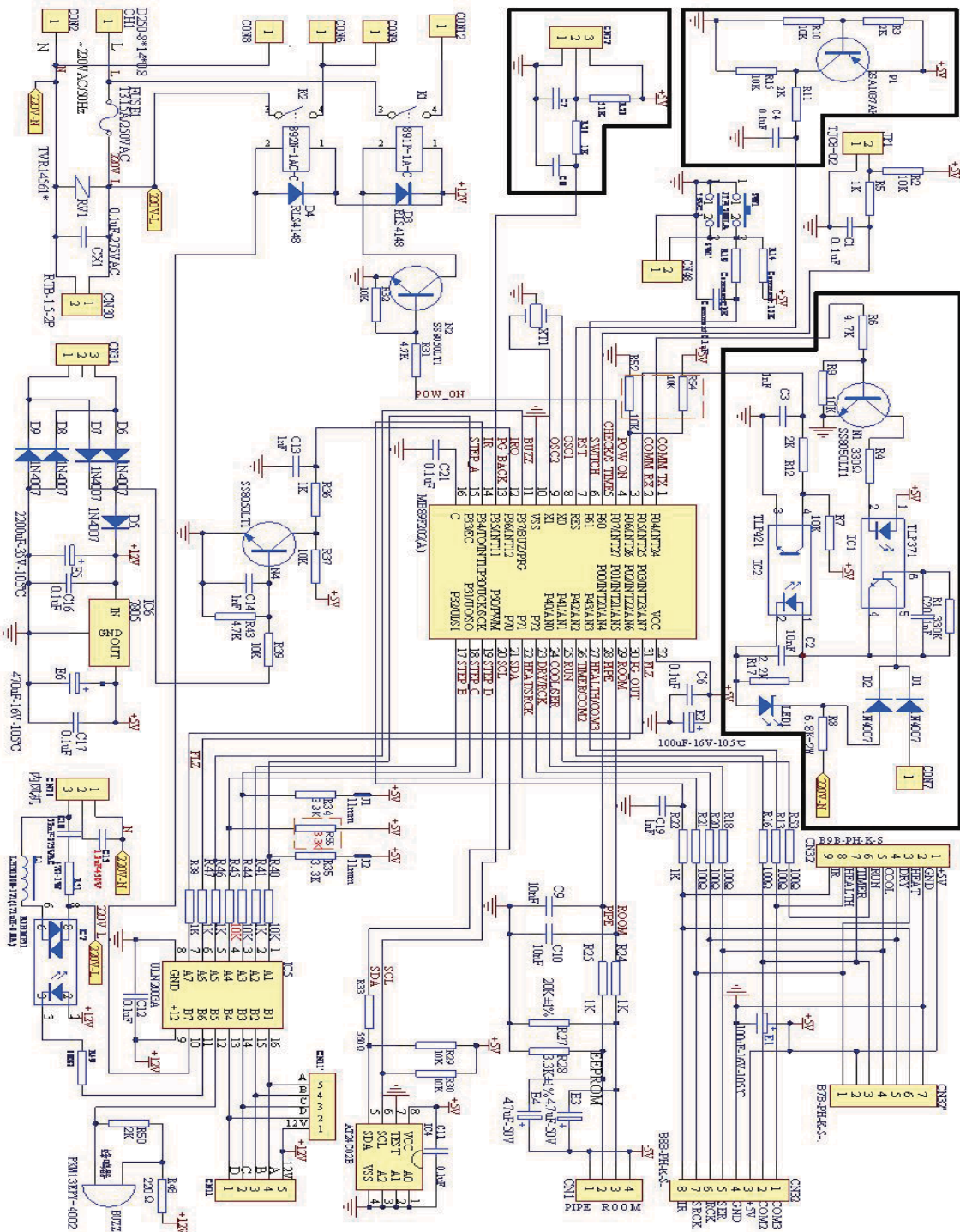

FOR18K

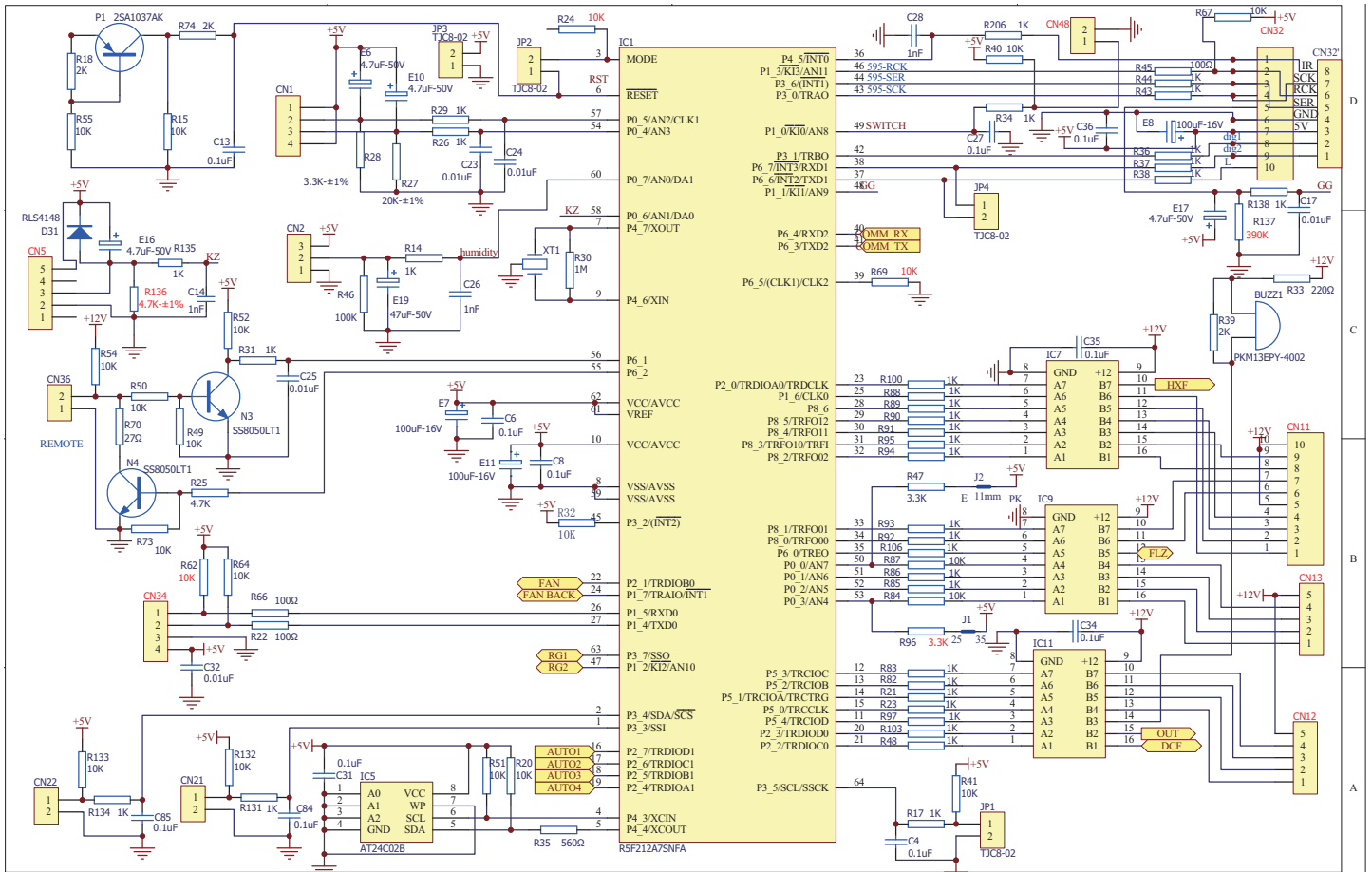

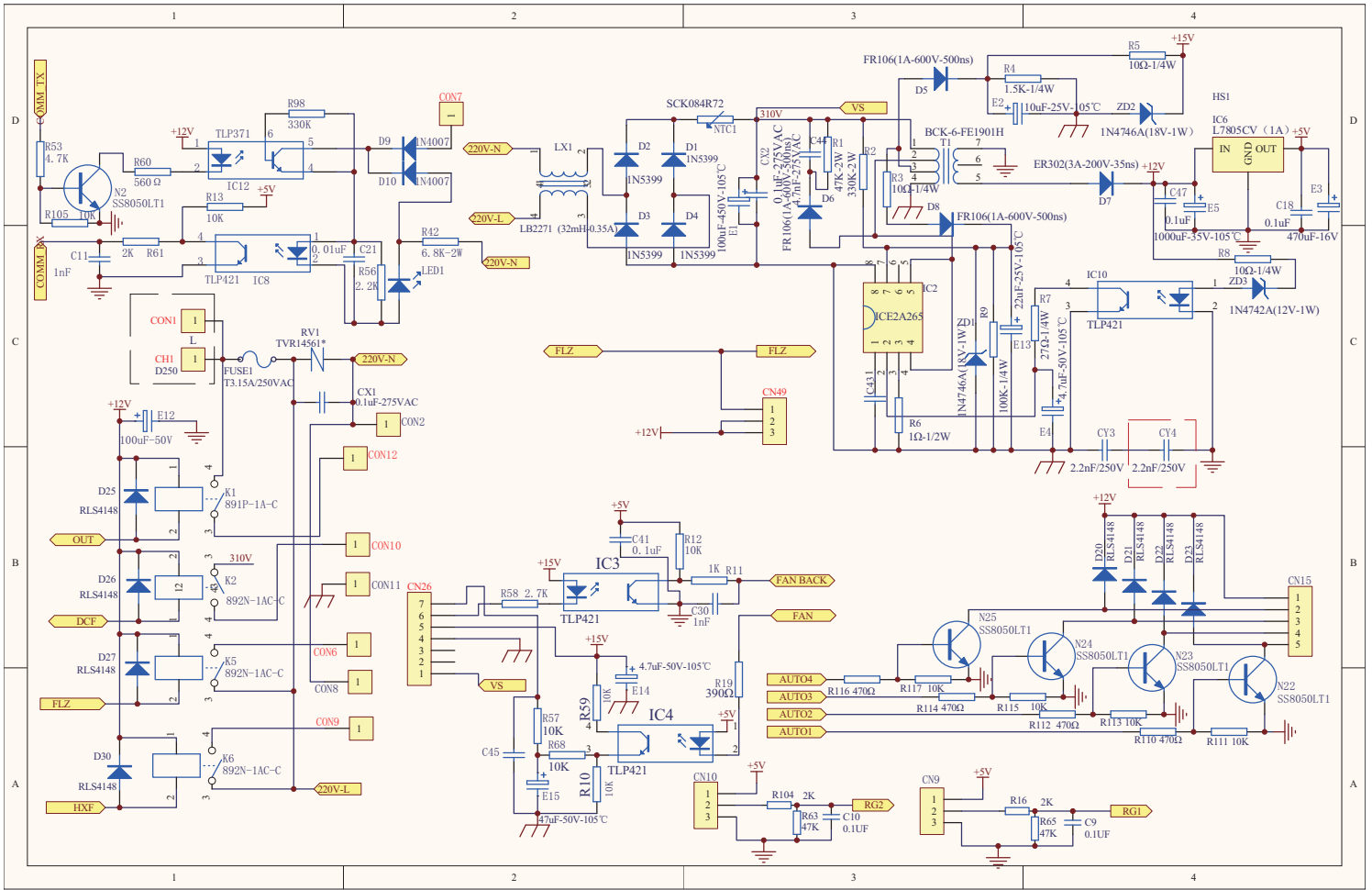

### 10.3.2.OUTDOORUNIT

### FOR12K

### module board Circuit Diagrams

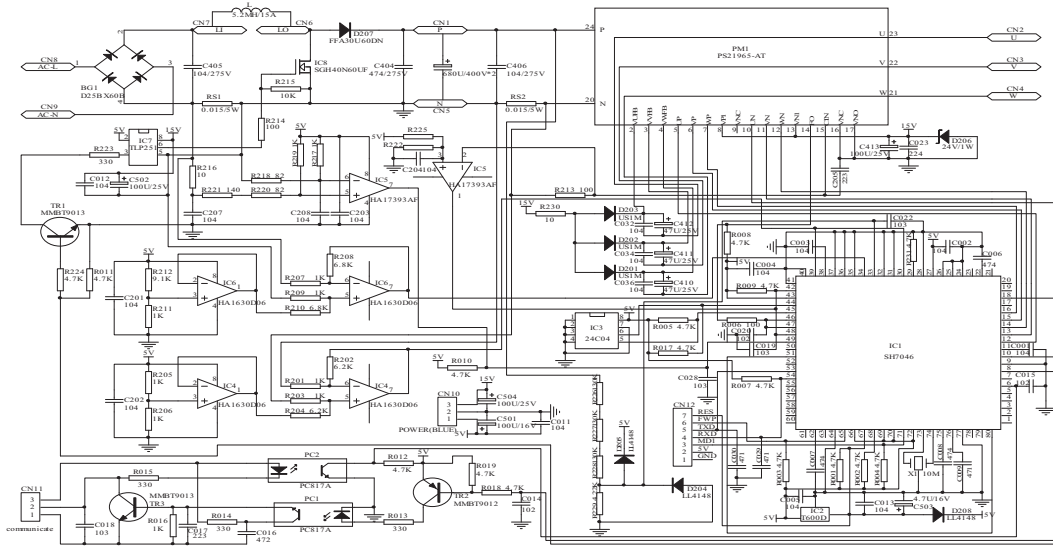

### control board Circuit Diagrams

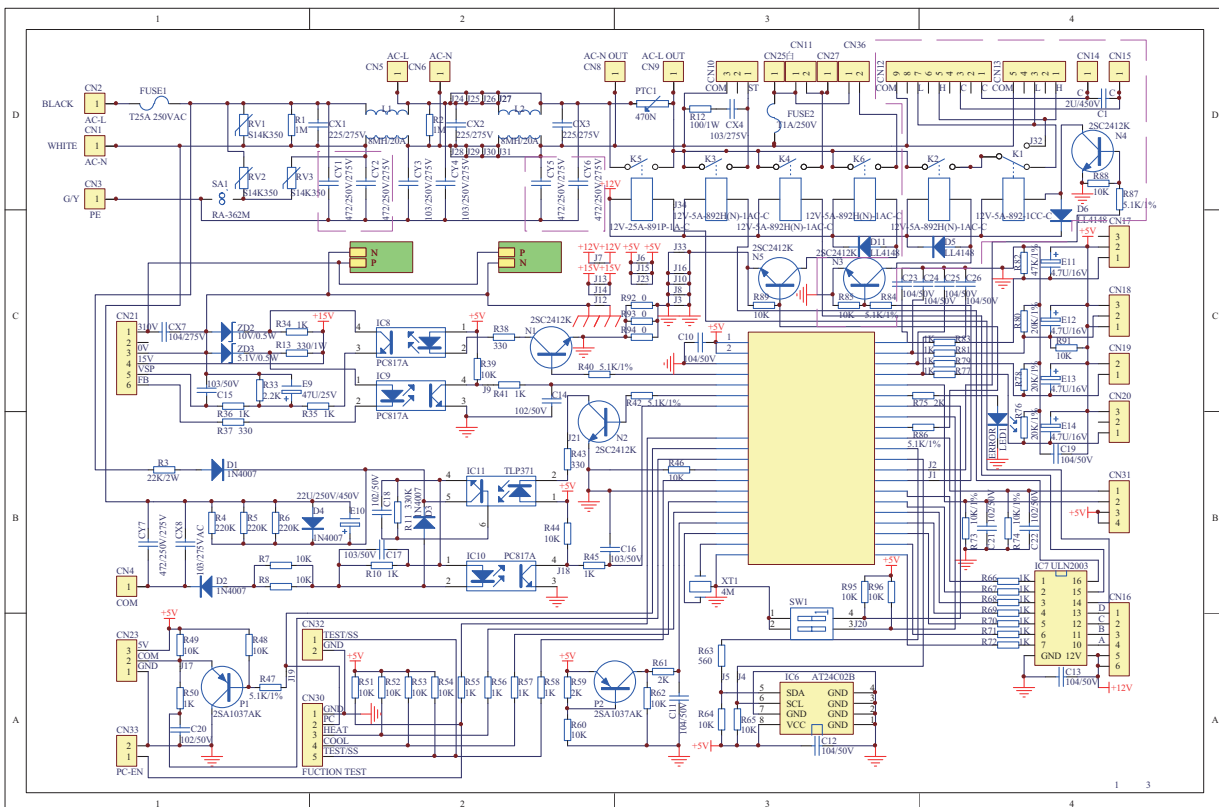

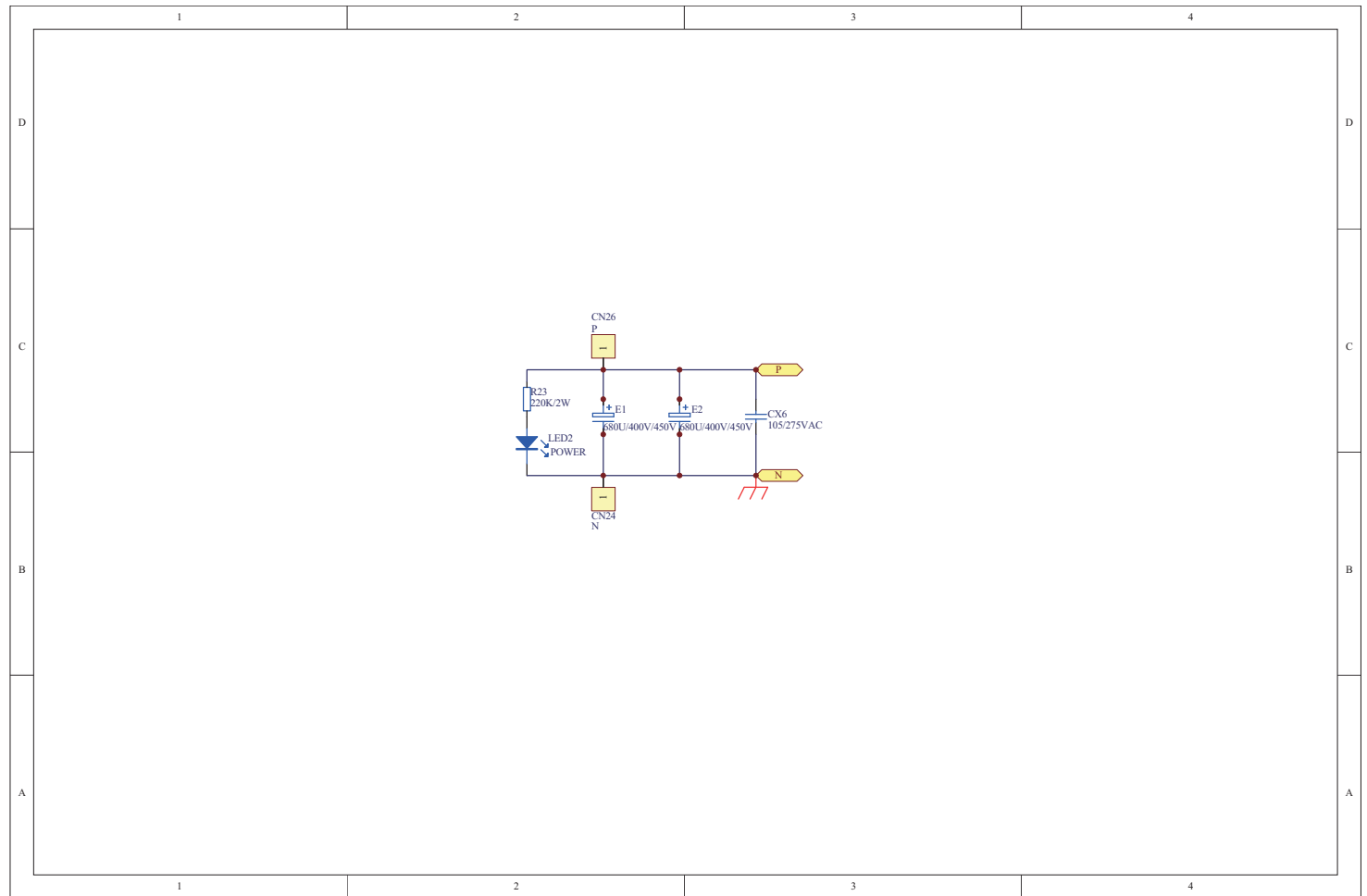
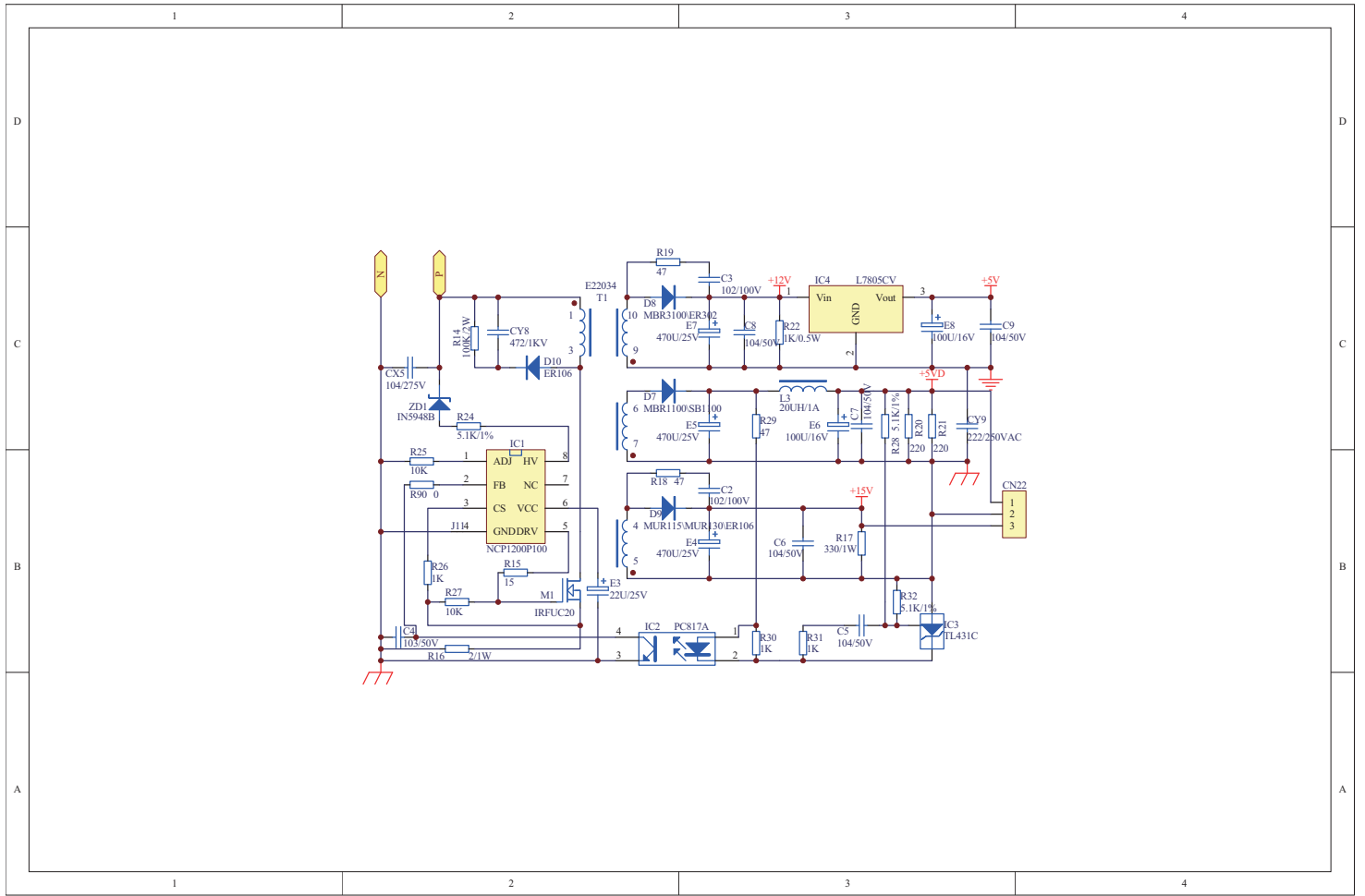

FOR18K

module board Circuit Diagrams

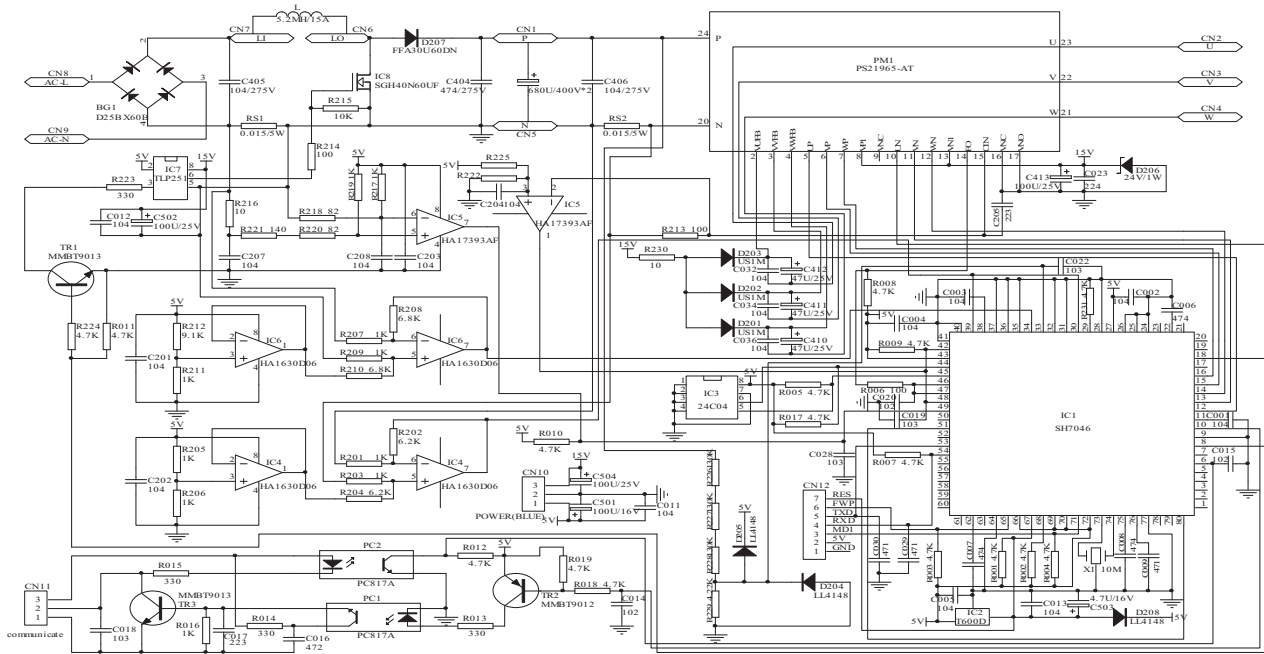

control board Circuit Diagrams

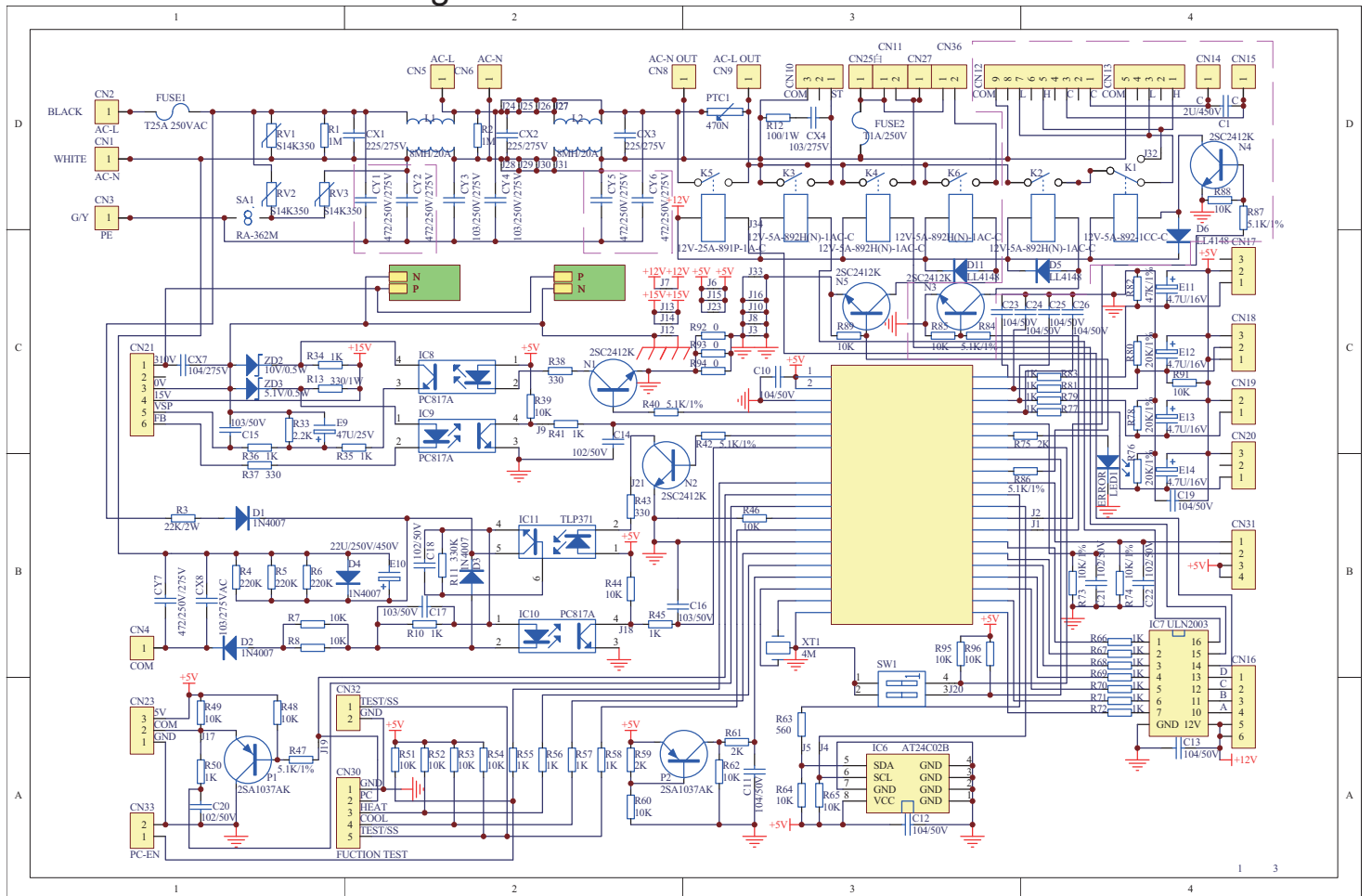





# Sincere Forever

## Haier Group

---

Haier Industrial Park, No.1, Haier Road  
266101, Qingdao, China\_

E-mail: [hractech@haier.com](mailto:hractech@haier.com)

Tel: +86 532 87636960

[Http://www.haier.com](http://www.haier.com)

Edited by: Liu Ming  
Sun Qiang

Signed by: Yang Bifei

Approved by:Wu Hongjin

# Haier

# SERVICE MANUAL

Order No.AC1101S021V0

## Wall mounted Type DC Inverter EA-Series Model No. HSU24VHJ(DB)



### **WARNING**

This service information is designed for experienced repair technicians only and is not designed for use by the general public. It does not contain warnings or cautions to advise non-technical individuals of potential dangers in attempting to service a product. Products powered by electricity should be serviced or repaired only by experienced professional technicians. Any attempt to service or repair the product or products dealt with in this service information by anyone else could result in serious injury or death.

©2011(Qingdao Haier Air Conditioner General corp.,Ltd)  
All right reserved .Unauthorized copying and distribution is a violation of law

## Haier Group

# Table of Contents

<b>1. Introduction</b> .....	1
<b>2. List of Functions</b> .....	6
<b>3. Specifications</b> .....	7
<b>4. Printed Circuit Board Connector Wiring Diagram</b> .....	9
<b>5. Functions and Control</b> .....	15
5.1 Main functions and control specifications of indoor unit .....	15
5.2 Main functions and control specifications of outdoor unit .....	21
5.3 Function of main thermistor .....	26
5.4 Value of thermistor .....	27
<b>6. System Configuration</b> .....	42
6.1 System Configuration.....	42
6.2 Instruction.....	42
<b>7. Service Diagnosis</b> .....	50
7.1 Caution for diagnosis.....	50
7.2 Problem Symptoms and Measures .....	50
7.3 Error codes and description indoor display .....	51
<b>8. Installations</b> .....	67
<b>9. Removal Procedure</b> .....	71
9.1 For indoor unit .....	71
9.2 For outdoor unit .....	90
<b>10. Wiring Diagrams</b> .....	103
10.1 Indoor Unit .....	103
10.2 Outdoor Unit .....	104
<b>11. Circuit Diagrams</b> .....	105
<b>12. Description of Coding rules of Unit Model</b> .....	110

# 1. Introduction

## 1.1 Safety Cautions

Be sure to read the following safety cautions before conducting repair work.

The caution items are classified into “Warning” and “Caution”. The “Warning” items are especially important since they can lead to death or serious injury if they are not followed closely. The “Caution” items can also lead to serious accidents under some conditions if they are not followed. Therefore, be sure to observe all the safety caution items described below.

About the pictograms

△ This symbol indicates an item for which caution must be exercised.

The pictogram shows the item to which attention must be paid.

○ This symbol indicates a prohibited action.





The prohibited item or action is shown inside or near the symbol.







● This symbol indicates an action that must be taken, or an instruction.

The instruction is shown inside or near the symbol.

After the repair work is complete, be sure to conduct a test operation to ensure that the equipment operates normally, and explain the cautions for operating the product to the customer.



### 1.1.1 Caution in Repair

Warning	
<p>Be sure to disconnect the power cable plug from the plug socket before disassembling the equipment for a repair.</p> <p>Working on the equipment that is connected to a power supply can cause an electrical shock.</p> <p>If it is necessary to supply power to the equipment to conduct the repair or inspecting the circuits, do not touch any electrically charged sections of the equipment.</p>	
<p>If the refrigerant gas discharges during the repair work, do not touch the discharging refrigerant gas. The refrigerant gas can cause frostbite.</p>	
<p>When disconnecting the suction or discharge pipe of the compressor at the welded section, release the refrigerant gas completely at a well-ventilated place first.</p> <p>If there is a gas remaining inside the compressor, the refrigerant gas or refrigerating machine oil discharges when the pipe is disconnected, and it can cause injury.</p>	
<p>If the refrigerant gas leaks during the repair work, ventilate the area. The refrigerant gas can generate toxic gases when it contacts flames.</p>	
<p>The step-up capacitor supplies high-voltage electricity to the electrical components of the outdoor unit.</p> <p>Be sure to discharge the capacitor completely before conducting repair work. A charged capacitor can cause an electrical shock.</p>	
<p>Do not start or stop the air conditioner operation by plugging or unplugging the power cable plug.</p> <p>Plugging or unplugging the power cable plug to operate the equipment can cause an electrical shock or fire.</p>	

Warning	
Do not repair the electrical components with wet hands. Working on the equipment with wet hands can cause an electrical shock.	
Do not clean the air conditioner by splashing water. Washing the unit with water can cause an electrical shock.	
Be sure to provide the grounding when repairing the equipment in a humid or wet place, to avoid electrical shocks.	
Be sure to turn off the power switch and unplug the power cable when cleaning the equipment. The internal fan rotates at a high speed, and cause injury.	
Do not tilt the unit when removing it. The water inside the unit can spill and wet the furniture and floor.	
Be sure to check that the refrigerating cycle section has cooled down sufficiently before conducting repair work. Working on the unit when the refrigerating cycle section is hot can cause burns.	
Use the welder in a well-ventilated place. Using the welder in an enclosed room can cause oxygen deficiency.	



### 1.1.2 Cautions Regarding Products after Repair

Warning	
Be sure to use parts listed in the service parts list of the applicable model and appropriate tools to conduct repair work. Never attempt to modify the equipment. The use of inappropriate parts or tools can cause an electrical shock, excessive heat generation or fire.	
When relocating the equipment, make sure that the new installation site has sufficient strength to withstand the weight of the equipment. If the installation site does not have sufficient strength and if the installation work is not conducted securely, the equipment can fall and cause injury.	
Be sure to install the product correctly by using the provided standard installation frame. Incorrect use of the installation frame and improper installation can cause the equipment to fall, resulting in injury.	For integral units only
Be sure to install the product securely in the installation frame mounted on a window frame. If the unit is not securely mounted, it can fall and cause injury.	For integral units only

Warning	
<p>Be sure to use an exclusive power circuit for the equipment, and follow the technical standards related to the electrical equipment, the internal wiring regulations and the instruction manual for installation when conducting electrical work.</p> <p>Insufficient power circuit capacity and improper electrical work can cause an electrical shock or fire.</p>	
<p>Be sure to use the specified cable to connect between the indoor and outdoor units. Make the connections securely and route the cable properly so that there is no force pulling the cable at the connection terminals.</p> <p>Improper connections can cause excessive heat generation or fire.</p>	
<p>When connecting the cable between the indoor and outdoor units, make sure that the terminal cover does not lift off or dismount because of the cable.</p> <p>If the cover is not mounted properly, the terminal connection section can cause an electrical shock, excessive heat generation or fire.</p>	
<p>Do not damage or modify the power cable.</p> <p>Damaged or modified power cable can cause an electrical shock or fire. Placing heavy items on the power cable, and heating or pulling the power cable can damage the cable.</p>	
<p>Do not mix air or gas other than the specified refrigerant (R-410A / R22) in the refrigerant system.</p> <p>If air enters the refrigerating system, an excessively high pressure results, causing equipment damage and injury.</p>	
<p>If the refrigerant gas leaks, be sure to locate the leak and repair it before charging the refrigerant. After charging refrigerant, make sure that there is no refrigerant leak.</p> <p>If the leak cannot be located and the repair work must be stopped, be sure to perform pump-down and close the service valve, to prevent the refrigerant gas from leaking into the room. The refrigerant gas itself is harmless, but it can generate toxic gases when it contacts flames, such as fan and other heaters, stoves and ranges.</p>	
<p>When replacing the coin battery in the remote controller, be sure to disposed of the old battery to prevent children from swallowing it.</p> <p>If a child swallows the coin battery, see a doctor immediately.</p>	

Caution	
<p>Installation of a leakage breaker is necessary in some cases depending on the conditions of the installation site, to prevent electrical shocks.</p>	
<p>Do not install the equipment in a place where there is a possibility of combustible gas leaks.</p> <p>If a combustible gas leaks and remains around the unit, it can cause a fire.</p>	
<p>Be sure to install the packing and seal on the installation frame properly. If the packing and seal are not installed properly, water can enter the room and wet the furniture and floor.</p>	<p>For integral units only</p>

### 1.1.3 Inspection after Repair

Warning	
<p>Check to make sure that the power cable plug is not dirty or loose, then insert the plug into a power outlet all the way.</p> <p>If the plug has dust or loose connection, it can cause an electrical shock or fire.</p>	
<p>If the power cable and lead wires have scratches or deteriorated, be sure to replace them.</p> <p>Damaged cable and wires can cause an electrical shock, excessive heat generation or fire.</p>	





Warning	
<p>Do not use a joined power cable or extension cable, or share the same power outlet with other electrical appliances, since it can cause an electrical shock, excessive heat generation or fire.</p>	

Caution	
<p>Check to see if the parts and wires are mounted and connected properly, and if the connections at the soldered or crimped terminals are secure. Improper installation and connections can cause excessive heat generation, fire or an electrical shock.</p>	
<p>If the installation platform or frame has corroded, replace it. Corroded installation platform or frame can cause the unit to fall, resulting in injury.</p>	
<p>Check the grounding, and repair it if the equipment is not properly grounded. Improper grounding can cause an electrical shock.</p>	
<p>Be sure to measure the insulation resistance after the repair, and make sure that the resistance is 1 M ohm or higher.</p> <p>Faulty insulation can cause an electrical shock.</p>	
<p>Be sure to check the drainage of the indoor unit after the repair.</p> <p>Faulty drainage can cause the water to enter the room and wet the furniture and floor.</p>	

### 1.1.4 Using Icons

Icons are used to attract the attention of the reader to specific information. The meaning of each icon is described in the table below:

### 1.1.5 Using Icons List

Icon	Type of Information	Description
 Note:	Note	A "note" provides information that is not indispensable, but may nevertheless be valuable to the reader, such as tips and tricks.
 Caution	Caution	A "caution" is used when there is danger that the reader, through incorrect manipulation, may damage equipment, lose data, get an unexpected result or has to restart (part of) a procedure.
 Warning	Warning	A "warning" is used when there is danger of personal injury.
	Reference	A "reference" guides the reader to other places in this binder or in this manual, where he/she will find additional information on a specific topic.



## 2. List of Functions

Category	Functions	HSU09VHJ(DB)
Healthy negative ion	make your room full of an abundance natural negative ions.	Y
Left&right flow	With specialized motor and flaps, the airflow can be adjusted .	N
Child lock	Avoid the child's wrong operation on the remote controller	Y
3D air flow	The 3D airflow is able to deliver the airflow horizontally and vertically.	N
24Hour timer	Use the timer function to set on,or off,or from on to off,or from off to on	Y
Auto restart	automatic return to previous operation conditions after asudden power blackou	Y
Easy clean design	The panel is easy to wash and the airflow vents can be detached easily	Y
Intelligent air	With single-blade technology ,the airflow can be adjusted not to blow directly	Y
Anti-mold filter	Catches most small particles and remove unpleasant odors effectively.	Y
Sleep mode	The setting temprature and the indoor noise can be adjusted to a more comfortable level when you set the "sleep mode"during night sleep	Y
4 Fan setting	Select the fan speed LO,MED,HI,AUTO	Y
Entire auto mode	You can set a temprature value,with which the unit can be adjusted the operation mode automatically	Y
Auto mode	adjust the last fixed operation mode automatically.	N
ESF filter	Trap harmful dust and remove unpleasant odors effectively	N
Power mode	Quick cooling or heating	Y
Soft mode	lower noise operation condition	Y
Negative ion filter	Generate negative ions by the filter.	N
Constant temperature dehumidification	Make dehumidifying in the room while keeping the constant temperature inside	N

Note: Y: Holding Functions

N : No Functions

### 3. Specifications

Model		HSU24VHJ(DB)	
		Cooling	Heating
Capacity Rated (Min.~Max.)	kW	6.4(2.2~6.7)	6.7(2.2~7.0)
	Btu/h	22000(7500~23000)	23000(7500~24000)
	kcal/h	5504(1892~5762)	5762(1892~6020)
Moisture Removal	pints/h	9.68	---
Running Current (Rated)	A	10.0	9.8
Power Consumption Rated	W	2250(300~2400)	2200(360~2700)
Power Factor	%	96	97
SEER/HSPF	Btu/(h.w)	16	9
Piping Connections (external diameter)	Liquid	inches	3/8
	Gas	inches	5/8
	Drain	inches	5/8
Heat Insulation		Both Liquid and Gas Pipes	
Max. Piping Length	inches	98 7/16	
Max. Level Difference	inches	59 1/16	
Chargeless	inches	29 1/2	
Amount of Additional Charge of Refrigerant	pounds/inches	0.02	

Indoor Unit			
Front Panel Color		White	
Air Flow Rate	m <sup>3</sup> /min(cfm)	H	11.3(398.9)      12.3(434.2)
		M	10.4(367.1)      11.3 (398.9)
		L	9.4(331.8)      10.3(363.6)
Fan	Type		Cross Flow Fan
	Motor Output ( upper/lower )	W	20
	Speed	Steps	4 Steps and Auto
Air Direction Control		Horizontal / Downward	
Air Filter		Removable / Washable / Mildew Proof	
Run current ( rated )	A	0.15	
Power consumption	W	33	
Power factor	%	96	
Temperature Control		Microcomputer Control	
Dimensions (H×W×D)	inches	41 3/16X11 3/4X9 13/32	
Packaged Dimensions (H×W×D)	inches	44 3/8X15 1/4X13 1/2	
Weight	pounds	28.6	
Gross Weight	pounds	36.3	
Operation Sound	H / M / L	dB(A)      50/47/45	
Sound Power	H(cooling/ heating)	dB(A)      60	

Outdoor Unit				
Casing Color			White	
Compressor	Type		rotary Compressor	
	Model		SNB130FGYM2	
	Motor Output	W	900	
RefrigerantOil	Model		FV50S	
	Charge	pints	0.88	
Refrigerant	Model		R410a	
	Charge	pounds	3.52	
Air Flow Rate (H/L)	m <sup>3</sup> /min		51.7	51.7
	cfm		1825.0	1825.0
Fan	Type		Propeller	
	Motor Output	W	35	
Running Current (Rated)		A	9.5	9.1
Power Consumption (Rated)		W	2120	1970
Power Factor		%	98	98
Starting Current		A	27	
Dimensions (H×W×D)		inches	33 7/8X12 1/8X28 3/4	
Packaged Dimensions (H×W×D)		inches	39 3/16X16 1/2X32 1/16	
Weight		pounds	106.04	
Gross Weight		pounds	114.84	
OperationSound	H/L	dB(A)	60	60
Sound Power	H	dB(A)	70	70

Note: The data are based on the conditions shown in the table below.

Cooling	Heating	Piping Length
Indoor ; 27°CDB/19°CWB Outdoor ; 35°CDB/24°CWB	Indoor ; 20°CDB Outdoor ; 7°CDB/6°CWB	5 m

Conversion Formulae
kcal/h=kW×860
Btu/h=kW×3414
cfm=m <sup>3</sup> /min×35.3

## 4. Printed Circuit Board Connector Wiring Diagram

### 4.1 : Indoor unit Connectors

#### Connectors

##### PCB(1) (Control PCB)

- 1) CN26 Connector for fan motor
- 2) CN1 Connector for heat exchanger thermistor and Room temperature thermistor
- 3) CN11` Connector for UP&DOWN STEP motor
- 4) CON2 Connector for power N wire
- 5) CON1 Connector for power L
- 6) CN32 Connector for display board
- 7) C0N6,C0N8 Connector for ions generator

#### Note: Other designations

##### PCB(1) (INdoor Control PCB)

- 1) CN48 Connector for Forced operation ON / OFF switch
- 2) J1 Select 25 or 35
- 3) LED1 communicate display light
- 4) RV1 Varistor
- 5) FUSE1 Fuse 3.15A/250VAC

# PCB(1)

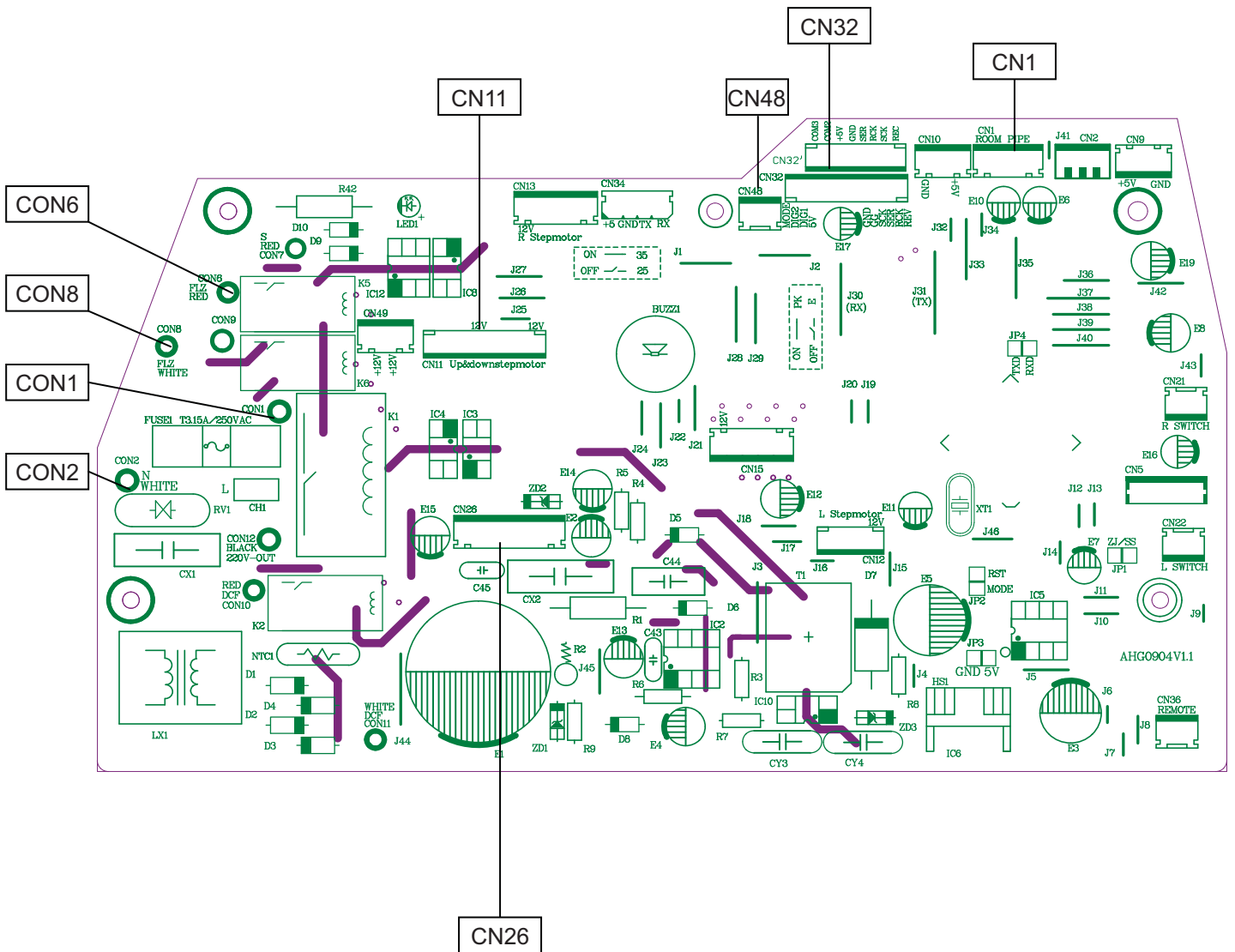

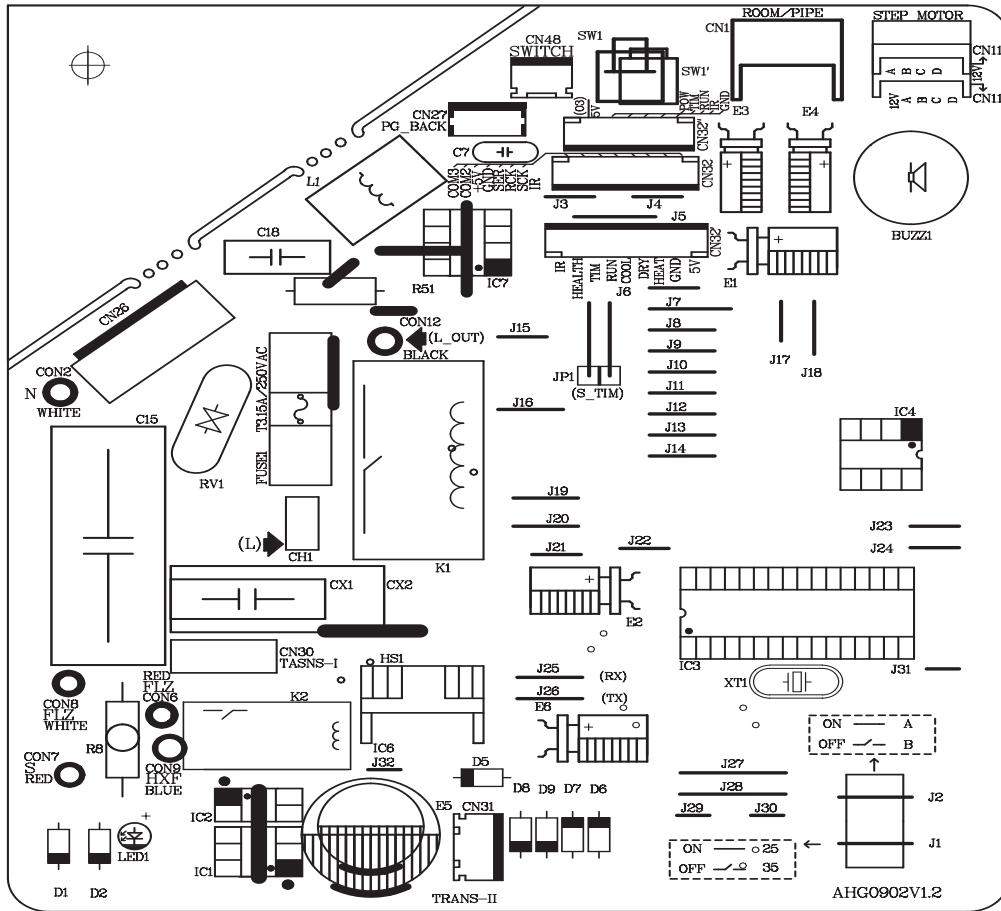

## 4.2 : outdoor unit

### Connectors

#### PCB(1) (Control PCB)

- 1) CN1,CN2 Connector for power N and L
- 2) CN3 Connector for ground
- 3) CN22 Connector for DC POWER 15V and 5V to the module board
- 4) CN16 Connector for electric expansion valves
- 5) CN21 Connector for DC fan motor
- 6) CN10 Connector for four way valve coil
- 7) CN17,CN18,CN19,CN20 Connector for thermistors  
(CN20: outdoor air,CN19: heat exchanger, CN18 :SUCK thermistors ,CN17 :discharge pipe)
- 8) CN23 Connector for communicate between the control board and the module board
- 9) CN25 ,CN8 Connector for the L,N to the module board
- 10) CN4 Connector for communicate between the indoor board and the outdoor board
- 11) CN26 Connector for capacitance anode
- 12) CN24 Connector for capacitance cathode

#### PCB(2) (module PCB)

- CN10 Connector for the DC power 5V and 15V form the control PCB
- CN11 Connector for communicate between the control board and the module board
- P( CN1), N(CN5) Connector for capacitance board
- LI (CN7),LO(CN6) Connector for reactor
- CN2, CN3, CN4 Connector for the U, V, W wire of the compressor

#### **Note:** Other Designations

##### PCB(1) (Control PCB)

- 1) FUSE 1, (25A,250VAC) FUSE 2(1A,250VAC)
- 2)LED 1 keep light representative normal ,if keep flash interval representative trouble Alarm
- 3)RV1,RV2,RV3 Varistor





PCB(2)

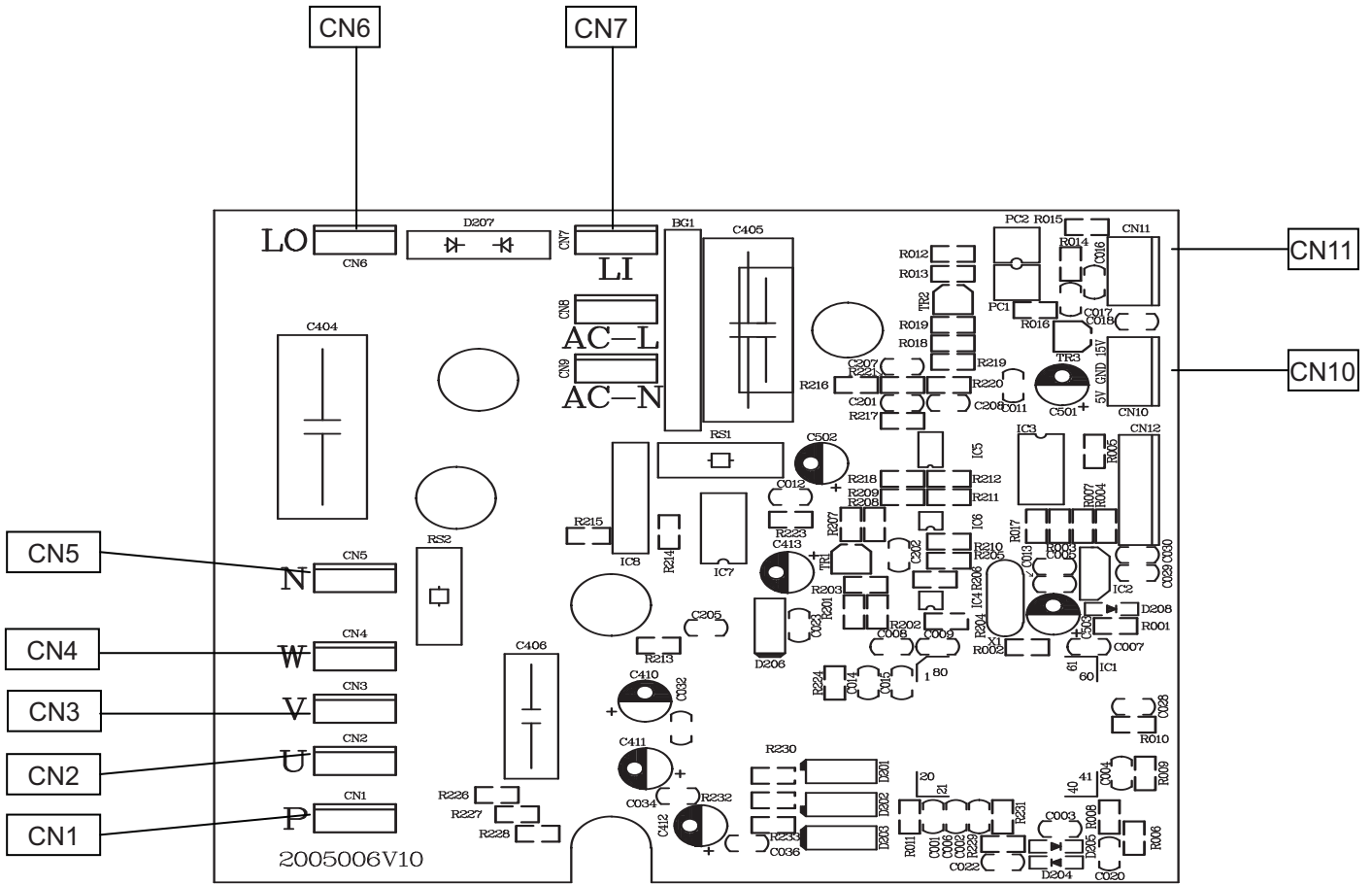

# 5.Functions and Control

## 5.1 Main functions and control specification of indoor unit

This specification use for HSU18VHJ (DB) frequency conversion air condition are manufactured by Haier air condition parent company. "Setting value" (express in parameter) in this specification means is a parameter that is stored in EEPROM. Refer to [EEPROM parameter table].

### 5.1.1 Temperature Adjusting function

#### 5.1.1.1 Temperature adjusting of different levels.

(DASH operation conditions under different modes)

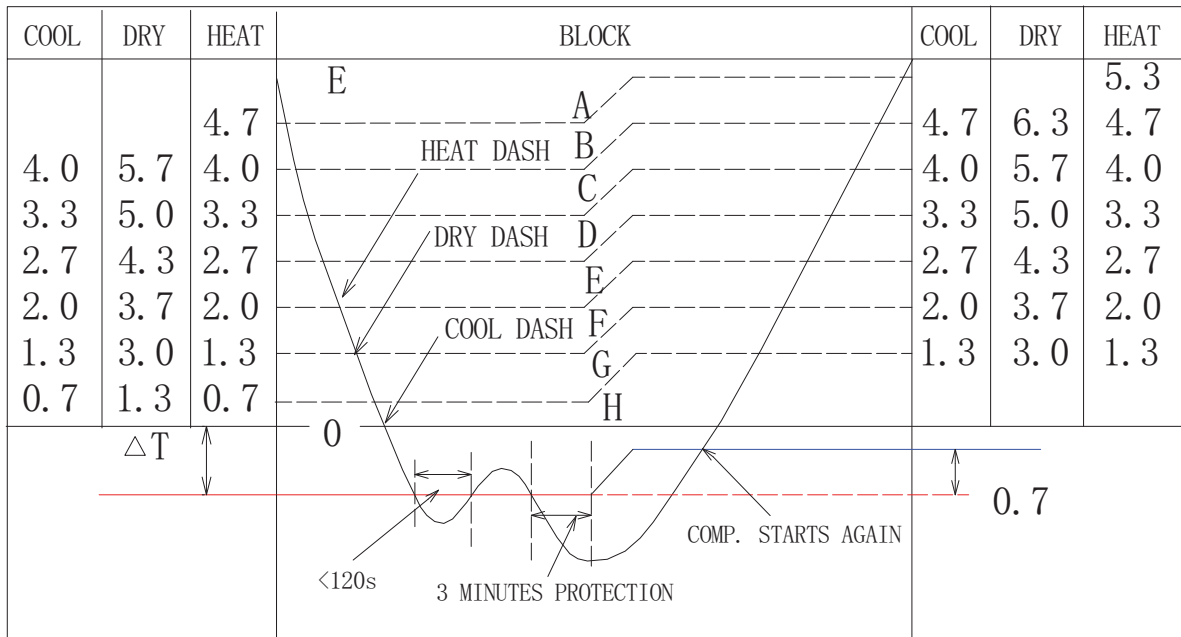

#### 5.1.1.2 Select the wind volume when it is set automatic

When the wind volume is automatic, it can be switched between strong, medium and weak according to the temperature adjusting levels.

Wind volume under the automatic wind volume mode

	Temperature adjusting levels								
	A	B	C	D	E	F	G	H	I
Heating	Strong	Strong	Strong	Strong	Strong	Medium	Weak	Weak	SLO
cooling		Strong	Strong	Strong	Medium	Medium	Weak	Weak	Weak
Moisture removing		Strong	Medium	Medium	Medium	Weak	Weak	SLO	SLO

**5.1.1.3 Wind volume limit**

When the compressor is working and the max setting for indoor fan motor is medium or weak, the upper limit of indicated frequency is as follows:

Frequency control form for wind volume

	Limited frequency variables	Limited frequency
Medium wind volume	FQLIMMD	70Hz
Weak wind volume	FQLIMLO	58Hz
Limited frequency for up/down health wind	FUPHEAL	48Hz

**5.1.2 Main functions**

**5.1.2.1 Warm boot**

When the heat running starts or the frost removing ends and the compressor starts again, in order to avoid cold wind, warm boot wind volume control should be done.

Heat exchange temperature

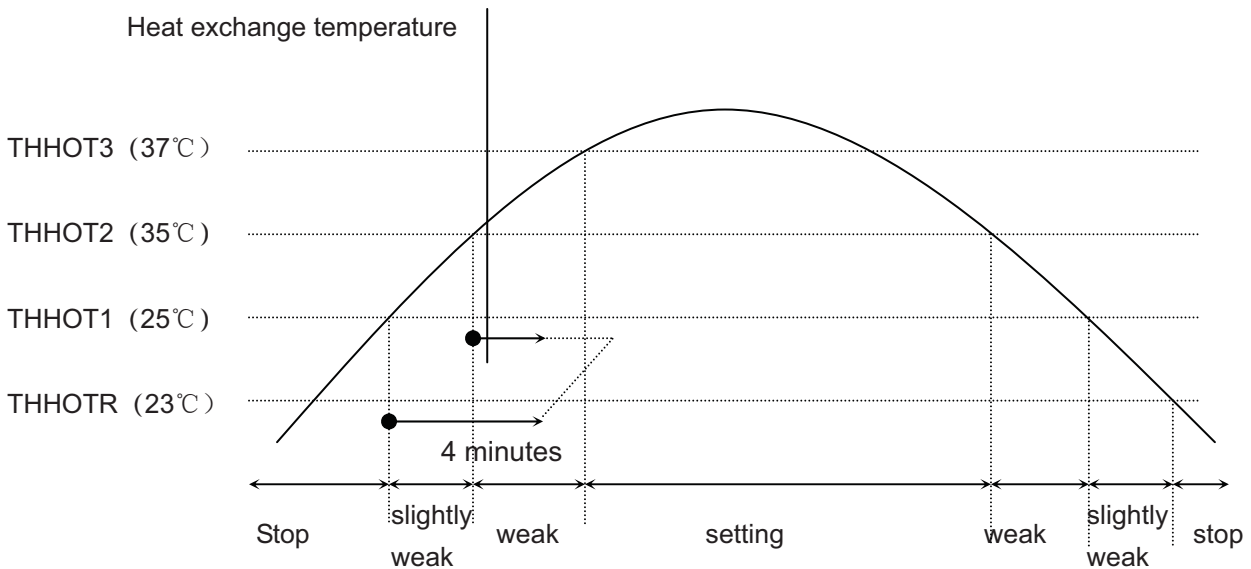

To control the indoor fan motor as shown in the table above according to the heat exchange temperature

The fan motor stops when the heat exchange temperature is below 25°C

The fan motor is working slightly weak when the heat exchange temperature is above 25 °C and below 35°C

The fan motor is working weak when the heat exchange temperature is above 35 °C and below 37°C

The fan motor works as set if the he heat exchange temperature remains above 38°C

### 5.1.2.2 When the compressor stops and remains idle for 3 minutes

20 seconds after the compressor stops, the up wind volume is weak (switching to SSLO in silent running mode) and then slightly weak. While the down wind volume is stopped  
If the compressor stops when the heat running starts, the wind volume is weak

### 5.1.2.3 Dehumidification running

Under the dehumidification mode the fan motor stops as the compressor stops

The operation is weak after 3 minutes' idle mode

After stand by for 3 minutes, the compressor is on.

The compressor operates as the set wind volume when the wind volume is set to be strong, medium or weak

The wind volume is decided according to the temperature adjusting when the wind volume is set to be automatic.

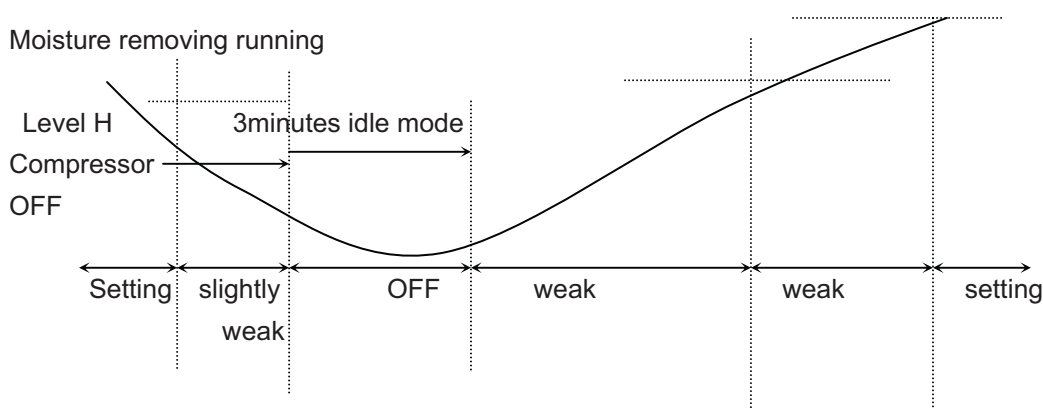

### 5.1.2.4 Automatic running

When the running mode is turned to automation after starting the system, the system will first determine the running mode according to the current room temperature and then will run according to the determined mode. Tr in the following selection conditions means room temperature, Ts means setting temperature, Tp means temperature of indoor coil pipe

$Tr \geq 23^{\circ}\text{C}$  Choose Cooling Mode

$Tr < 23^{\circ}\text{C}$  Choose Heating Mode

After turning to the automation mode, the running mode can be switched between cooling mode, fan mode and heating mode according to the change of the indoor ambient temperature. But the automatic conversion between cooling mode and heating mode must be conducted after 15 minutes.

## 5.1.3 Special functions

### 5.1.3.1 Powerful running

Powerful running for 15 minutes

The running stops or ends the powerful running after 15 minutes

The mode switch ends the powerful running

Enter into the silent mode, normal running mode or timed switching on mode to end the powerful running

When in automatic mode, there are powerful and silent functions for your choice. When the main unit is in cooling mode, it operates with powerful cooling or silent cooling. When the main unit is in heating mode, it operates with powerful heating or silent heating. When the main unit is in wind-sending mode, there are no powerful or silent modes.

There is no powerful mode for wind-sending and moisture removing

**Powerful heating:**

Change the set temperature. With temperature adjusting function

The wind volume is the automatic medium

When in frost removing mode, the outdoor unit does not accept the communication signal for powerful running

After 15 minutes of powerful running, the compressor can not be off within 10 minutes

**Powerful cooling:**

Change the set temperature. With temperature adjusting function

The wind volume is the automatic strong

After the compressor starts, there will be no low-intense running protection within 3 minutes

### 5.1.3.2 Silent running

Send the silent running signal to the outdoor unit

Under the Silent heating mode, The wind volume is SSLO after the compressor is on, The wind volume will be kept SSLO within 20 seconds after the compressor stops and then changes to weak

Under the Silent cooling mode the wind volume is SSLO

There is no silent mode for moisture removing and wind-sending.

### 5.1.3.3 Air cleaning

If the fan motor starts working after receiving the remote-control order, the aion generator starts working and sends out ions.

The ion generator stops as the fan motor stops.

When the ion generator is OFF and the air cleaning function is on, the fan motor starts running and the ion generator starts working again.

### 5.1.3.4 Timed running

Set the time duration according to the time difference between the clock for timing and the current clock

In timing mode, the display panel will flash the light at fixed times

<b>Timed OFF</b>	When this function is set, operation modes on the panel display will not change. The timing icon will show and the operation stops when the set time comes.
<b>Timed ON</b>	When this function is on, the panel display will only display a question mark. The unit will operate as the set mode when the time comes.
<b>Timed ON/OFF</b>	The unit will start operating or stop according to the order of your setting.

### 5.1.3.5 Sleeping function

a. After setting the sleeping function, the refrigerating mode and dehumidification mode will run as per the following rules:

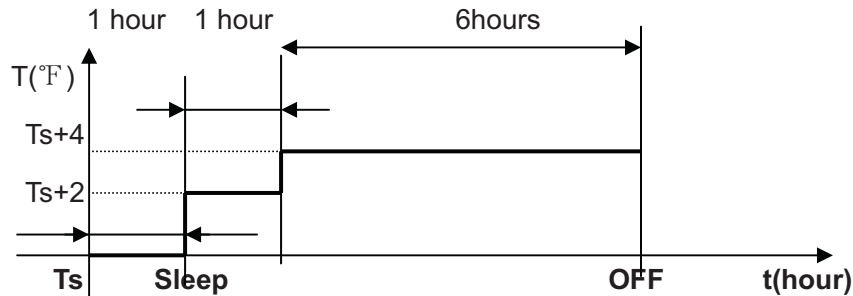

b. After setting the sleeping function, the heating mode will run as per the following rules:

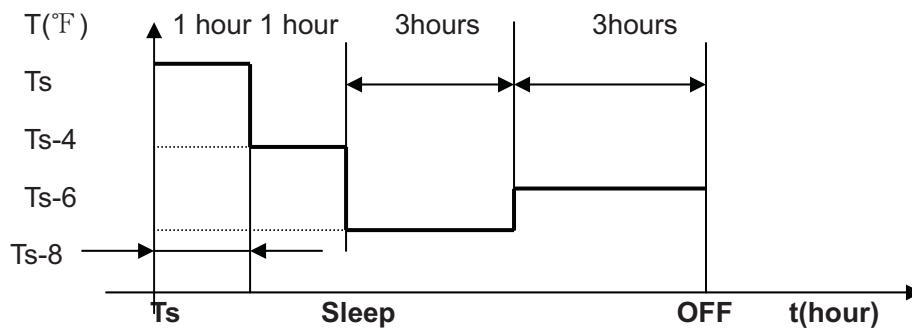

As shown in the above diagram, after running for 1 hour under refrigerating mode and dehumidification mode, the setting temperature will increase about  $2^{\circ}\text{F}$ ; after another 1 hour, it will increase about  $2^{\circ}\text{F}$  again, and after 6 hours, it will cease; after running for 1 hour under heating mode, the setting temperature will decrease about  $4^{\circ}\text{F}$ , after another 1 hour, it will decrease the about  $4^{\circ}\text{F}$  again, and after 3 hours, it will increase about  $2^{\circ}\text{C}$ , and after other 3 hours, it will cease.

### 5.1.3.6 Trial running

The indicated frequency for trial running is 58Hz, wind volume is strong.

The trial running will last for 30 minutes and then the unit will be powered off. The unit will exit the trial running if it receives any remote-control signal during the trial running period.

There is no low-intense running protection.

### 5.1.3.7 Power failure compensation

To enter into the function please press the sleep key 10 times with 4 beeps in 7 seconds

Under the power failure compensation mode, unplug and plug again ,the indoor unit will resume original operation

Under the power failure compensation mode, unplug and plug again, the unit will be on OFF state.

Mode, Fan speed, Healthy, Set temperature can be memoried. Swing, Timer, Sleep cannot be memoried

Press the sleep key for 10 times with 2 beeps in 7 seconds to exit.

---

### 5.1.3.8 Rated Operation

Rated Cooling:

When receiving the instruction of indoor unit rated operation, the unit will start rated cooling operation.

Rated Heating:

When receiving the instruction of indoor unit rated operation, the unit will start rated heating operation.

---

## 5.2 Main functions and control specification of outdoor unit

Sensor Code Definition: Tai= Indoor Ambient Temperature, Tao=Outdoor Ambient Temperature, Tc1=Indoor Coil, Td= Air Discharge, Te= Outdoor Coil, Ts=Air Intake

### 5.2.1 Outdoor Unit Operation Frequency and Control

#### Compressor Operation Frequency Range

Compressor Operation Frequency Range:

Outdoor Temperature	≤4	4~18	≥18
Heating (Hz)	20~110	20~90	20~53
Defrosting (Hz)	80		
Outdoor Temperature	≤23	23~32	≥32
Cooling (Hz)	20~50	20~70	20~95

#### Compressor Startup

Regardless of target frequency of indoor unit, each time when compressor is from off to on, it must maintain 60Hz,90Hz for one minute (Frequency will be immediately decreased under the condition that outdoor unit air discharge temperature overheating protection is activated or over current of compressor) then the compressor will operate towards target frequency. This process does not exist in normal operation of unit.

#### Heating

When completing compressor startup operation, it will operate as per frequency of indoor unit.  
After 2 minutes, compressor operation frequency will be compensated as per relevant conditions.

#### Cooling & Dehumidification:

When completing compressor startup operation, it will operate as per frequency of indoor unit.  
After 2 minutes, compressor operation frequency will be compensated as per relevant conditions.

#### Compressor Frequency Increase/Decrease Speed

Rapid Frequency Increase/Decrease Speed 1 -----1Hz/s  
Slow Frequency Increase/Decrease Speed 2 -----1Hz/10s



## 5.2.2 Outdoor fan control

**Compressor startup within 3min ,outdoor fan speed control as follows:**

Outdoor Temperature	<10	10~25	≥25
Cooling/ Dehumidification	1	3	7
Heating	5	3	2

**After compressor runs 3min ,outdoor fan speed control as follows:**

Cooling/ Dehumidification:

Compressor Operation Frequency (Hz)		<25	25~45	≥45
Tao (°C)	32 ~ 38	3	4	7
	23~32	1	2	5
	<23			
	≥38	7		

Heating:

Compressor Operation Frequency (Hz)		<25	25~45	≥45
Tao (°C)	≤4	3	4	7
	4~18	2	4	7
	≥18	1		

### Compressor shutdown and outdoor fan residual heat blow process

When compressor shuts down in cooling mode, outdoor fan automatically jumps to low speed and blows residual heat for 30s and stop.

## 5.2.3 Four-way Valve Control

Defrosting Four-way Valve Control, (please see defrosting process for details)

Time sequence of the defrosting operation is as follows:

Four-way Valve Work Status in Other Modes:

In heating mode, four-way valve is on. If compressor is off or is switched to non-heating mode, four-way valve ensures that it is off at least 2 minutes after compressor shuts down.

## 5.2.4 Outdoor Defrosting Control

### Defrosting Mode Entry Conditions

The unit will enter defrosting mode when compressor starts up and operates for 10 minutes continuously in heating mode or after compressor runs for an accumulated time of 45 minutes (Upon completion of defrosting or when switched to cooling mode, compressor accumulated operation time will be cleared) and when 2 minutes' continuous checking by defrosting sensor TE (check frosting condition of outdoor unit heat exchanger) and outdoor ambient temperature sensor TA meets the following conditions:

$$TE \leq C \times TA - \alpha$$

Among which:  $C: TA < 0^\circ\text{C}$ ,  $C=0.8$

$$TA \geq 0^\circ\text{C}, C=0.6$$

For area prone to frost, the value is set at 6 when unit leaves the factory.

Defrosting entry temperature control  $-15^\circ\text{C} \leq C \times TA - \alpha \leq -5^\circ\text{C}$

---

### Defrosting Time Interval

time interval between two defrosting cycles is 45 minutes.

### Defrosting Operation

When defrosting begins, compressor will stop for one minute, external fan is running and 50s later, four-way valve will be off.

When compressor starts, external fan will be off, compressor will run at 58Hz for 60s then move on to target frequency of 88Hz.

During defrosting, compressor current and air discharge overheat protection features are effective. During defrosting, if compressor shuts down due to activation of protection feature or due to malfunction, it will resume after 3 minutes. In the unit is still within defrosting cycle, it will resume defrosting and startup of compressor will be based on the rule for defrosting startup. (The unit will exit defrosting mode and handle fault in the event of 3 consecutive restart failures.)

On entering defrosting, it must guarantee that compressor will operate for a minimum of 2 minutes in defrosting mode before exit.

---

### Defrosting Exit Condition

When one of the following conditions is met, defrosting operation will be switched to heating operation.

- (1) : Temperature of outdoor heat exchanger exceeds  $7^\circ\text{C}$  for 80s continuously
  - (2) : Temperature of outdoor heat exchanger exceeds  $12^\circ\text{C}$  for 5s continuously
  - (3) : Defrosting operation continues for 11 minutes.
- 

### When defrosting exit conditions are met, the unit will operate as follows

Compressor stops and external fan starts, 50s later, four-way valve will be on, 60s later, compressor will operate as per startup process.

---

## 5.2.5 PTC Output Control

When outdoor unit is energized, PTC output value is 0, 10s later, output value is 1.

When compressor stops for 10 minutes continuously, PTC output value is 0.

On receiving compressor startup instruction, initial PTC output is 1, and compressor startup will be performed 5s later.

---

## 5.2.6 System Protection Function

### 5.2.6.1 3 minutes stand-by time

Time interval between compressor shutdown and restart is set at 3 minutes to ensure that compressor will only restart after 3-minute shutdown and initial energization valves are turned on to adequate opening position after being fully turned off.

### 5.2.6.2 TD High Temperature Protections

As long as unit is on, the TD air discharge overheat protection feature will be activated, yet air discharge sensor fault must be alarmed 4 minutes after compressor starts.

TD (°C)

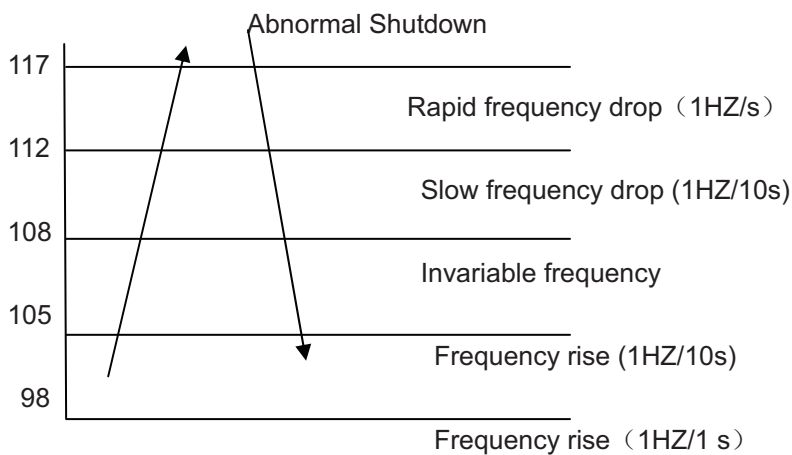

When  $TD > 117^{\circ}\text{C}$  for 20s continuously, air discharge overheat protection will be activated and fault will be reported to indoor unit.

It will not continue in other conditions.

### 5.2.6.3 Indoor Heat Exchanger Anti-freeze Protection

#### Anti-freeze during cooling

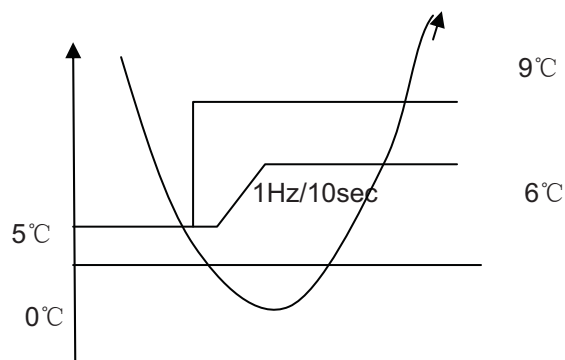

When  $TC < 5^{\circ}\text{C}$ , compressor frequency will drop at a speed of 1HZ/10s

When TC starts to rise, and  $6 \leq TC \leq 9^{\circ}\text{C}$ , compressor frequency will remain unchanged.

When  $9 < TC < 11^{\circ}\text{C}$ , frequency will rise normal.

If  $TC \leq 0^{\circ}\text{C}$ , for 2 consecutive minutes, compressor will shutdown and outdoor fault lamp blinks. Fault will not be reported to indoor unit.

When compressor shuts down for more than 3 minutes, and when  $TC > 9^{\circ}\text{C}$ , compressor will restart.

#### 5.2.6.4 Outdoor Temperature Limit

Cooling: When outdoor temperature is lower than 23°C, cooling operation will start, compressor frequency is limited to less than 50 HZ, outdoor wind speed is forced at level 1.

Heating: When outdoor temperature is higher than 18°C, heating operation will start, compressor frequency is limited to less than 53 HZ, outdoor wind speed is forced at level 1.

---

#### 5.2.6.5 Special Features

1. Forced Cooling: When receiving indoor forced cooling signal, cooling operation will start in a frequency signaled by indoor unit. Only air discharge temperature and over current protection features are effective and other protection features are invalid.

2. Rated, Middle and Minimum Capacity Operation: When receiving indoor, rated, middle and minimum capacity operation signal, outdoor unit will operate as per wind speed and frequency set by EEPROM and all the protection features are effective.

---

#### 5.2.6.6 Fault Display and Treatment

In case outdoor unit faults, the alarm indicator lamp will blink and blink frequency is 1HZ, Time interval between blink cycles is 3s.

Alarm indicator lamp is off when there is no fault.

## 5.3 Function of Main Thermistor

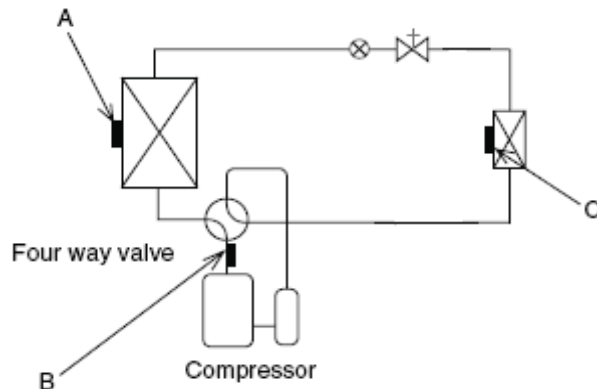

**Note:** A: Outdoor suction temperature sensor

B: Exhaust temperature sensor

C: Indoor heat-exchange sensor

### Outdoor Suction Temperature Sensor

The outdoor heat exchanger thermistor is used for controlling target discharge temperature.

The system sets a target discharge temperature according to the outdoor and indoor heat exchanger temperature, and controls the electronic expansion valve opening so that the target discharge temperature can be obtained.

### Exhaust Temperature Sensor

The discharge pipe thermistor is used for controlling temperature of the discharge pipe.

If the temperature of discharge pipe (used in place of the inner temperature of the compressor) rises abnormally, the operating frequency drops or the operation halts.

### Indoor heat-exchange sensor

1. The indoor heat exchanger thermistor is used for controlling target discharge temperature.

The system sets a target discharge temperature according to the outdoor and indoor heat exchanger temperature, and controls the electronic expansion valve opening so that the target discharge temperature can be obtained.

2. The indoor heat exchanger thermistor is used for preventing freezing. During the cooling operation, if the temperature drops abnormally, the operating frequency becomes lower, then the operation halts.

3. The indoor heat exchanger thermistor is used for anti-icing control. During the cooling operation, if the heat exchanger temperature in the room where operation is halted becomes  $-1^{\circ}\text{C}$ , it is assumed as icing.

## 5.4 Value of Thermistor

### 5.4.1 indoor Unit

#### Room sensor

$R_{25^{\circ}\text{C}}=23\text{K}\Omega\pm 3.5\%$

$B_{25^{\circ}\text{C}/50^{\circ}\text{C}}=4200\text{K}\pm 3\%$

Temp.( $^{\circ}\text{C}$ )	Max.( $\text{K}\Omega$ )	Normal( $\text{K}\Omega$ )	Min.( $\text{K}\Omega$ )	Tolerance( $^{\circ}\text{C}$ )	
-30	568.8372	501.0746	440.8435	-1.97	1.75
-29	530.9600	468.6491	413.1441	-1.95	1.74
-28	495.8488	438.5314	387.3645	-1.93	1.72
-27	463.2850	410.5433	363.3602	-1.91	1.71
-26	433.0683	384.5212	340.9980	-1.90	1.70
-25	405.0156	360.3153	320.1558	-1.88	1.69
-24	378.9588	337.7879	300.7211	-1.86	1.67
-23	354.7440	316.8126	282.5905	-1.84	1.66
-22	332.2300	297.2732	265.6686	-1.82	1.64
-21	311.2873	279.0627	249.8676	-1.80	1.63
-20	291.7969	262.0831	235.1067	-1.78	1.62
-19	273.6494	246.2437	221.3111	-1.76	1.60
-18	256.7445	231.4612	208.4122	-1.74	1.59
-17	240.9897	217.6590	196.3462	-1.72	1.57
-16	226.3000	204.7662	185.0545	-1.70	1.56
-15	212.5973	192.7176	174.4829	-1.68	1.54
-14	199.8093	181.4531	164.5813	-1.66	1.53
-13	187.8698	170.9169	155.3033	-1.64	1.51
-12	176.7176	161.0578	146.6059	-1.62	1.49
-11	166.2961	151.8284	138.4495	-1.60	1.48
-10	156.5532	143.1847	130.7973	-1.58	1.46
-9	147.4409	135.0863	123.6153	-1.56	1.44
-8	138.9148	127.4956	116.8717	-1.53	1.43
-7	130.9337	120.3778	110.5374	-1.51	1.41
-6	123.4597	113.7009	104.5852	-1.49	1.39
-5	116.4577	107.4349	98.9897	-1.47	1.38
-4	109.8953	101.5523	93.7278	-1.45	1.36
-3	103.7422	96.0274	88.7774	-1.43	1.34
-2	97.9708	90.8365	84.1185	-1.40	1.32
-1	92.5551	85.9574	79.7322	-1.38	1.30
0	87.4712	81.3697	75.6011	-1.36	1.29
1	82.6970	77.0544	71.7088	-1.34	1.27
2	78.2118	72.9937	68.0402	-1.31	1.25
3	73.9966	69.1712	64.5813	-1.29	1.23
4	70.0335	65.5716	61.3188	-1.27	1.21
5	66.3062	62.1807	58.2405	-1.24	1.19

6	62.7992	58.9853	55.3351	-1.22	1.17
7	59.4984	55.9729	52.5917	-1.20	1.15
8	56.3905	53.1320	50.0006	-1.17	1.13
9	53.4631	50.4521	47.5523	-1.15	1.11
10	50.7048	47.9230	45.2384	-1.13	1.09
11	48.1049	45.5355	43.0505	-1.10	1.07
12	45.6534	43.2808	40.9813	-1.08	1.04
13	43.3410	41.1509	39.0236	-1.05	1.02
14	41.1592	39.1381	37.1708	-1.03	1.00
15	39.0998	37.2355	35.4167	-1.00	0.98
16	37.1553	35.4363	33.7555	-0.98	0.96
17	35.3186	33.7344	32.1818	-0.95	0.94
18	33.5833	32.1240	30.6905	-0.93	0.91
19	31.9432	30.5997	29.2769	-0.90	0.89
20	30.3925	29.1565	27.9365	-0.88	0.87
21	28.9259	27.7895	26.6651	-0.85	0.84
22	27.5383	26.4944	25.4589	-0.83	0.82
23	26.2252	25.2670	24.3140	-0.80	0.80
24	24.9822	24.1034	23.2271	-0.78	0.77
25	23.8050	23.0000	22.1950	-0.78	0.77
26	22.7500	21.9499	21.1520	-0.78	0.78
27	21.7477	20.9536	20.1638	-0.82	0.81
28	20.7951	20.0081	19.2272	-0.86	0.85
29	19.8895	19.1104	18.3394	-0.89	0.88
30	19.0285	18.2581	17.4974	-0.93	0.92
31	18.2094	17.4484	16.6988	-0.97	0.95
32	17.4302	16.6792	15.9410	-1.00	0.99
33	16.6885	15.9480	15.2217	-1.04	1.02
34	15.9825	15.2530	14.5389	-1.08	1.06
35	15.3103	14.5920	13.8903	-1.12	1.09
36	14.6700	13.9632	13.2743	-1.16	1.13
37	14.0599	13.3650	12.6889	-1.20	1.16
38	13.4786	12.7957	12.1325	-1.23	1.20
39	12.9244	12.2537	11.6035	-1.27	1.24
40	12.3960	11.7375	11.1004	-1.31	1.27
41	11.8921	11.2459	10.6218	-1.35	1.31
42	11.4113	10.7775	10.1665	-1.39	1.34
43	10.9526	10.3311	9.7330	-1.43	1.38
44	10.5147	9.9056	9.3204	-1.48	1.42
45	10.0967	9.4999	8.9275	-1.52	1.45
46	9.6976	9.1130	8.5532	-1.56	1.49
47	9.3163	8.7439	8.1965	-1.60	1.53
48	8.9521	8.3916	7.8566	-1.64	1.57
49	8.6040	8.0554	7.5327	-1.68	1.60

50	8.2713	7.7345	7.2237	-1.73	1.64
51	7.9531	7.4280	6.9291	-1.77	1.68
52	7.6489	7.1353	6.6480	-1.81	1.72
53	7.3580	6.8556	6.3797	-1.85	1.76
54	7.0796	6.5884	6.1237	-1.90	1.79
55	6.8131	6.3329	5.8793	-1.94	1.83
56	6.5581	6.0887	5.6459	-1.99	1.87
57	6.3140	5.8552	5.4230	-2.03	1.91
58	6.0802	5.6318	5.2100	-2.07	1.95
59	5.8563	5.4181	5.0065	-2.12	1.99
60	5.6417	5.2136	4.8120	-2.16	2.03
61	5.4361	5.0178	4.6260	-2.21	2.07
62	5.2391	4.8304	4.4481	-2.25	2.11
63	5.0502	4.6510	4.2780	-2.30	2.15
64	4.8691	4.4791	4.1153	-2.35	2.19
65	4.6954	4.3145	3.9596	-2.39	2.23
66	4.5287	4.1567	3.8105	-2.44	2.27
67	4.3689	4.0055	3.6678	-2.49	2.31
68	4.2154	3.8605	3.5312	-2.53	2.35
69	4.0682	3.7216	3.4004	-2.58	2.39
70	3.9268	3.5883	3.2750	-2.63	2.43
71	3.7910	3.4605	3.1549	-2.68	2.48
72	3.6606	3.3378	3.0398	-2.73	2.52
73	3.5353	3.2201	2.9294	-2.77	2.56
74	3.4150	3.1072	2.8237	-2.82	2.60
75	3.2993	2.9987	2.7222	-2.87	2.64
76	3.1881	2.8946	2.6249	-2.92	2.68
77	3.0812	2.7946	2.5316	-2.97	2.73
78	2.9785	2.6986	2.4420	-3.02	2.77
79	2.8796	2.6063	2.3560	-3.07	2.81
80	2.7845	2.5176	2.2735	-3.12	2.86
81	2.6931	2.4324	2.1943	-3.17	2.90
82	2.6050	2.3505	2.1182	-3.22	2.94
83	2.5203	2.2717	2.0451	-3.28	2.99
84	2.4388	2.1960	1.9749	-3.33	3.03
85	2.3602	2.1231	1.9075	-3.38	3.07
86	2.2846	2.0530	1.8426	-3.43	3.12
87	2.2118	1.9856	1.7803	-3.48	3.16
88	2.1416	1.9207	1.7204	-3.54	3.20
89	2.0740	1.8582	1.6628	-3.59	3.25
90	2.0089	1.7981	1.6074	-3.64	3.29
91	1.9461	1.7402	1.5541	-3.70	3.34



92	1.8856	1.6844	1.5028	-3.75	3.38
93	1.8272	1.6307	1.4535	-3.80	3.43
94	1.7709	1.5789	1.4060	-3.86	3.47
95	1.7166	1.5291	1.3603	-3.91	3.52
96	1.6643	1.4810	1.3163	-3.97	3.56
97	1.6138	1.4347	1.2739	-4.02	3.61
98	1.5650	1.3900	1.2331	-4.08	3.66
99	1.5180	1.3470	1.1937	-4.13	3.70
100	1.4726	1.3054	1.1559	-4.19	3.75
101	1.4287	1.2654	1.1194	-4.24	3.80
102	1.3864	1.2268	1.0842	-4.30	3.84
103	1.3455	1.1895	1.0503	-4.36	3.89
104	1.3060	1.1535	1.0176	-4.42	3.94
105	1.2679	1.1188	0.9860	-4.47	3.98
106	1.2310	1.0853	0.9556	-4.53	4.03
107	1.1954	1.0529	0.9263	-4.59	4.08
108	1.1610	1.0217	0.8980	-4.65	4.13
109	1.1277	0.9915	0.8707	-4.70	4.17
110	1.0955	0.9624	0.8443	-4.76	4.22
111	1.0644	0.9342	0.8189	-4.82	4.27
112	1.0344	0.9070	0.7943	-4.88	4.32
113	1.0053	0.8807	0.7706	-4.94	4.37
114	0.9771	0.8553	0.7478	-5.00	4.41
115	0.9499	0.8307	0.7256	-5.06	4.46
116	0.9235	0.8070	0.7043	-5.12	4.51
117	0.8980	0.7840	0.6837	-5.18	4.56
118	0.8734	0.7618	0.6637	-5.24	4.61
119	0.8495	0.7404	0.6445	-5.30	4.66
120	0.8263	0.7196	0.6258	-5.36	4.71

## Pipe Sensor

R25°C=10KΩ±3%

B25°C/50°C=3700K±3%

Temp.((°C))	Max.(KΩ)	Normal(KΩ)	Min.(KΩ)	Tolerance(°C)	
-30	165.2170	147.9497	132.3678	-1.94	1.75
-29	155.5754	139.5600	125.0806	-1.93	1.74
-28	146.5609	131.7022	118.2434	-1.91	1.73
-27	138.1285	124.3392	111.8256	-1.89	1.71
-26	130.2371	117.4366	105.7989	-1.87	1.70
-25	122.8484	110.9627	100.1367	-1.85	1.69
-24	115.9272	104.8882	94.8149	-1.83	1.67
-23	109.4410	99.1858	89.8106	-1.81	1.66
-22	103.3598	93.8305	85.1031	-1.80	1.64

-21	97.6556	88.7989	80.6728	-1.78	1.63
-20	92.3028	84.0695	76.5017	-1.76	1.62
-19	87.2775	79.6222	72.5729	-1.74	1.60
-18	82.5577	75.4384	68.8710	-1.72	1.59
-17	78.1230	71.5010	65.3815	-1.70	1.57
-16	73.9543	67.7939	62.0907	-1.68	1.55
-15	70.0342	64.3023	58.9863	-1.66	1.54
-14	66.3463	61.0123	56.0565	-1.64	1.52
-13	62.8755	57.9110	53.2905	-1.62	1.51
-12	59.6076	54.9866	50.6781	-1.60	1.49
-11	56.5296	52.2278	48.2099	-1.58	1.47
-10	53.6294	49.6244	45.8771	-1.56	1.46
-9	50.8956	47.1666	43.6714	-1.54	1.44
-8	48.3178	44.8454	41.5851	-1.51	1.42
-7	45.8860	42.6525	39.6112	-1.49	1.40
-6	43.5912	40.5800	37.7429	-1.47	1.39
-5	41.4249	38.6207	35.9739	-1.45	1.37
-4	39.3792	36.7676	34.2983	-1.43	1.35
-3	37.4465	35.0144	32.7108	-1.41	1.33
-2	35.6202	33.3552	31.2062	-1.38	1.31
-1	33.8936	31.7844	29.7796	-1.36	1.29
0	32.2608	30.2968	28.4267	-1.34	1.28
1	30.7162	28.8875	27.1431	-1.32	1.26
2	29.2545	27.5519	25.9250	-1.29	1.24
3	27.8708	26.2858	24.7686	-1.27	1.22
4	26.5605	25.0851	23.6704	-1.25	1.20
5	25.3193	23.9462	22.6273	-1.23	1.18
6	24.1432	22.8656	21.6361	-1.20	1.16
7	23.0284	21.8398	20.6939	-1.18	1.14
8	21.9714	20.8659	19.7982	-1.15	1.12
9	20.9688	19.9409	18.9463	-1.13	1.09
10	20.0176	19.0621	18.1358	-1.11	1.07
11	19.1149	18.2270	17.3646	-1.08	1.05
12	18.2580	17.4331	16.6305	-1.06	1.03
13	17.4442	16.6782	15.9315	-1.03	1.01
14	16.6711	15.9601	15.2657	-1.01	0.99
15	15.9366	15.2770	14.6315	-0.98	0.96
16	15.2385	14.6268	14.0271	-0.96	0.94
17	14.5748	14.0079	13.4510	-0.93	0.92
18	13.9436	13.4185	12.9017	-0.91	0.90
19	13.3431	12.8572	12.3778	-0.88	0.87
20	12.7718	12.3223	11.8780	-0.86	0.85
21	12.2280	11.8126	11.4011	-0.83	0.83
22	11.7102	11.3267	10.9459	-0.81	0.80

23	11.2172	10.8634	10.5114	-0.78	0.78
24	10.7475	10.4216	10.0964	-0.75	0.75
25	10.3000	10.0000	9.7000	-0.75	0.75
26	9.8975	9.5974	9.2980	-0.76	0.76
27	9.5129	9.2132	8.9148	-0.80	0.80
28	9.1454	8.8465	8.5496	-0.84	0.83
29	8.7942	8.4964	8.2013	-0.87	0.86
30	8.4583	8.1621	7.8691	-0.91	0.90
31	8.1371	7.8428	7.5522	-0.95	0.93
32	7.8299	7.5377	7.2498	-0.98	0.97
33	7.5359	7.2461	6.9611	-1.02	1.00
34	7.2546	6.9673	6.6854	-1.06	1.04
35	6.9852	6.7008	6.4222	-1.10	1.07
36	6.7273	6.4459	6.1707	-1.13	1.11
37	6.4803	6.2021	5.9304	-1.17	1.14
38	6.2437	5.9687	5.7007	-1.21	1.18
39	6.0170	5.7454	5.4812	-1.25	1.22
40	5.7997	5.5316	5.2712	-1.29	1.25
41	5.5914	5.3269	5.0704	-1.33	1.29
42	5.3916	5.1308	4.8783	-1.37	1.33
43	5.2001	4.9430	4.6944	-1.41	1.36
44	5.0163	4.7630	4.5185	-1.45	1.40
45	4.8400	4.5905	4.3500	-1.49	1.44
46	4.6708	4.4252	4.1887	-1.53	1.47
47	4.5083	4.2666	4.0342	-1.57	1.51
48	4.3524	4.1145	3.8862	-1.61	1.55
49	4.2026	3.9686	3.7443	-1.65	1.59
50	4.0588	3.8287	3.6084	-1.70	1.62
51	3.9206	3.6943	3.4780	-1.74	1.66
52	3.7878	3.5654	3.3531	-1.78	1.70
53	3.6601	3.4416	3.2332	-1.82	1.74
54	3.5374	3.3227	3.1183	-1.87	1.78
55	3.4195	3.2085	3.0079	-1.91	1.82
56	3.3060	3.0989	2.9021	-1.95	1.85
57	3.1969	2.9935	2.8005	-2.00	1.89
58	3.0919	2.8922	2.7029	-2.04	1.93
59	2.9909	2.7948	2.6092	-2.08	1.97
60	2.8936	2.7012	2.5193	-2.13	2.01
61	2.8000	2.6112	2.4328	-2.17	2.05
62	2.7099	2.5246	2.3498	-2.22	2.09
63	2.6232	2.4413	2.2700	-2.26	2.13
64	2.5396	2.3611	2.1932	-2.31	2.17
65	2.4591	2.2840	2.1195	-2.36	2.21
66	2.3815	2.2098	2.0486	-2.40	2.25

67	2.3068	2.1383	1.9803	-2.45	2.29
68	2.2347	2.0695	1.9147	-2.49	2.34
69	2.1652	2.0032	1.8516	-2.54	2.38
70	2.0983	1.9393	1.7908	-2.59	2.42
71	2.0337	1.8778	1.7324	-2.63	2.46
72	1.9714	1.8186	1.6761	-2.68	2.50
73	1.9113	1.7614	1.6219	-2.73	2.54
74	1.8533	1.7064	1.5697	-2.78	2.58
75	1.7974	1.6533	1.5194	-2.83	2.63
76	1.7434	1.6021	1.4710	-2.88	2.67
77	1.6913	1.5528	1.4243	-2.92	2.71
78	1.6409	1.5051	1.3794	-2.97	2.75
79	1.5923	1.4592	1.3360	-3.02	2.80
80	1.5454	1.4149	1.2942	-3.07	2.84
81	1.5000	1.3721	1.2540	-3.12	2.88
82	1.4562	1.3308	1.2151	-3.17	2.93
83	1.4139	1.2910	1.1776	-3.22	2.97
84	1.3730	1.2525	1.1415	-3.27	3.01
85	1.3335	1.2153	1.1066	-3.32	3.06
86	1.2953	1.1794	1.0730	-3.38	3.10
87	1.2583	1.1448	1.0405	-3.43	3.15
88	1.2226	1.1113	1.0092	-3.48	3.19
89	1.1880	1.0789	0.9789	-3.53	3.24
90	1.1546	1.0476	0.9497	-3.58	3.28
91	1.1223	1.0174	0.9215	-3.64	3.33
92	1.0910	0.9882	0.8942	-3.69	3.37
93	1.0607	0.9599	0.8679	-3.74	3.42
94	1.0314	0.9326	0.8424	-3.80	3.46
95	1.0030	0.9061	0.8179	-3.85	3.51
96	0.9756	0.8806	0.7941	-3.90	3.55
97	0.9490	0.8558	0.7711	-3.96	3.60
98	0.9232	0.8319	0.7489	-4.01	3.64
99	0.8983	0.8088	0.7275	-4.07	3.69
100	0.8741	0.7863	0.7067	-4.12	3.74
101	0.8507	0.7646	0.6867	-4.18	3.78
102	0.8281	0.7436	0.6672	-4.23	3.83
103	0.8061	0.7233	0.6484	-4.29	3.88
104	0.7848	0.7036	0.6303	-4.34	3.92
105	0.7641	0.6845	0.6127	-4.40	3.97
106	0.7441	0.6661	0.5957	-4.46	4.02
107	0.7247	0.6482	0.5792	-4.51	4.07
108	0.7059	0.6308	0.5632	-4.57	4.12
109	0.6877	0.6140	0.5478	-4.63	4.16
110	0.6700	0.5977	0.5328	-4.69	4.21

111	0.6528	0.5820	0.5183	-4.74	4.26
112	0.6361	0.5667	0.5043	-4.80	4.31
113	0.6200	0.5518	0.4907	-4.86	4.36
114	0.6043	0.5374	0.4775	-4.92	4.41
115	0.5891	0.5235	0.4648	-4.98	4.45
116	0.5743	0.5100	0.4524	-5.04	4.50
117	0.5600	0.4968	0.4404	-5.10	4.55
118	0.5460	0.4841	0.4288	-5.16	4.60
119	0.5325	0.4717	0.4175	-5.22	4.65
120	0.5194	0.4597	0.4066	-5.28	4.70

## 5.4.2 Outdoor Unit

### Ambient Sensor, Suction Sensor, Defrosting Sensor

R25°C=10KΩ±3%

B25°C/50°C=3700K±3%

Temp.(°C)	Max.(KΩ)	Normal(KΩ)	Min.(KΩ)	Tolerance(°C)	
-30	165.2170	147.9497	132.3678	-1.94	1.75
-29	155.5754	139.5600	125.0806	-1.93	1.74
-28	146.5609	131.7022	118.2434	-1.91	1.73
-27	138.1285	124.3392	111.8256	-1.89	1.71
-26	130.2371	117.4366	105.7989	-1.87	1.70
-25	122.8484	110.9627	100.1367	-1.85	1.69
-24	115.9272	104.8882	94.8149	-1.83	1.67
-23	109.4410	99.1858	89.8106	-1.81	1.66
-22	103.3598	93.8305	85.1031	-1.80	1.64
-21	97.6556	88.7989	80.6728	-1.78	1.63
-20	92.3028	84.0695	76.5017	-1.76	1.62
-19	87.2775	79.6222	72.5729	-1.74	1.60
-18	82.5577	75.4384	68.8710	-1.72	1.59
-17	78.1230	71.5010	65.3815	-1.70	1.57
-16	73.9543	67.7939	62.0907	-1.68	1.55
-15	70.0342	64.3023	58.9863	-1.66	1.54
-14	66.3463	61.0123	56.0565	-1.64	1.52
-13	62.8755	57.9110	53.2905	-1.62	1.51
-12	59.6076	54.9866	50.6781	-1.60	1.49
-11	56.5296	52.2278	48.2099	-1.58	1.47
-10	53.6294	49.6244	45.8771	-1.56	1.46
-9	50.8956	47.1666	43.6714	-1.54	1.44
-8	48.3178	44.8454	41.5851	-1.51	1.42
-7	45.8860	42.6525	39.6112	-1.49	1.40
-6	43.5912	40.5800	37.7429	-1.47	1.39
-5	41.4249	38.6207	35.9739	-1.45	1.37
-4	39.3792	36.7676	34.2983	-1.43	1.35

-3	37.4465	35.0144	32.7108	-1.41	1.33
-2	35.6202	33.3552	31.2062	-1.38	1.31
-1	33.8936	31.7844	29.7796	-1.36	1.29
0	32.2608	30.2968	28.4267	-1.34	1.28
1	30.7162	28.8875	27.1431	-1.32	1.26
2	29.2545	27.5519	25.9250	-1.29	1.24
3	27.8708	26.2858	24.7686	-1.27	1.22
4	26.5605	25.0851	23.6704	-1.25	1.20
5	25.3193	23.9462	22.6273	-1.23	1.18
6	24.1432	22.8656	21.6361	-1.20	1.16
7	23.0284	21.8398	20.6939	-1.18	1.14
8	21.9714	20.8659	19.7982	-1.15	1.12
9	20.9688	19.9409	18.9463	-1.13	1.09
10	20.0176	19.0621	18.1358	-1.11	1.07
11	19.1149	18.2270	17.3646	-1.08	1.05
12	18.2580	17.4331	16.6305	-1.06	1.03
13	17.4442	16.6782	15.9315	-1.03	1.01
14	16.6711	15.9601	15.2657	-1.01	0.99
15	15.9366	15.2770	14.6315	-0.98	0.96
16	15.2385	14.6268	14.0271	-0.96	0.94
17	14.5748	14.0079	13.4510	-0.93	0.92
18	13.9436	13.4185	12.9017	-0.91	0.90
19	13.3431	12.8572	12.3778	-0.88	0.87
20	12.7718	12.3223	11.8780	-0.86	0.85
21	12.2280	11.8126	11.4011	-0.83	0.83
22	11.7102	11.3267	10.9459	-0.81	0.80
23	11.2172	10.8634	10.5114	-0.78	0.78
24	10.7475	10.4216	10.0964	-0.75	0.75
25	10.3000	10.0000	9.7000	-0.75	0.75
26	9.8975	9.5974	9.2980	-0.76	0.76
27	9.5129	9.2132	8.9148	-0.80	0.80
28	9.1454	8.8465	8.5496	-0.84	0.83
29	8.7942	8.4964	8.2013	-0.87	0.86
30	8.4583	8.1621	7.8691	-0.91	0.90
31	8.1371	7.8428	7.5522	-0.95	0.93
32	7.8299	7.5377	7.2498	-0.98	0.97
33	7.5359	7.2461	6.9611	-1.02	1.00
34	7.2546	6.9673	6.6854	-1.06	1.04
35	6.9852	6.7008	6.4222	-1.10	1.07
36	6.7273	6.4459	6.1707	-1.13	1.11
37	6.4803	6.2021	5.9304	-1.17	1.14
38	6.2437	5.9687	5.7007	-1.21	1.18
39	6.0170	5.7454	5.4812	-1.25	1.22
40	5.7997	5.5316	5.2712	-1.29	1.25

41	5.5914	5.3269	5.0704	-1.33	1.29
42	5.3916	5.1308	4.8783	-1.37	1.33
43	5.2001	4.9430	4.6944	-1.41	1.36
44	5.0163	4.7630	4.5185	-1.45	1.40
45	4.8400	4.5905	4.3500	-1.49	1.44
46	4.6708	4.4252	4.1887	-1.53	1.47
47	4.5083	4.2666	4.0342	-1.57	1.51
48	4.3524	4.1145	3.8862	-1.61	1.55
49	4.2026	3.9686	3.7443	-1.65	1.59
50	4.0588	3.8287	3.6084	-1.70	1.62
51	3.9206	3.6943	3.4780	-1.74	1.66
52	3.7878	3.5654	3.3531	-1.78	1.70
53	3.6601	3.4416	3.2332	-1.82	1.74
54	3.5374	3.3227	3.1183	-1.87	1.78
55	3.4195	3.2085	3.0079	-1.91	1.82
56	3.3060	3.0989	2.9021	-1.95	1.85
57	3.1969	2.9935	2.8005	-2.00	1.89
58	3.0919	2.8922	2.7029	-2.04	1.93
59	2.9909	2.7948	2.6092	-2.08	1.97
60	2.8936	2.7012	2.5193	-2.13	2.01
61	2.8000	2.6112	2.4328	-2.17	2.05
62	2.7099	2.5246	2.3498	-2.22	2.09
63	2.6232	2.4413	2.2700	-2.26	2.13
64	2.5396	2.3611	2.1932	-2.31	2.17
65	2.4591	2.2840	2.1195	-2.36	2.21
66	2.3815	2.2098	2.0486	-2.40	2.25
67	2.3068	2.1383	1.9803	-2.45	2.29
68	2.2347	2.0695	1.9147	-2.49	2.34
69	2.1652	2.0032	1.8516	-2.54	2.38
70	2.0983	1.9393	1.7908	-2.59	2.42
71	2.0337	1.8778	1.7324	-2.63	2.46
72	1.9714	1.8186	1.6761	-2.68	2.50
73	1.9113	1.7614	1.6219	-2.73	2.54
74	1.8533	1.7064	1.5697	-2.78	2.58
75	1.7974	1.6533	1.5194	-2.83	2.63
76	1.7434	1.6021	1.4710	-2.88	2.67
77	1.6913	1.5528	1.4243	-2.92	2.71
78	1.6409	1.5051	1.3794	-2.97	2.75
79	1.5923	1.4592	1.3360	-3.02	2.80
80	1.5454	1.4149	1.2942	-3.07	2.84
81	1.5000	1.3721	1.2540	-3.12	2.88
82	1.4562	1.3308	1.2151	-3.17	2.93
83	1.4139	1.2910	1.1776	-3.22	2.97
84	1.3730	1.2525	1.1415	-3.27	3.01

85	1.3335	1.2153	1.1066	-3.32	3.06
86	1.2953	1.1794	1.0730	-3.38	3.10
87	1.2583	1.1448	1.0405	-3.43	3.15
88	1.2226	1.1113	1.0092	-3.48	3.19
89	1.1880	1.0789	0.9789	-3.53	3.24
90	1.1546	1.0476	0.9497	-3.58	3.28
91	1.1223	1.0174	0.9215	-3.64	3.33
92	1.0910	0.9882	0.8942	-3.69	3.37
93	1.0607	0.9599	0.8679	-3.74	3.42
94	1.0314	0.9326	0.8424	-3.80	3.46
95	1.0030	0.9061	0.8179	-3.85	3.51
96	0.9756	0.8806	0.7941	-3.90	3.55
97	0.9490	0.8558	0.7711	-3.96	3.60
98	0.9232	0.8319	0.7489	-4.01	3.64
99	0.8983	0.8088	0.7275	-4.07	3.69
100	0.8741	0.7863	0.7067	-4.12	3.74
101	0.8507	0.7646	0.6867	-4.18	3.78
102	0.8281	0.7436	0.6672	-4.23	3.83
103	0.8061	0.7233	0.6484	-4.29	3.88
104	0.7848	0.7036	0.6303	-4.34	3.92
105	0.7641	0.6845	0.6127	-4.40	3.97
106	0.7441	0.6661	0.5957	-4.46	4.02
107	0.7247	0.6482	0.5792	-4.51	4.07
108	0.7059	0.6308	0.5632	-4.57	4.12
109	0.6877	0.6140	0.5478	-4.63	4.16
110	0.6700	0.5977	0.5328	-4.69	4.21
111	0.6528	0.5820	0.5183	-4.74	4.26
112	0.6361	0.5667	0.5043	-4.80	4.31
113	0.6200	0.5518	0.4907	-4.86	4.36
114	0.6043	0.5374	0.4775	-4.92	4.41
115	0.5891	0.5235	0.4648	-4.98	4.45
116	0.5743	0.5100	0.4524	-5.04	4.50
117	0.5600	0.4968	0.4404	-5.10	4.55
118	0.5460	0.4841	0.4288	-5.16	4.60
119	0.5325	0.4717	0.4175	-5.22	4.65
120	0.5194	0.4597	0.4066	-5.28	4.70



## Discharging Sensor

R80°C=50KΩ±3%

B25/80°C=4450K±3%

Temp.((°C))	Max.(KΩ)	Normal(KΩ)	Min.(KΩ)	Tolerance(°C)	
-30	14646.0505	12061.7438	9924.4999	-2.96	2.45
-29	13654.1707	11267.8730	9290.2526	-2.95	2.44
-28	12735.8378	10531.3695	8700.6388	-2.93	2.44
-27	11885.1336	9847.7240	8152.2338	-2.92	2.43
-26	11096.6531	9212.8101	7641.8972	-2.91	2.42
-25	10365.4565	8622.8491	7166.7474	-2.90	2.42
-24	9687.0270	8074.3787	6724.1389	-2.88	2.41
-23	9057.2314	7564.2244	6311.6413	-2.87	2.41
-22	8472.2852	7089.4741	5927.0206	-2.86	2.40
-21	7928.7217	6647.4547	5568.2222	-2.84	2.39
-20	7423.3626	6235.7109	5233.3554	-2.83	2.39
-19	6953.2930	5851.9864	4920.6791	-2.82	2.38
-18	6515.8375	5494.2064	4628.5894	-2.80	2.37
-17	6108.5393	5160.4621	4355.6078	-2.79	2.37
-16	5729.1413	4848.9963	4100.3708	-2.77	2.36
-15	5375.5683	4558.1906	3861.6201	-2.76	2.35
-14	5045.9114	4286.5535	3638.1938	-2.75	2.34
-13	4738.4141	4032.7098	3429.0191	-2.73	2.34
-12	4451.4586	3795.3910	3233.1039	-2.72	2.33
-11	4183.5548	3573.4260	3049.5312	-2.70	2.32
-10	3933.3289	3365.7336	2877.4527	-2.69	2.31
-9	3699.5139	3171.3148	2716.0828	-2.67	2.30
-8	3480.9407	2989.2460	2564.6945	-2.66	2.29
-7	3276.5302	2818.6731	2422.6139	-2.64	2.28
-6	3085.2854	2658.8058	2289.2164	-2.63	2.28
-5	2906.2851	2508.9126	2163.9230	-2.61	2.27
-4	2738.6777	2368.3158	2046.1961	-2.60	2.26
-3	2581.6752	2236.3876	1935.5371	-2.58	2.25
-2	2434.5487	2112.5459	1831.4826	-2.56	2.24
-1	2296.6230	1996.2509	1733.6024	-2.55	2.23
0	2167.2730	1887.0018	1641.4966	-2.53	2.22
1	2045.9191	1784.3336	1554.7931	-2.52	2.21
2	1932.0242	1687.8144	1473.1460	-2.50	2.20
3	1825.0899	1597.0431	1396.2333	-2.48	2.19
4	1724.6540	1511.6468	1323.7551	-2.47	2.17
5	1630.2870	1431.2787	1255.4324	-2.45	2.16
6	1541.5904	1355.6163	1191.0048	-2.43	2.15
7	1458.1938	1284.3593	1130.2298	-2.41	2.14
8	1379.7528	1217.2282	1072.8813	-2.40	2.13
9	1305.9472	1153.9626	1018.7481	-2.38	2.12

10	1236.4792	1094.3200	967.6334	-2.36	2.11
11	1171.0715	1038.0743	919.3533	-2.35	2.09
12	1109.4661	985.0146	873.7359	-2.33	2.08
13	1051.4226	934.9440	830.6210	-2.31	2.07
14	996.7169	887.6792	789.8583	-2.29	2.06
15	945.1404	843.0486	751.3077	-2.27	2.04
16	896.4981	800.8922	714.8380	-2.26	2.03
17	850.6086	761.0603	680.3265	-2.24	2.02
18	807.3024	723.4134	647.6580	-2.22	2.00
19	766.4212	687.8205	616.7252	-2.20	1.99
20	727.8172	654.1596	587.4271	-2.18	1.98
21	691.3524	622.3161	559.6694	-2.16	1.96
22	656.8979	592.1831	533.3634	-2.14	1.95
23	624.3328	563.6604	508.4261	-2.12	1.93
24	593.5446	536.6540	484.7796	-2.10	1.92
25	564.4275	511.0760	462.3510	-2.09	1.90
26	536.9865	486.9352	441.1516	-2.07	1.89
27	511.0105	464.0500	421.0258	-2.05	1.87
28	486.4151	442.3499	401.9146	-2.03	1.86
29	463.1208	421.7683	383.7626	-2.01	1.84
30	441.0535	402.2430	366.5175	-1.99	1.83
31	420.1431	383.7151	350.1301	-1.97	1.81
32	400.3242	366.1295	334.5542	-1.95	1.80
33	381.5350	349.4341	319.7460	-1.93	1.78
34	363.7176	333.5801	305.6645	-1.90	1.76
35	346.8176	318.5216	292.2709	-1.88	1.75
36	330.7839	304.2151	279.5286	-1.86	1.73
37	315.5682	290.6199	267.4031	-1.84	1.71
38	301.1254	277.6976	255.8620	-1.82	1.70
39	287.4128	265.4119	244.8745	-1.80	1.68
40	274.3905	253.7288	234.4118	-1.78	1.66
41	262.0206	242.6161	224.4465	-1.76	1.64
42	250.2676	232.0436	214.9529	-1.74	1.63
43	239.0983	221.9825	205.9065	-1.71	1.61
44	228.4809	212.4060	197.2844	-1.69	1.59
45	218.3860	203.2887	189.0648	-1.67	1.57
46	208.7855	194.6066	181.2273	-1.65	1.55
47	199.6531	186.3369	173.7524	-1.63	1.54
48	190.9639	178.4584	166.6217	-1.60	1.52
49	182.6945	170.9508	159.8181	-1.58	1.50
50	174.8228	163.7951	153.3249	-1.56	1.48
51	167.3280	156.9733	147.1268	-1.53	1.46
52	160.1904	150.4683	141.2090	-1.51	1.44
53	153.3914	144.2641	135.5577	-1.49	1.42

54	146.9136	138.3454	130.1598	-1.47	1.40
55	140.7403	132.6980	125.0027	-1.44	1.38
56	134.8559	127.3081	120.0746	-1.42	1.36
57	129.2457	122.1630	115.3645	-1.40	1.34
58	123.8956	117.2504	110.8618	-1.37	1.32
59	118.7926	112.5589	106.5564	-1.35	1.30
60	113.9241	108.0776	102.4388	-1.32	1.28
61	109.2784	103.7961	98.5000	-1.30	1.26
62	104.8443	99.7046	94.7315	-1.28	1.23
63	100.6112	95.7939	91.1253	-1.25	1.21
64	96.5692	92.0553	87.6735	-1.23	1.19
65	92.7088	88.4805	84.3690	-1.20	1.17
66	89.0211	85.0614	81.2048	-1.18	1.15
67	85.4976	81.7908	78.1744	-1.15	1.12
68	82.1303	78.6615	75.2715	-1.13	1.10
69	78.9116	75.6668	72.4902	-1.10	1.08
70	75.8343	72.8004	69.8249	-1.08	1.06
71	72.8916	70.0561	67.2703	-1.05	1.03
72	70.0770	67.4283	64.8213	-1.03	1.01
73	67.3844	64.9115	62.4731	-1.00	0.99
74	64.8080	62.5006	60.2211	-0.98	0.96
75	62.3423	60.1906	58.0609	-0.95	0.94
76	59.9821	57.9770	55.9885	-0.92	0.92
77	57.7223	55.8552	53.9998	-0.90	0.89
78	55.5583	53.8210	52.0912	-0.87	0.87
79	53.4856	51.8706	50.2591	-0.85	0.84
80	51.5000	50.0000	48.5000	-0.85	0.84
81	49.7063	48.2057	46.7083	-0.85	0.85
82	47.9835	46.4842	44.9911	-0.89	0.89
83	46.3286	44.8323	43.3452	-0.93	0.92
84	44.7385	43.2468	41.7672	-0.96	0.95
85	43.2105	41.7248	40.2540	-1.00	0.99
86	41.7386	40.2604	38.7996	-1.03	1.02
87	40.3241	38.8545	37.4048	-1.07	1.06
88	38.9643	37.5045	36.0668	-1.11	1.09
89	37.6569	36.2078	34.7831	-1.14	1.13
90	36.3996	34.9622	33.5513	-1.18	1.16
91	35.1903	33.7653	32.3689	-1.22	1.19
92	34.0269	32.6151	31.2338	-1.26	1.23
93	32.9075	31.5096	30.1438	-1.30	1.27
94	31.8302	30.4467	29.0970	-1.33	1.30
95	30.7933	29.4246	28.0915	-1.37	1.34
96	29.7950	28.4417	27.1254	-1.41	1.37
97	28.8337	27.4961	26.1970	-1.45	1.41

98	27.9078	26.5864	25.3048	-1.49	1.44
99	27.0160	25.7110	24.4470	-1.53	1.48
100	26.1569	24.8685	23.6222	-1.57	1.52
101	25.3290	24.0574	22.8291	-1.61	1.55
102	24.5311	23.2765	22.0662	-1.65	1.59
103	23.7620	22.5245	21.3323	-1.69	1.63
104	23.0205	21.8002	20.6261	-1.73	1.66
105	22.3055	21.1025	19.9465	-1.77	1.70
106	21.6159	20.4303	19.2924	-1.81	1.74
107	20.9508	19.7825	18.6626	-1.85	1.77
108	20.3091	19.1582	18.0563	-1.89	1.81
109	19.6899	18.5564	17.4723	-1.93	1.85
110	19.0924	17.9761	16.9098	-1.98	1.89
111	18.5157	17.4166	16.3680	-2.02	1.93
112	17.9590	16.8769	15.8458	-2.06	1.96
113	17.4214	16.3564	15.3427	-2.10	2.00
114	16.9023	15.8542	14.8577	-2.15	2.04
115	16.4010	15.3696	14.3902	-2.19	2.08
116	15.9167	14.9020	13.9394	-2.23	2.12
117	15.4489	14.4506	13.5047	-2.27	2.16
118	14.9968	14.0149	13.0855	-2.32	2.19
119	14.5599	13.5942	12.6811	-2.36	2.23
120	14.1376	13.1879	12.2909	-2.41	2.27
121	13.7294	12.7955	11.9144	-2.45	2.31
122	13.3347	12.4165	11.5510	-2.50	2.35
123	12.9531	12.0503	11.2003	-2.54	2.39
124	12.5840	11.6965	10.8617	-2.58	2.43
125	12.2270	11.3545	10.5348	-2.63	2.47
126	11.8817	11.0240	10.2191	-2.68	2.51
127	11.5475	10.7046	9.9142	-2.72	2.55
128	11.2242	10.3957	9.6197	-2.77	2.59
129	10.9112	10.0970	9.3352	-2.81	2.63
130	10.6084	9.8082	9.0602	-2.86	2.67
131	10.3151	9.5288	8.7945	-2.91	2.71
132	10.0312	9.2586	8.5378	-2.95	2.75
133	9.7563	8.9971	8.2895	-3.00	2.80
134	9.4901	8.7441	8.0495	-3.05	2.84
135	9.2322	8.4993	7.8175	-3.09	2.88
136	8.9824	8.2623	7.5931	-3.14	2.92
137	8.7404	8.0329	7.3760	-3.19	2.96
138	8.5059	7.8108	7.1660	-3.24	3.00
139	8.2787	7.5958	6.9629	-3.29	3.04
140	8.0584	7.3875	6.7664	-3.33	3.09

## 6. System Configuration

### 6.1 System Configuration

After the installation and test operation of the room air conditioner have been completed, it should be operated and handled as described below. Every user would like to know the correct method of operation of the room air conditioner, to check if it is capable of cooling (or heating) well, and to know a clever method of using it. In order to meet this expectation of the users, giving sufficient explanations taking enough time can be said to reduce about 80% of the requests for servicing. However good the installation work is and however good the functions are, the customer may blame either the room air conditioner or its installation work because of improper handling. The installation work and handing over of the unit can only be considered to have been completed when its handling has been explained to the user without using technical terms but giving full knowledge of the equipment.

### 6.2 Instruction

# Parts and Functions

## Indoor Unit

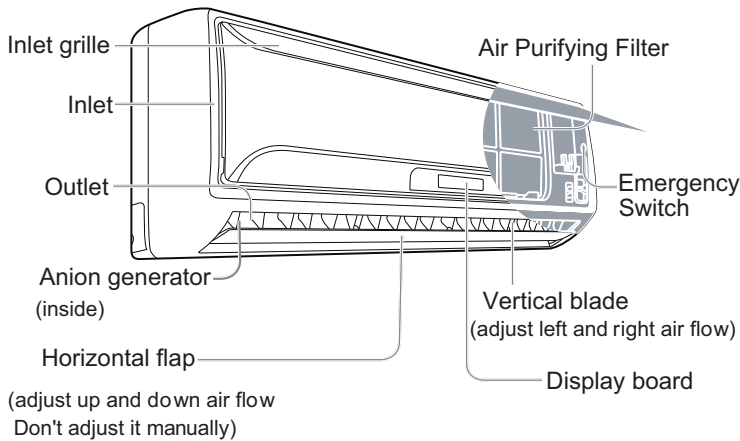

Actual inlet grille may vary from the one shown in the manual according to the product purchased

### Display board for 12:

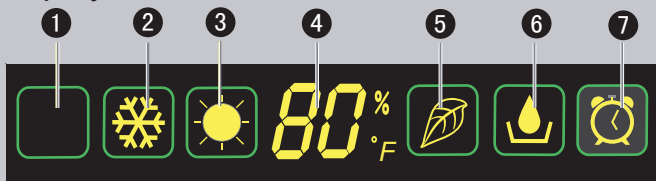

- 1 Singal receiver hole
  - 2 COOL display
  - 3 HEAT display
  - 4 TEMP display
  - 5 HEALTH display
  - 6 Dry display
  - 7 TIMER OFF display
- (If the unit which you purchased has healthy function, follow it. If not, please ignore.)
- 6 Dry display
  - 7 TIMER OFF display
  - TIMER ON display
  - SLEEP display

### Display board for 18:

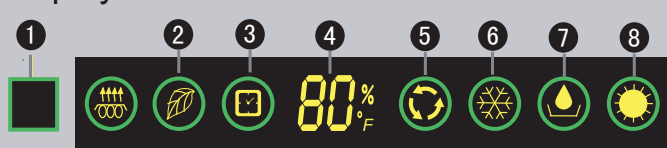

- 1 Remote signal receiver
- 2 HEALTH display
- 3 TIMER OFF display
- 4 TEMP display
- 5 AUTO display
- 6 COOL display
- 7 Dry display
- 8 HEAT display

## Outdoor Unit

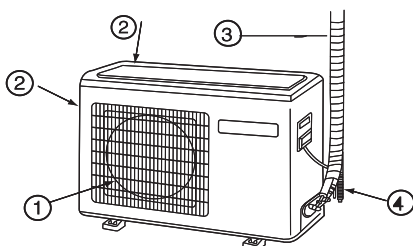

- 1 OUTLET
- 2 INLET
- 3 CONNECTING PIPING AND ELECTRICAL WIRING
- 4 DRAIN HOSE

## Remote controller

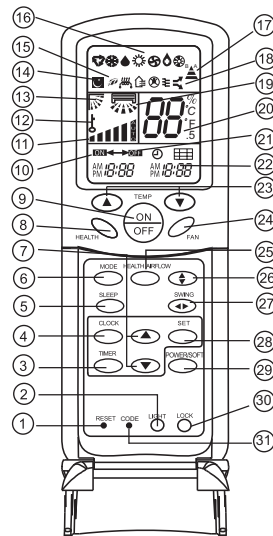

- 8. HEALTH button
- 9. ON/OFF button
- 10. TIMER ON display
- 11. FAN SPEED display



- 12. LOCK display
- 13. SWING UP/DOWN display
- 14. SLEEP display
- 15. HEALTH display
- 16. OPERATION mode display

Operation mode	AUTO	COOL	DRY	HEAT	FAN
Remote controller					

- 17. Singal sending display
  - 18. POWER/SOFT display
  - 19. Left/right air flow display
  - 20. TEMP display
  - 21. TIMER OFF display
  - 22. TIMER display
  - 23. TEMP button
  - 24. FAN button
  - 25. HEALTH AIRFLOW button
  - 26. SWING UP/DOWN button
  - 27. SWING LEFT/RIGHT button
  - 28. SET button
  - 29. POWER/SOFT button
  - 30. LOCK button
  - 31. CODE button
- Use to select CODE A or B which will be displayed on LCD. Please select A without special explanation.

- 1. RESET button
- When the remote controller appears abnormal, use a sharp pointed article to press this button to reset the remote controller normal.
- 2. LIGHT button
- Control the lightening and extinguishing of the indoor LED display board.
- 3. TIMER button
- 4. CLOCK button
- 5. SLEEP button
- 6. MODE button
- 7. HOUR button

### NOTE:

Cooling only unit do not have functions and displays related with heating.

## Loading of the battery

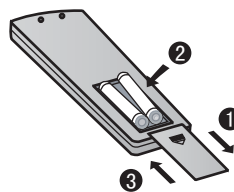

- 1 Remove the battery cover;
- 2 Load the batteries as illustrated. 2 R-03 batteries, resetting key (cylinder);
- 3 Be sure that the loading is in line with the "+" / "-";
- 4 Load the battery, then put on the cover again.

### Note:

- The distance between the signal transmission head and the receiver hole should be within 7m without any obstacle as well.
- When electronic-started type fluorescent lamp or change-over type fluorescent lamp or wireless telephone is installed in the room, the receiver is apt to be disturbed in receiving the signals, so the distance to the indoor unit should be shorter.
- Full display or unclear display during operation indicates the batteries have been used up. Please change batteries.
- If the remote controller can't run normally during operation, please remove the batteries and reload several minutes later.

### Hint:

Remove the batteries in case unit won't be in usage for a long period. If there are any display after taking-out, just need to press reset key.

# Operation

## Clock set

Press CLOCK button, "AM" or "PM" flashes.  
 Press  $\Delta$  or  $\nabla$  to set correct time. Each press will increase or decrease 1min. If the button is kept pressed, time will change quickly. After time setting is confirmed, press SET, "AM" and "PM" stop flashing, while clock starts working.



## Base Operation

Remote controller

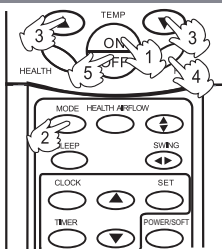

### 1. Unit start

Press ON/OFF on the remote controller, unit starts.

### 2. Select operation mode

Press MODE button. For each press, operation mode changes as follows:

Remote controller:



### 3. Select temp. setting

Press  $\Delta$  /  $\nabla$  button

- $\Delta$  Every time the button is pressed, temp. setting increase 2°F, if kept depressed, it will increase rapidly
- $\nabla$  Every time the button is pressed, temp. setting decrease 2°F, if kept depressed, it will decrease rapidly

Select a desired temperature.

### 4. Fan speed selection

Press FAN button. For each press, fan speed changes as follows:

Remote controller:



Air conditioner is running under displayed fan speed. When FAN is set to AUTO, the air conditioner automatically adjusts the fan speed according to room temperature.

Operation Mode	Display Board	Remote Controller	Note
AUTO	For 12:		Under the mode of auto operation, air conditioner will automatically select Cool or Heat operation according to room temperature. When FAN is set to AUTO, the air conditioner automatically adjusts the fan speed according to room temperature.
	For 18:		
COOL	For 12:		
	For 18:		
DRY	For 12:		In DRY mode, when room temperature becomes lower than temp. setting about +35°F, unit will run intermittently at LOW speed regardless of FAN setting.
	For 18:		
HEAT	For 12:		
	For 18:		
FAN	nothing		In FAN operation mode, the unit will not operate in COOL or HEAT mode but only in FAN mode. AUTO is not available in FAN mode. And temp. setting is disabled. In FAN mode, SLEEP operation is not available.

## Emergency operation and test operation

### Emergency Operation:

Use this operation only when the remote controller is defective or lost.

- When the emergency operation switch is pressed, the "Pi" sound is heard once, which means the start of this operation.
- In this operation, the system automatically selects the operation modes, cooling or fan or heat, according to the room temperature.
- When machine is running in emergency, the set value of temperature and wind speed couldn't be altered; meanwhile, it can't operate for dehumidifying or under timing mode.

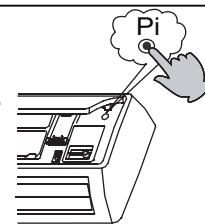

### Test operation:

Test operation switch is the same as emergency switch.

- Use this switch in the test operation when the room temperature is below 60°F, do not use it in the normal operation.

- Continue to press the test operation switch for more than 5 seconds. After you hear the "Pi" sound twice, release your finger from the switch: the cooling operation starts with the air flow speed "Hi".

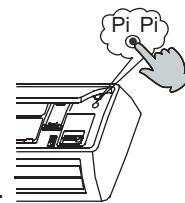

## Air Flow Di

### 1. Status display of air sending

Vertical flap

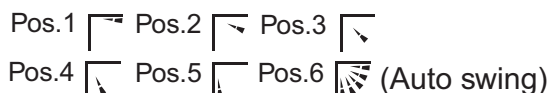

### 2. Left and right air flow adjustment (manual)

Move the vertical blade by a knob on air conditioner to adjust left and right direction referring to Fig.

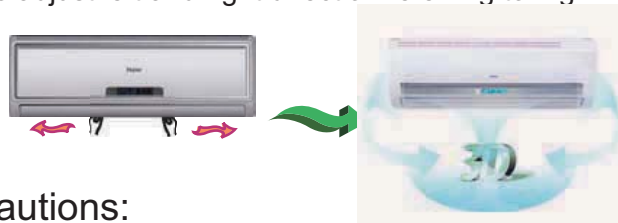

### Cautions:

- When adjusting the flap by hand, turn off the unit.
- When humidity is high, condensate water might occur at air outlet if all vertical louvers are adjusted to left or right.
- It is advisable not to keep horizontal flap at downward position for a long time in COOL or DRY mode, otherwise, condensate water might occur.

Note:

When restart after remote turning off, the remote controller will automatically memorize the previous set swing position.

# Operation

## Sleep Operation

Before going to bed, you can simply press the SLEEP button and unit will operate in SLEEP mode and bring you a sound sleep.



### Use of SLEEP function

After the unit starts, set the operation status, then press SLEEP button before which the clock must be adjusted and time being set.

### Operation Mode

#### 1. In COOL, DRY mode

1 hours after SLEEP mode starts, temp. will become about 2°F higher than temp. setting. After another 1 hours, temp. rises about 2°F further. The unit will run for further 6 hours then stops. Temp. is higher than temp. setting so that room temperature won't be too low for your sleep.

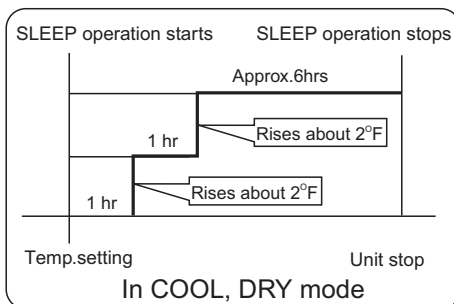

#### 2. In HEAT mode

1 hours after SLEEP mode starts, temp will become about 4°F lower than temp. setting. After another 1 hours, temp decrease about 4°F further. After more another 3 hours, temp. rises about 2°F further. The unit will run for further 3 hours then stops. Temp. is lower than temp. setting so that room temperature won't be too high for your sleep.

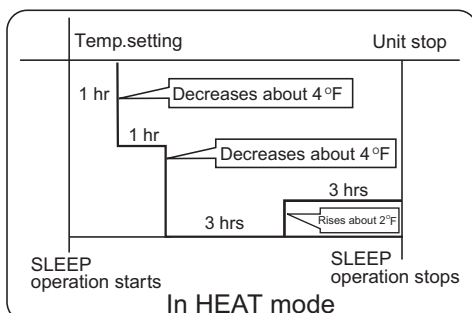

#### 3. In AUTO mode

The unit operates in corresponding sleep mode adapted to the automatically selected operation mode.

#### 4. In FAN mode

It has no SLEEP function.

#### 5. Set the wind speed change when sleeping

If the wind speed is high or middle before setting for the sleep, set for lowering the wind speed after sleeping. If it is low wind, no change.

#### 6. Note to the power failure resume:

press the sleep button ten times in five seconds and enter this function after hearing four sounds. And press the sleep button ten times within five seconds and leave this function after hearing two sounds.

#### NOTE:

With the power failure resume, when setting the TIMER ON, TIMER OFF and TIMER ON/OFF, it's memorized as shutdown status when resuming after power out.

## POWER/SOFT Operation

### (1) POWER Operation

When you need rapid heating or cooling, you can use this function. In COOL mode, fan speed automatically takes high speed of AUTO fan mode. In HEAT mode, fan speed automatically takes medial speed of AUTO fan mode.

### (2) SOFT Operation

You can use this function when silence is needed for rest or reading. In SOFT operation mode, fan speed automatically takes low speed of AUTO fan mode.

#### Note:

During POWER operation, in rapid HEAT or COOL mode, the room will show inhomogeneous temperature distribution. Long period SOFT operation will cause effect of not too cool or not too warm.

To cancel POWER or SOFT operation

Press POWER/SOFT button again, POWER or SOFT disappears.

## HEALTH Operation



### Healthy Negative ion

The anion generator in the airconditioner can generate a lot of anion effectively balance the quantity of position and anion in the air and also to kill bacteria and speed up the dust sediment in the room and finally clean the air in the room.



# Operation

## Timer On/Off On-Off Operation

Set clock correctly before starting TIMER operation.

1. After unit starts, select your desired operation mode.
2. Press TIMER button to change TIMER mode. Every time the button is pressed, display changes as follows:

Remote controller:



Then select your desired TIMER mode (TIMER ON or TIMER OFF or TIMER ON-OFF). "ON" or "OFF" will flash.

3. Press HOUR  $\uparrow$  /  $\downarrow$  button to set time.

It can be adjusted within 24 hours.

4. After setting correct time, press SET button to confirm "ON" or "OFF" on the remote controller stops flashing.

5. Cancel TIMER mode

Just press TIMER button several times until TIMER mode disappears.

Hints:

After replacing batteries or a power failure happens, time setting should be reset.

Remote controller possesses memory function, when use TIMER mode next time, just press SET button after mode selecting if time setting is the same as previous one.

According to the Time setting sequence of TIMER ON or TIMER OFF, either Start-Stop or Stop-Start can be achieved.

## Health airflow Operation

1. Press ON/OFF to starting

Setting the comfort work conditions.

2. The setting of health airflow function

1). Press the button of health airflow,  $\overline{\text{H}}$  appears on the display. Horizontal airflow sending. Avoid the strong airflow blows direct to the body.

2). Press the button of health airflow again,  $\overline{\text{D}}$  appears on the display. Downward airflow sending. Avoid the strong airflow blows direct to the body.

3. The cancel of the health airflow function

Press the button of health airflow again, the unit goes on working under the condition before the setting of health airflow function.

Notice: Cannot pull direct the flap by hand. Otherwise, the grille will run incorrectly. If the grille is not run correctly, stop for a minute and then start, adjusting by remote controller.

Note:

1. After setting the health airflow function, the position grill is fixed.

2. In heating, it is better to select the  $\overline{\text{D}}$  mode.

3. In cooling, it is better to select the  $\overline{\text{H}}$  mode.

4. In cooling and dry, using the air conditioner for a long time under the high air humidity, a phenomenon falling drips of water occurs at the grille.

## IMPORTANT INFORMATION REGARDING THE REFRIGERANT USED

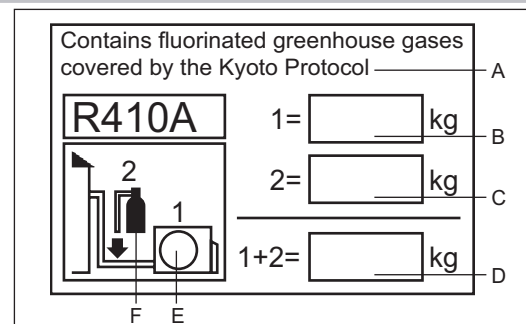

This product contains fluorinated greenhouse gases covered by the Kyoto Protocol. Do not vent into the atmosphere.

Refrigerant type: R410A

GWP\* value: 1975

GWP=global warming potential

Please fill in with indelible ink,

- 1 the factory refrigerant charge of the product
- 2 the additional refrigerant amount charged in the field and
- 1+2 the total refrigerant charge

on the refrigerant charge label supplied with the product. The filled out label must be adhered in the proximity of the product charging port (e.g. onto the inside of the stop valve cover).

A contains fluorinated greenhouse gases covered by the Kyoto Protocol

B factory refrigerant charge of the product: see unit name plate

C additional refrigerant amount charged in the field







D total refrigerant charge

E outdoor unit

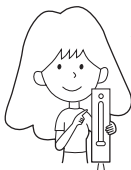
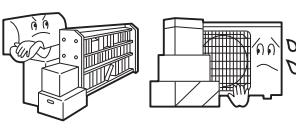

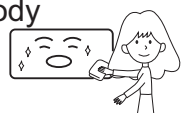
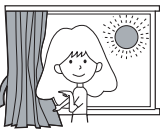
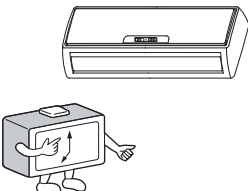
F refrigerant cylinder and manifold for charging

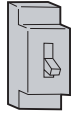
# Maintenance

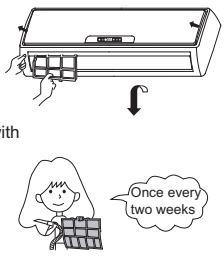
## For Smart Use of The Air Conditioner

<p><b>Setting of proper room temperature</b></p>  <p>Proper temperature</p>	<p><b>Do not block the air inlet or outlet</b></p> 	<p><b>Remote Controller</b></p>  <p>Do not use water, wipe the controller with a dry cloth. Do not use glass cleaner or chemical cloth.</p>	<p><b>Indoor Body</b></p>  <p>Wipe the air conditioner by using a soft and dry cloth. For serious stains, use a neutral detergent diluted with water. Wring the water out of the cloth before wiping, then wipe off the detergent completely.</p>
<p><b>Close doors and windows during operation</b></p>  <p>During cooling operation, prevent the penetration of direct sunlight with curtain or blind.</p>	<p><b>Use the timer effectively</b></p> 	<p><b>Do not use the following for cleaning</b></p>  <p>Gasoline, benzene, thinner or cleanser may damage the coating of the unit.</p>  <p>Hot water over 40°C (104°F) may cause discoloring or deformation.</p>	
<p><b>If the unit is not to be used for a long time, turn off the power supply main switch.</b></p>  <p>OFF</p>	<p><b>Use the louvers effectively</b></p> 	<p><b>Air Filter cleaning</b></p> <ol style="list-style-type: none"> <li><b>1 Open the inlet grille by pulling it upward.</b></li> <li><b>2 Remove the filter.</b> Push up the filter's center tab slightly until it is released from the stopper, and remove the filter downward.</li> <li><b>3 Clean the filter.</b> Use a vacuum cleaner to remove dust, or wash the filter with water. After washing, dry the filter completely in the shade.</li> <li><b>4 Attach the filter.</b> Attach the filter correctly so that the "FRONT" indication is facing to the front. Make sure that the filter is completely fixed behind the stopper. If the right and left filters are not attached correctly, that may cause defects.</li> <li><b>5 Close the inlet grille.</b></li> </ol>  <p>Once every two weeks</p>	

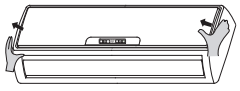
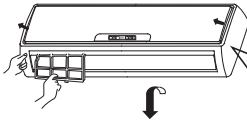
## Replacement of Air Purifying Filter

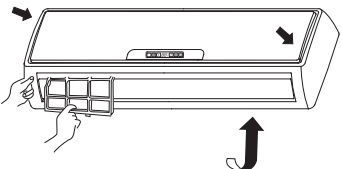
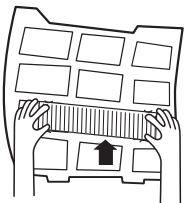
<p><b>1. Open the Inlet Grille</b> Prop up the inlet grille by using a small device named grille-support which located in the right side of the indoor unit.</p>  <p><b>2. Detach the standard air filter</b> Slide the knob slightly upward to release the filter, then withdraw it.</p>  <p>Detach old Air Purifying Filter</p> 	<p><b>4. Attach the standard air filter</b> (Necessary installation)</p>  <p><b>ATTENTION:</b> The white side of the photocatalyst air purifying filter face outside, and the black side face the unit. The green side of the bacteria-killing medium air purifying filter face outside, and the white side face the unit.</p> <p><b>5. Close the Inlet Grille</b> Close the Grille surely</p>
<p><b>3. Attach Air Purifying Filter</b> Put air purifying filter appliances into the right and left filter frames.</p> 	<p><b>NOTE:</b></p> <ul style="list-style-type: none"> <li>The photocatalyst air purifying filter will be solarized in fixed time. In normal family, it will be solarized every 6 months.</li> <li>The bacteria-killing medium air purifying filter will be used for a long time, no need for replacement. But in the period of using them, you should remove the dust frequently by using vacuum cleaner or flapping them lightly, otherwise, its performance will be affected.</li> <li>Please keep the bacteria-killing medium air purifying filter in the cool and dry conditions, avoid long time directly sunshine when you stop using it, or its ability of sterilization will be reduced.</li> </ul>

# Cautions

## ⚠ WARNING

Please call Sales/Service Shop for the Installation.

Do not attempt to install the air conditioner by yourself because improper works may cause electric shock, fire, water leakage.

## ⚠ WARNING

When abnormality such as burnt-small found, immediately stop the operation button and contact sales shop.

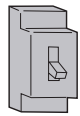

OFF

STRICT  
ENFORCEMENT

Use an exclusive power source with a circuit breaker

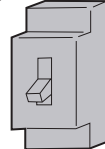

Check proper installation of the drainage securely

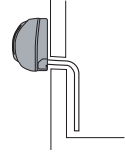
STRICT  
ENFORCEMENT

Connect power supply cord to the outlet completely

STRICT  
ENFORCEMENT

Use the proper voltage

STRICT  
ENFORCEMENT

1. Do not use power supply cord extended or connected in halfway
2. Do not install in the place where there is any possibility of inflammable gas leakage around the unit.
3. Do not get the unit exposed to vapor or oil steam.



PROHIBITION

Do not use power supply cord in a bundle.

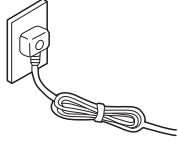

PROHIBITION

Take care not to damage the power supply cord.

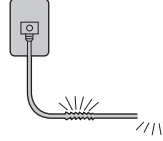

PROHIBITION

Do not insert objects into the air inlet or outlet.



PROHIBITION

Do not start or stop the operation by disconnecting the power supply cord and so on.



PROHIBITION

Do not channel the air flow directly at people, especially at infants or the aged.



PROHIBITION

Do not try to repair or reconstruct by yourself.

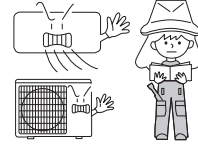

Connect the earth cable.

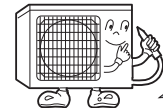

earthing

## ⚠ CAUTION

Do not use for the purpose of storage of food, art work, precise equipment, breeding, or cultivation.



PROHIBITION

Take fresh air occasionally especially when gas appliance is running at the same time.

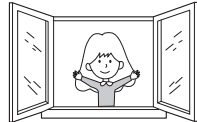
STRICT  
ENFORCEMENT

Do not operate the switch with wet hand.

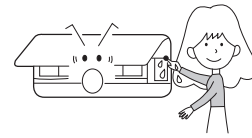

PROHIBITION

Do not install the unit near a fireplace or other heating apparatus.

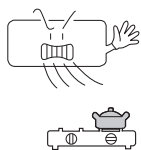

PROHIBITION

Check good condition of the installation stand

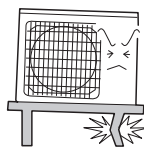

PROHIBITION

Do not pour water onto the unit for cleaning

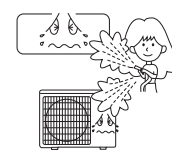

PROHIBITION

Do not place animals or plants in the direct path of the air flow

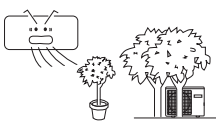

PROHIBITION

Do not place any objects on or climb on the unit.

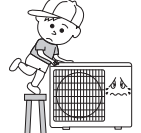

PROHIBITION

Do not place flower vase or water containers on the top of the unit.





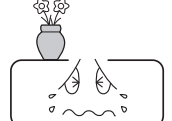

PROHIBITION



# Trouble shooting

Before asking for service, check the following first.

	Phenomenon	Cause or check points
Normal Performance inspection	The system does not restart immediately. 	<ul style="list-style-type: none"> <li>When unit is stopped, it won't restart immediately until 3 minutes have elapsed to protect the system.</li> <li>When the electric plug is pulled out and reinserted, the protection circuit will work for 3 minutes to protect the air conditioner.</li> </ul>
	Noise is heard 	<ul style="list-style-type: none"> <li>During unit operation or at stop, a swishing or gurgling noise may be heard. At first 2-3 minutes after unit start, this noise is more noticeable. (This noise is generated by refrigerant flowing in the system.)</li> <li>During unit operation, a cracking noise may be heard. This noise is generated by the casing expanding or shrinking because of temperature changes.</li> <li>Should there be a big noise from air flow in unit operation, air filter may be too dirty.</li> </ul>
	Smells are generated.	<ul style="list-style-type: none"> <li>This is because the system circulates smells from the interior air such as the smell of furniture, paint, cigarettes.</li> </ul>
	Mist or steam are blown out. 	<ul style="list-style-type: none"> <li>During COOL or DRY operation, indoor unit may blow out mist. This is due to the sudden cooling of indoor air.</li> </ul>
	In dry mode, fan speed can't be changed.	<ul style="list-style-type: none"> <li>In DRY mode, when room temperature becomes lower than temp. setting+3.6°F, unit will run intermittently at LOW speed regardless of FAN setting.</li> </ul>
Multiple check		<ul style="list-style-type: none"> <li>Is power plug inserted?</li> <li>Is there a power failure?</li> <li>Is fuse blownout?</li> </ul>
	Poor cooling 	<ul style="list-style-type: none"> <li>Is the air filter dirty? Normally it should be cleaned every 15 days.</li> <li>Are there any obstacles before inlet and outlet?</li> <li>Is temperature set correctly?</li> <li>Are there some doors or windows left open?</li> <li>Is there any direct sunlight through the window during the cooling operation?(Use curtain)</li> <li>Are there too much heat sources or too many people in the room during cooling operation?</li> </ul>

# Cautions

- Do not obstruct or cover the ventilation grille of the air conditioner. Do not put fingers or any other things into the inlet/outlet and swing louver.
- Do not allow children to play with the air conditioner. In no case should children be allowed to sit on the outdoor unit.

## Specifications

- The refrigerating circuit is leak-proof.

The machine is adaptive in following situation

1. Applicable ambient temperature range:

Cooling	Indoor	Maximum: D.B/W.B 32°C/23°C Minimum: D.B/W.B 21°C/15°C
	Outdoor	Maximum: D.B/W.B 43°C/26°C Minimum: D.B 18°C
Heating	Indoor	Maximum: D.B 27°C Minimum: D.B 0°C
	Outdoor	Maximum: D.B/W.B 24°C/18°C Minimum: D.B/W.B -7°C/-8°C
	Outdoor (INVERTER)	Maximum: D.B/W.B 24°C/18°C Minimum: D.B -15°C

- If the power supply cord is damaged, it must be replaced by the manufacturer or its service agent or a similar qualified person.
- If the fuse of indoor unit on PC board is broken, please change it with the type of T. 3.15A/ 250V. If the fuse of outdoor unit is broken, change it with the type of T.25A/250V
- The wiring method should be in line with the local wiring standard.
- After installation, the power plug should be easily reached.
- The waste battery should be disposed properly.
- The appliance is not intended for use by young children or infirm persons without supervision.
- Young children should be supervised to ensure that they do not play with the appliance.
- Please employ the proper power plug, which fit into the power supply cord.
- A breaker should be incorporated into fixed wiring. The breaker should be all-pole switch and the distance between its two contacts should be not less than 3mm.
- The power plug and connecting cable must have acquired the local attestation.
- In order to protect the units, please turn off the A/C first, and at least 30 seconds later, cutting off the power.

## 7 Service Diagnosis

### 7.1 Caution for Diagnosis

The operation lamp flashes when any of the following errors is detected.

1. When a protection device of the indoor or outdoor unit is activated or when the thermistor malfunctions, disabling equipment operation.
2. When a signal transmission error occurs between the indoor and outdoor units. In either case, conduct the diagnostic procedure described in the following pages.

### 7.2. Problem Symptoms and Measures

Symptom	Check Item	Details of Measure
None of the units operates	Check the power supply.	Check to make sure that the rated voltage is supplied.
	Check the indoor PCB	Check to make sure that the indoor PCB is broken
Operation sometimes stops.	Check the power supply.	A power failure of 2 to 10 cycles can stop air conditioner operation.
Equipment operates but does not cool, or does not heat (only for heat pump)	Check for faulty operation of the electronic expansion valve.	Set the units to cooling operation, and compare the temperatures of the liquid side connection pipes of the connection section among rooms to check the opening and closing operation of the electronic expansion valves of the individual units.
	Diagnosis by service port pressure and operating current.	Check for insufficient gas.
Large operating noise and vibrations	Check the installation condition.	Check to make sure that the required spaces for installation (specified in the Technical Guide, etc.) are provided.

### 7.3.Error Codes and Description indoor display

	Code indication		Description	Reference Page
	indoor	Outdoor (LED1 flash times)		
Indoorand Outdoor	E7	15	Communication fault between indoor and outdoor units	Page .60
Indoor Malfunction	E1		Room temperature sensor failure	Page .52
	E2		Heat-exchange sensor failure	Page .52
	E4		Indoor EEPROM error	Page .58
	E14		Indoor fan motor malfunction	Page .53
Outdoor Malfunction		1	Outdoor EEPROM error	Page .59
		2	The protection of IPM	Page .55
		3	Overcurrent protection of AC electricity for the outdoor model	
		4	Communication fault between the IPM and outdoor PCB	Page 56
		6	Power voltage is too high or low	Page .62
		8	Overheat protection for exhaust temperature	Page .58
		9	outdoor fan motor malfunction	
		10	Frost-removing temperature sensor failure	Page .57
		11	SUCK temperature sensor failure	Page .57
		12	Ambient temperature sensor failure	Page .57
		13	Exhaust temperature sensor failure	Page .57
		18	deviate from the normal for the compressor	Page .63
		19	Loop of the station detect error	Page .63
		24	Overcurrent of the compressor	Page .64
	25	Overcurrent protection for single-phase of the compressor	Page .64	

### 7.3.1 Thermistor or Related Abnormality (indoor unit)

<b>Indoor Display</b>	<b>E1:</b> Room temperature sensor failure <b>E2:</b> Heat-exchange sensor failure
<b>Method of Malfunction Detection</b>	the temperatures detected by the thermistors are used to determine thermistor errors
<b>Malfunction Decision Conditions</b>	when the thermistor input is more than 4.92V or less than 0.08V during compressor operation.
<b>Supposed Causes</b>	* <b>Note:</b> The values vary slightly in some models <ul style="list-style-type: none"> <li>■ Faulty connector connection</li> <li>■ Faulty thermistor</li> <li>■ Faulty PCB</li> </ul>
<b>Troubleshooting</b>	* <b>Caution</b> Be sure to turn off power switch before connect or disconnect connector, or else parts damage may be occurred.

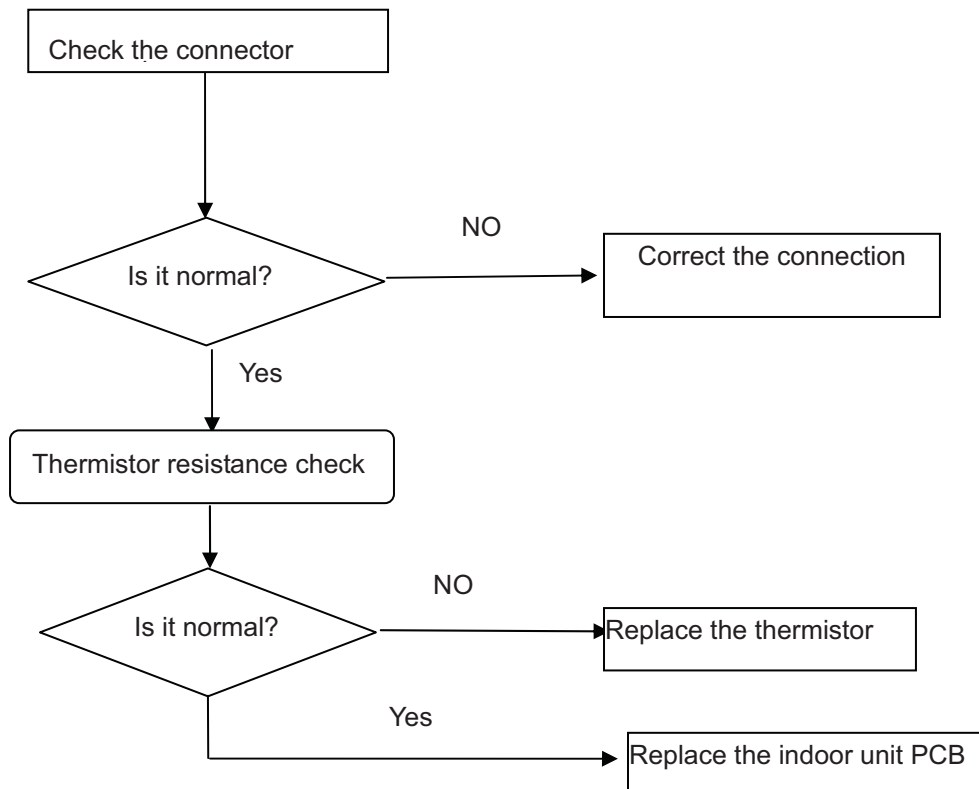

#### Thermistor resistance check method:

Remove the connector of the thermistor on the PCB, and measure the resistance of thermistor using tester. The relationship between normal temperature and resistance is shown in the value of indoor thermistor.

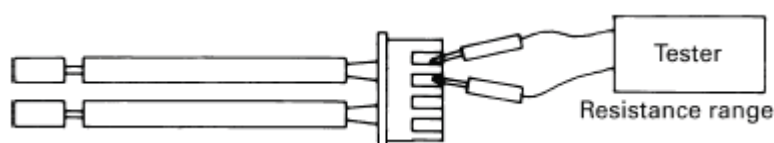

## 7.4.2 Indoor fan motor malfunction

### Indoor Display **E14**

**Method of Malfunction Detection** The rotation speed detected by the Hall IC during fan motor operation is used to determine abnormal fan motor operation

**Malfunction Decision** when the detected rotation feedback signal don't received in 2 minutes

#### Conditions

- Supposed Causes**
- Operation halt due to breaking of wire inside the fan motor .
  - Operation halt due to breaking of the fan motor lead wires
  - Detection error due to faulty indoor unit PCB

### How to check Fan Motor (DC)

1. Check connector connection.
2. Check motor power supply voltage (pins 1-4).
3. Check motor control voltage (pins 4-5).
4. Check rotation command voltage output (pins 4-6).
5. Check rotation pulse input (pins 4-7).

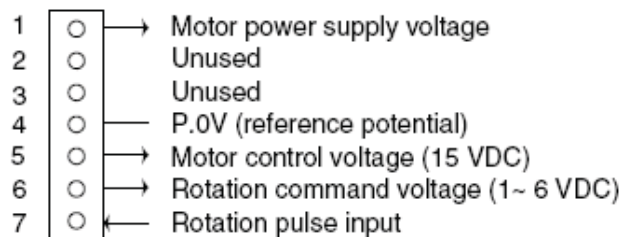

Notes:the a/c is electrifying,don't pull out or insert the terminals of the motor,else the motor would be damaged

**Troubleshooting** \* **Caution** Be sure to turn off power switch before connect or disconnect connector, or else parts damage may be occurred.



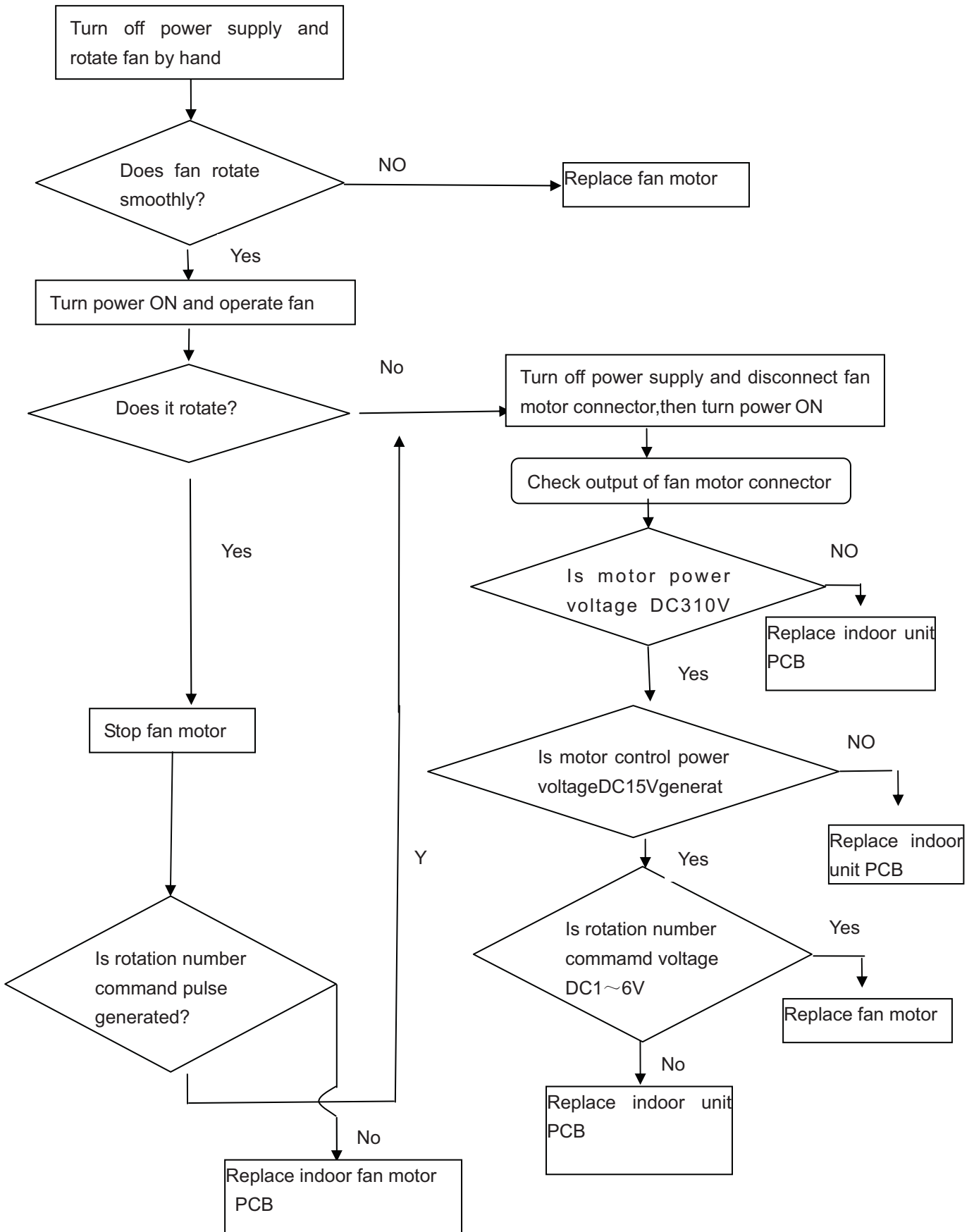

### 7.3.3 IPM protection

<b>outdoor display</b>	LED1 flash 2 times: <b>Indoor Display F1</b>
<b>Method of Malfunction Detection</b>	IPM protection is detected by checking the compressor running condition and so on.
<b>Malfunction Decision Conditions</b>	<ul style="list-style-type: none"> <li>■ The system leads to IPM protection due to over current</li> <li>■ The compressor faulty leads to IPM protection</li> <li>■ circuit component of IPM is broken and led to IPM protection</li> </ul>
<b>Supposed Causes</b>	<ul style="list-style-type: none"> <li>■ IPM protection dues to the compressor faulty</li> <li>■ IPM protection dues to faulty PCB of IPM module</li> <li>■ Compressor wiring disconnected</li> </ul>

**Troubleshooting** \* **Caution** Be sure to turn off power switch before connect or disconnect connector, or else parts damage may be occurred.

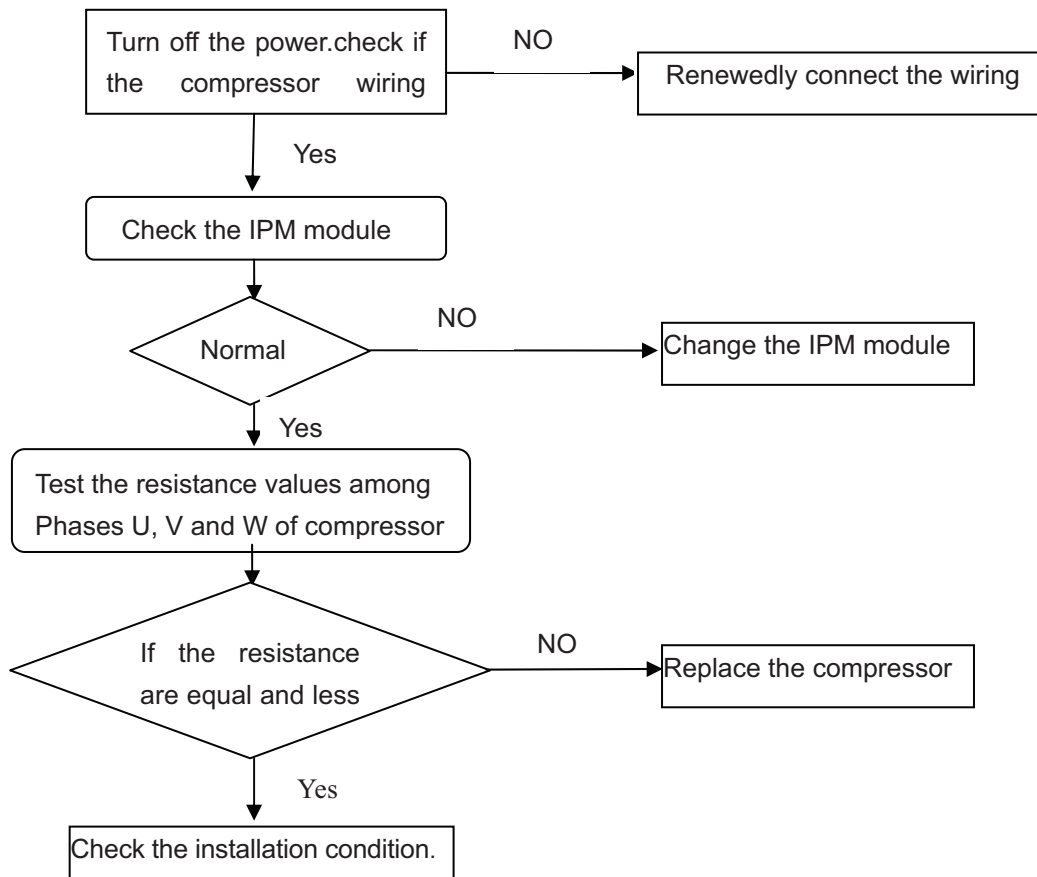

**Check the IPM module method:**

Disconnect the compressor harness connector from the outdoor unit PCB. To disengage the connector, press the protrusion on the connector. Then, to measure resistance between P (+) and N (-) and the U, V and W terminals of the compressor connector with a multi-tester. Evaluate the measurement results for a pass/fail judgment.

N(-)terminal of tester	P(+)	digital	P(+)	UVW	P(-)	UVW
P(+)	terminal of tester	N(-)	digital	UVW	P(+)	UVW
						P(-)

Normal resistance	Several kΩ to several MΩ ( )
Unacceptable resistance	Short (0 Ω) or open

### 7.3.4 The IPM and outdoor PCB don't communicate or Related Abnormality

outdoor display LED1 flash 4 times Indoor Display F3

**Method of Malfunction Detection** Communication is detected by checking the IPM module and the outdoor PCB

**Malfunction Decision Conditions**

- The outdoor PCB broken leads to communication fault
- The IPM module broken leads to communication fault

**Supposed Causes**

- The outdoor PCB is broken
- The IPM module is broken
- Communication wiring disconnected

**Troubleshooting** \* **Caution** Be sure to turn off power switch before connect or disconnect connector, or else parts damage may be occurred.

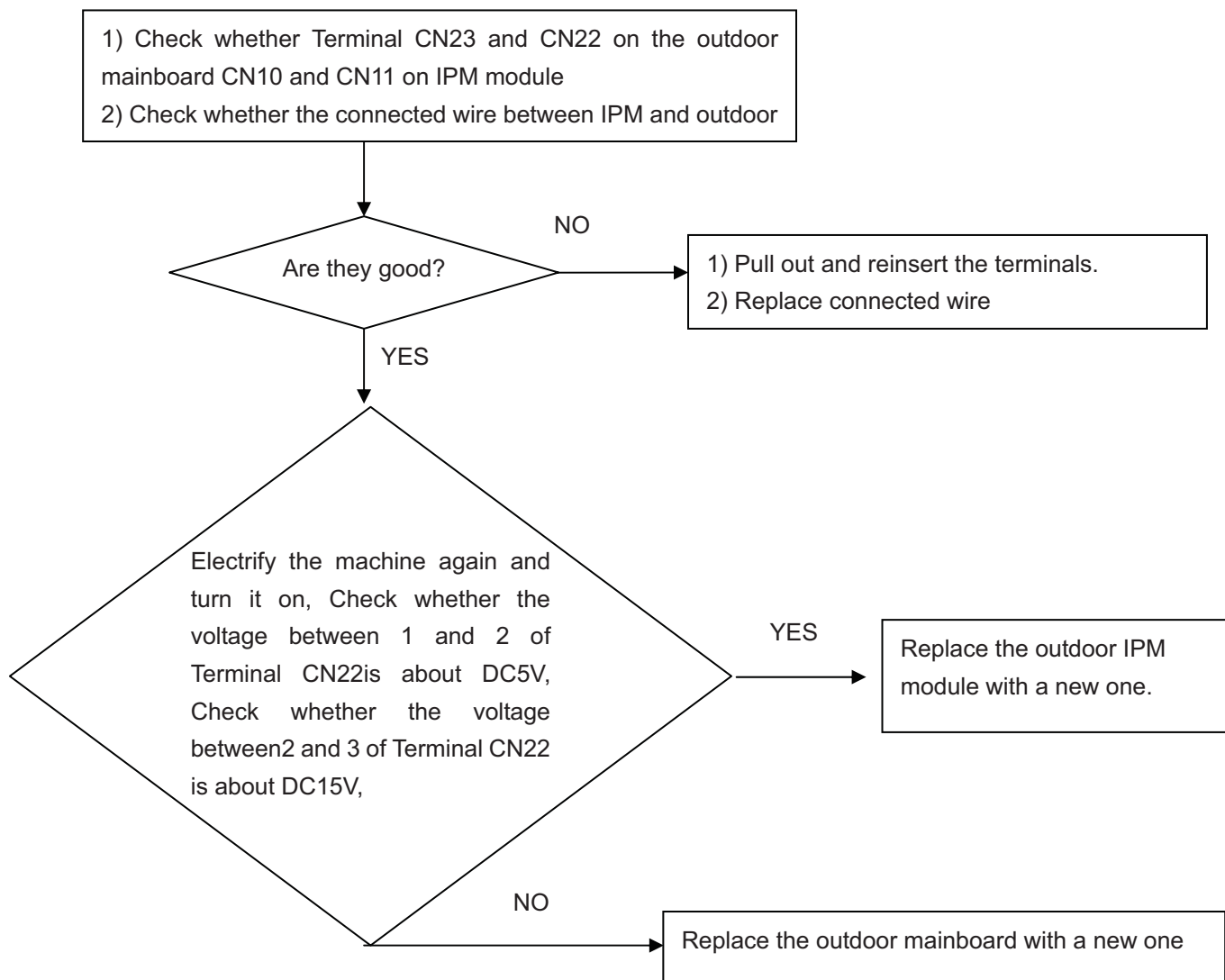

### 7.3.5 Thermistor or Related Abnormality(outdoor unit)

#### Frost-removing temperature sensor failure

Indoor display: F21  
 outdoor display: LED1 flash 10 times:

#### Exhaust temperature sensor failure

Indoor display: F25  
 outdoor display: LED1 flash 13 times:

#### Ambient temperature sensor failure

Indoor display: F6  
 outdoor display: LED1 flash 12 times:

#### Suck temperature sensor failure

Indoor display: F7  
 outdoor display: LED1 flash 11times:

#### Method of Malfunction Detection

This type of error is detected by checking the thermistor input voltage to the microcomputer. (A thermistor error is detected by checking the temperature)

#### Malfunction Decision Conditions

The thermistor input is above 4.9V or below 0.1V with the power on.  
 \* **Note:** The values may vary slightly in some models

#### Supposed Causes

- Faulty connector connection
- Faulty thermistor
- Faulty PCB

**Troubleshooting** \* **Caution** Be sure to turn off power switch before connect or disconnect connector, or else parts damage may be occurred.

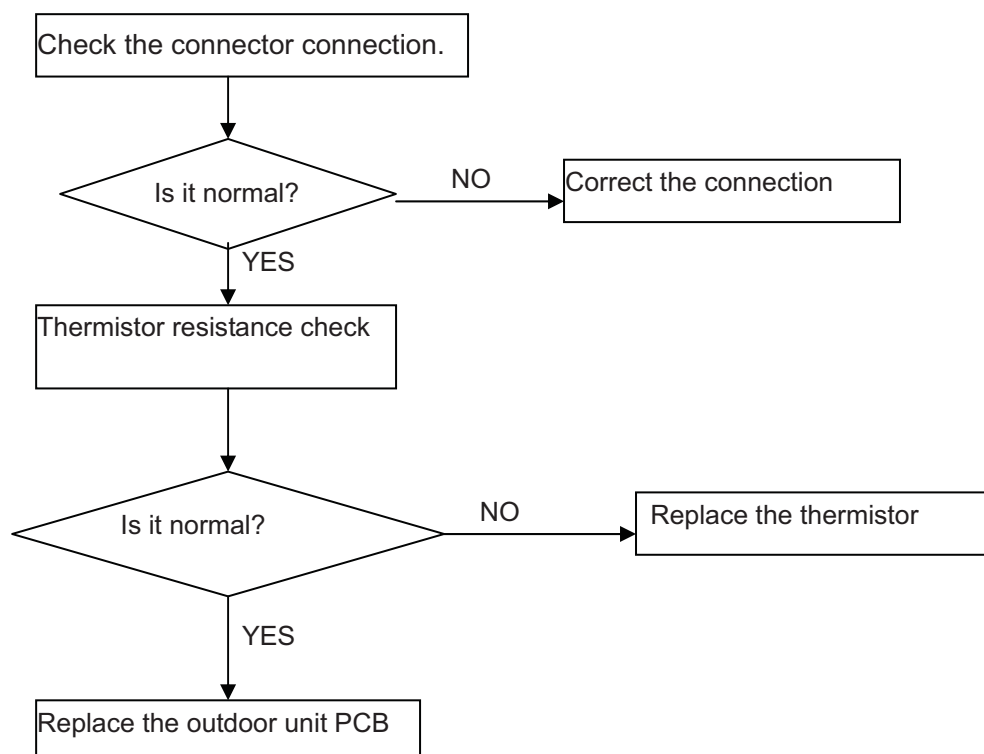

### 7.3.6 Overheat Protection For Exhaust Temperature

<b>Indoor display</b> <b>outdoor display</b>	<b>F4</b> LED1 flash 8 times
<b>Method of Malfunction Detection</b>	the exhaust temperature control is checked with the temperature being detected by the exhaust pipe thermistor
<b>Malfunction Decision Conditions</b>	when the compressor discharge temperature is above 117°C
<b>Supposed Causes</b>	<ul style="list-style-type: none"> <li>■ Electronic expansion valve defective</li> <li>■ Faulty thermistor</li> <li>■ Faulty PCB</li> </ul>

**Troubleshooting** \* **Caution** Be sure to turn off power switch before connect or disconnect connector, or else parts damage may be occurred.

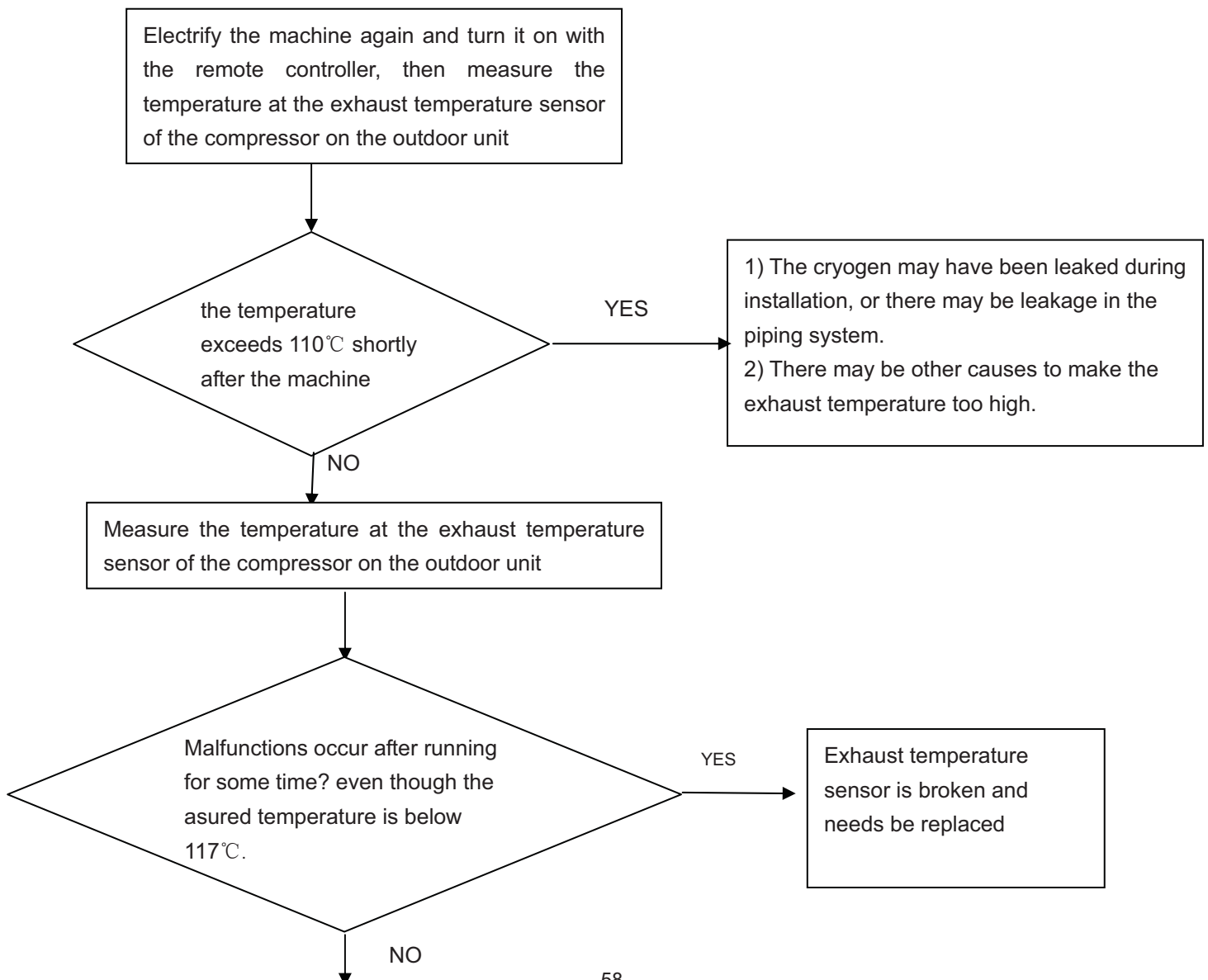

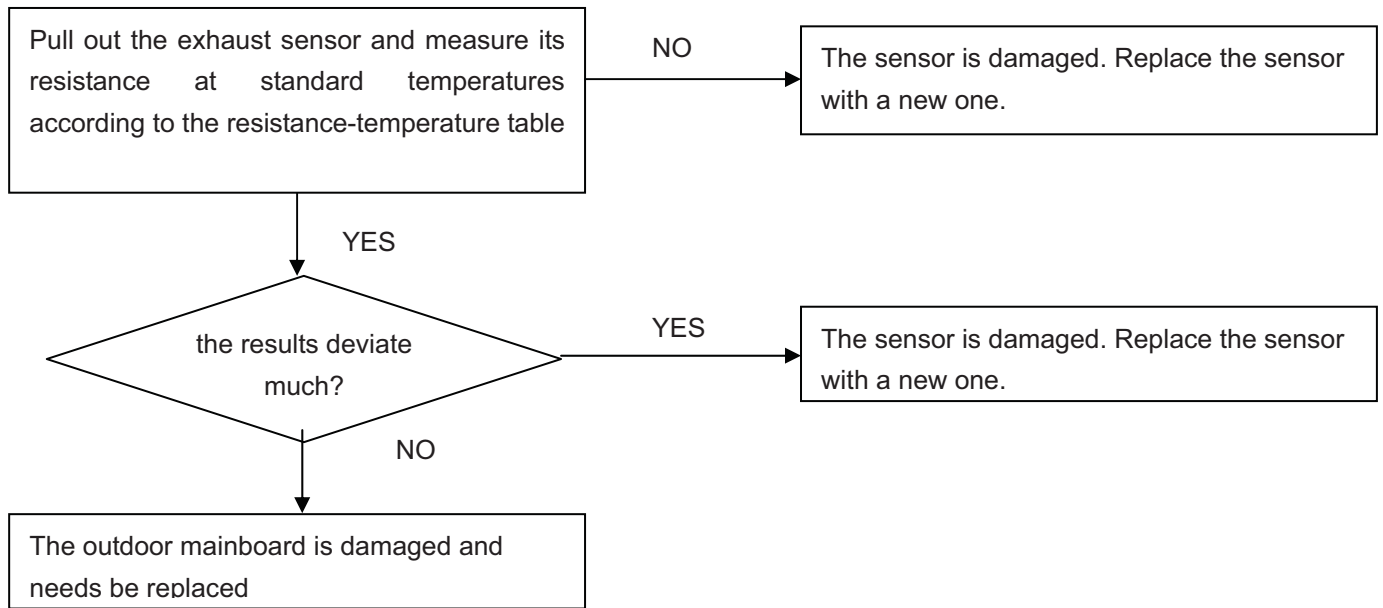

### 7.3.7 The EEPROM Abnormality (Indoor or outdoor unit)

<b>Indoor Display</b>	<b>E4:</b> : Indoor EEPROM error <b>F12:</b> Outdoor EEPROM error
<b>Method of Malfunction Detection</b>	the Data detected by the EEPROM are used to determine MCU
<b>Malfunction Decision Conditions</b>	when the Data of EEPROM is error or the EEPROM is damaged
<b>Supposed Causes</b>	<ul style="list-style-type: none"> <li>■ Faulty EEPROM data</li> <li>■ Faulty EEPROM</li> <li>■ Faulty PCB</li> </ul>

**Troubleshooting** \* **Caution** Be sure to turn off power switch before connect or disconnect connector, or parts damage may be occurred.

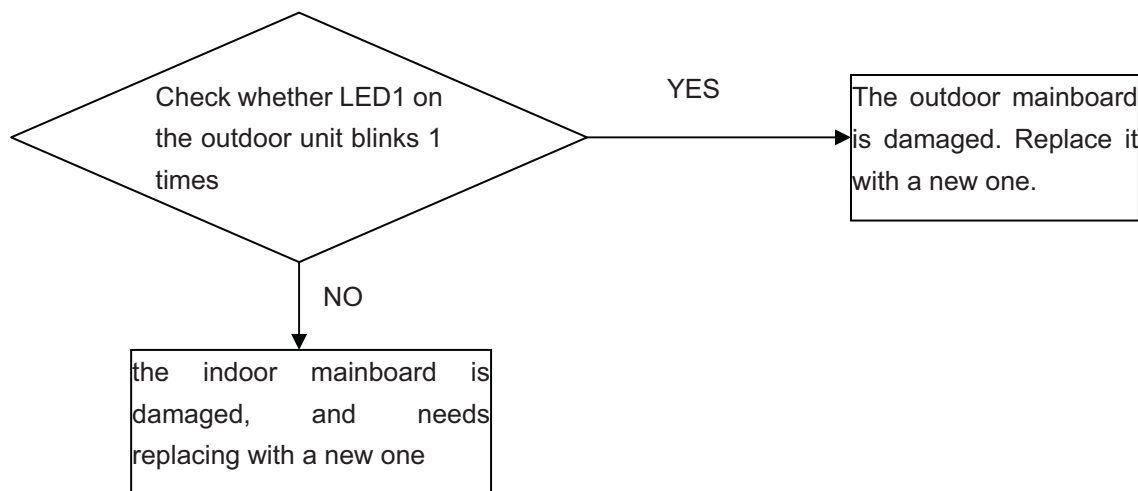

### 7.3.8 Communication error between the indoor and outdoor units

<b>Indoor display</b>	<b>E7;</b>
<b>Outdoor display:</b>	LED1 flash 15 times
<b>Method of Malfunction Detection</b>	The data received from the another unit in indoor unit-outdoor unit signal transmission is checked whether is normal
<b>Malfunction Decision Conditions</b>	When the data sent from the another unit cannot be received normally, or when the content of the data is abnormal
<b>Supposed Causes</b>	<ul style="list-style-type: none"> <li>■ indoor unit- outdoor unit signal transmission error due to wiring error</li> <li>■ Faulty PCB</li> </ul>

**Troubleshooting** \* **Caution** Be sure to turn off power switch before connect or disconnect connector, or else parts damage may be occurred.

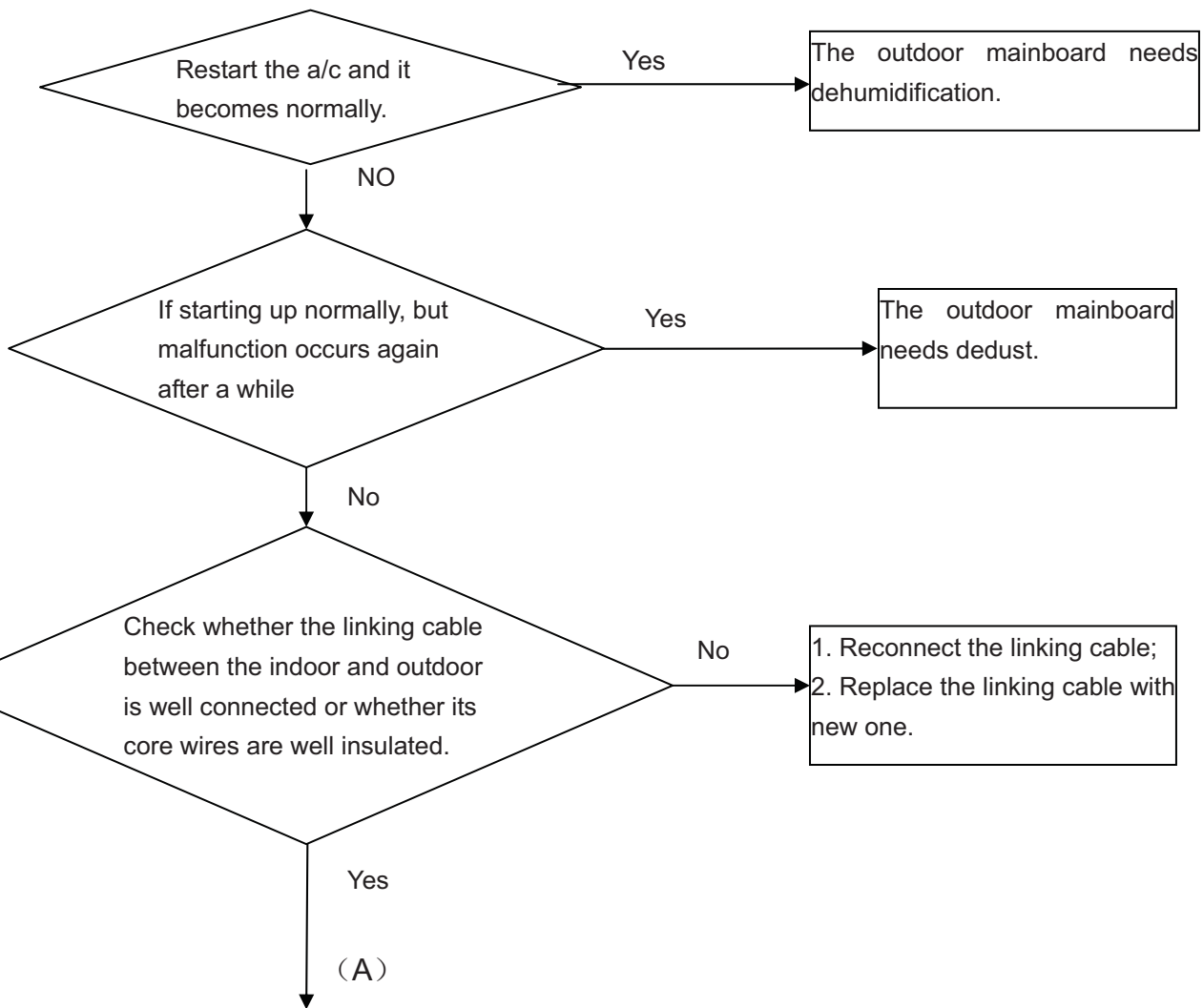

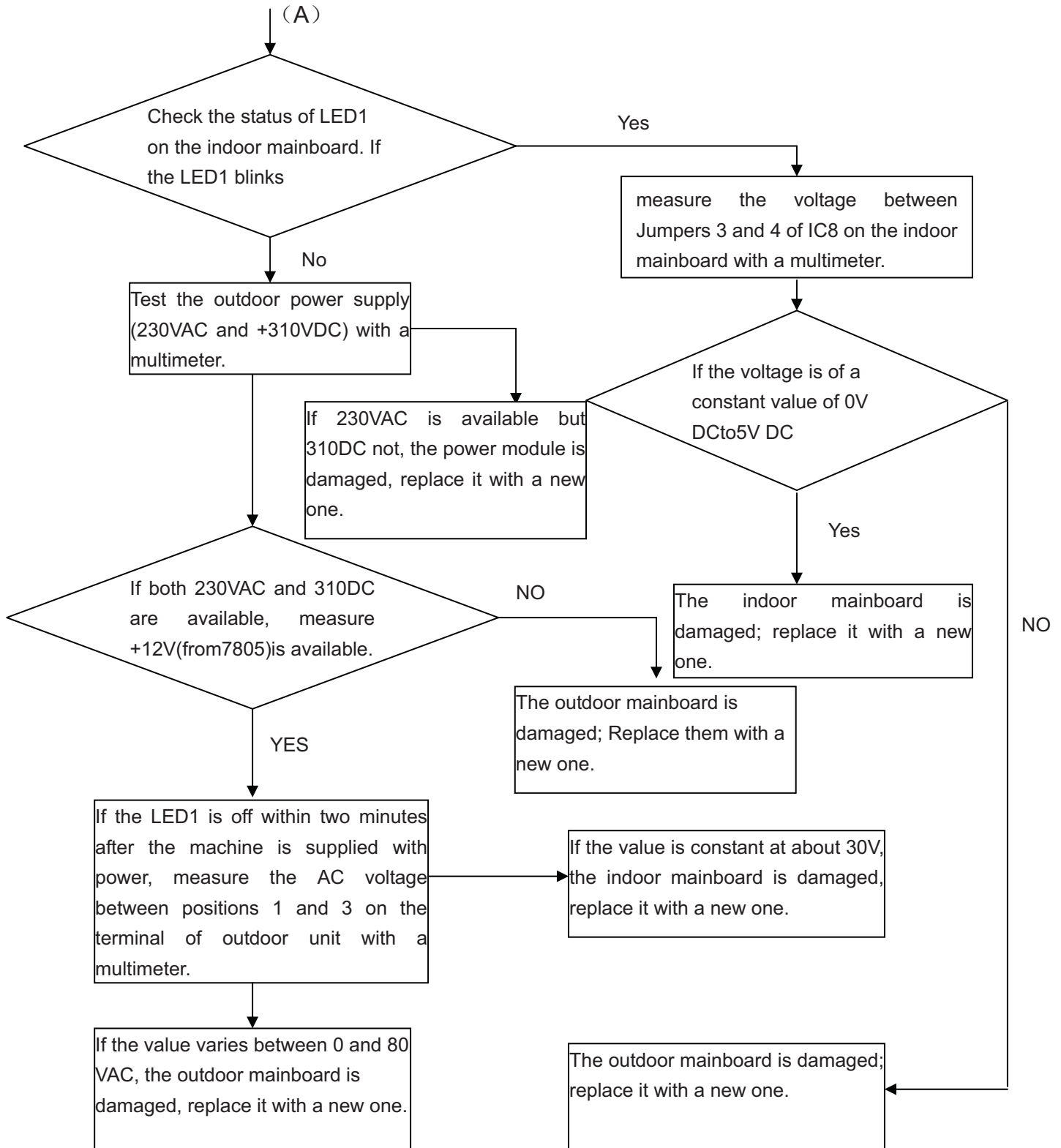



### 7.3.10 Power Supply Over or under voltage fault

<b>Indoor display</b>	<b>F19</b>
<b>outdoor display:</b>	LED1 flash 6 times
<b>Method of circuit.</b>	An abnormal voltage rise or fall is detected by checking the specified voltage detection
<b>Malfunction Detection</b>	
<b>Malfunction Decision Conditions</b>	An voltage signal is fed from the voltage detection circuit to the microcomputer
<b>Supposed Causes</b>	<ul style="list-style-type: none"> <li>■ Supply voltage not as specified</li> <li>■ the IPM module is broken</li> <li>■ the outdoor PCB is broken</li> </ul>
<b>Troubleshooting</b>	<p><b>* Caution</b> Be sure to turn off power switch before connect or disconnect connector, or else parts damage may be occurred.</p>

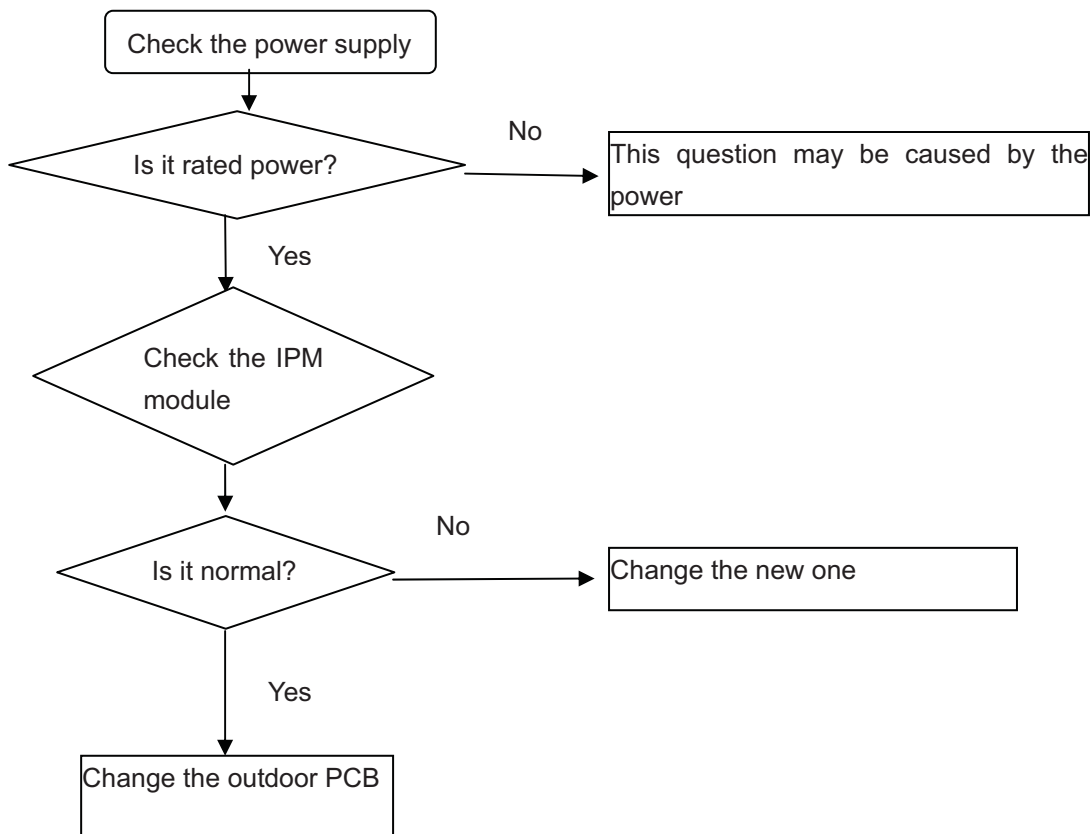

About how to check the IPM module, please refer to IPM protection fault

### 7.3.11 Loop of the station detect error

<b>Outdoor Display</b>	LED1 flash 18 times	<b>Indoor Display</b>	F11
	LED1 flash 19 times	<b>Indoor Display</b>	F28

**Method of Malfunction Detection** the position of the compressor rotor can not detected normally

**Malfunction Decision Conditions** when the The wiring of compressor is wrong or the connection is poor; or the compressor is damaged

- Supposed Causes**
- Faulty The wiring of compressor
  - Faulty compressor
  - Faulty PCB

**Troubleshooting** \* **Caution** Be sure to turn off power switch before connect or disconnect connector, or parts damage may be occurred.

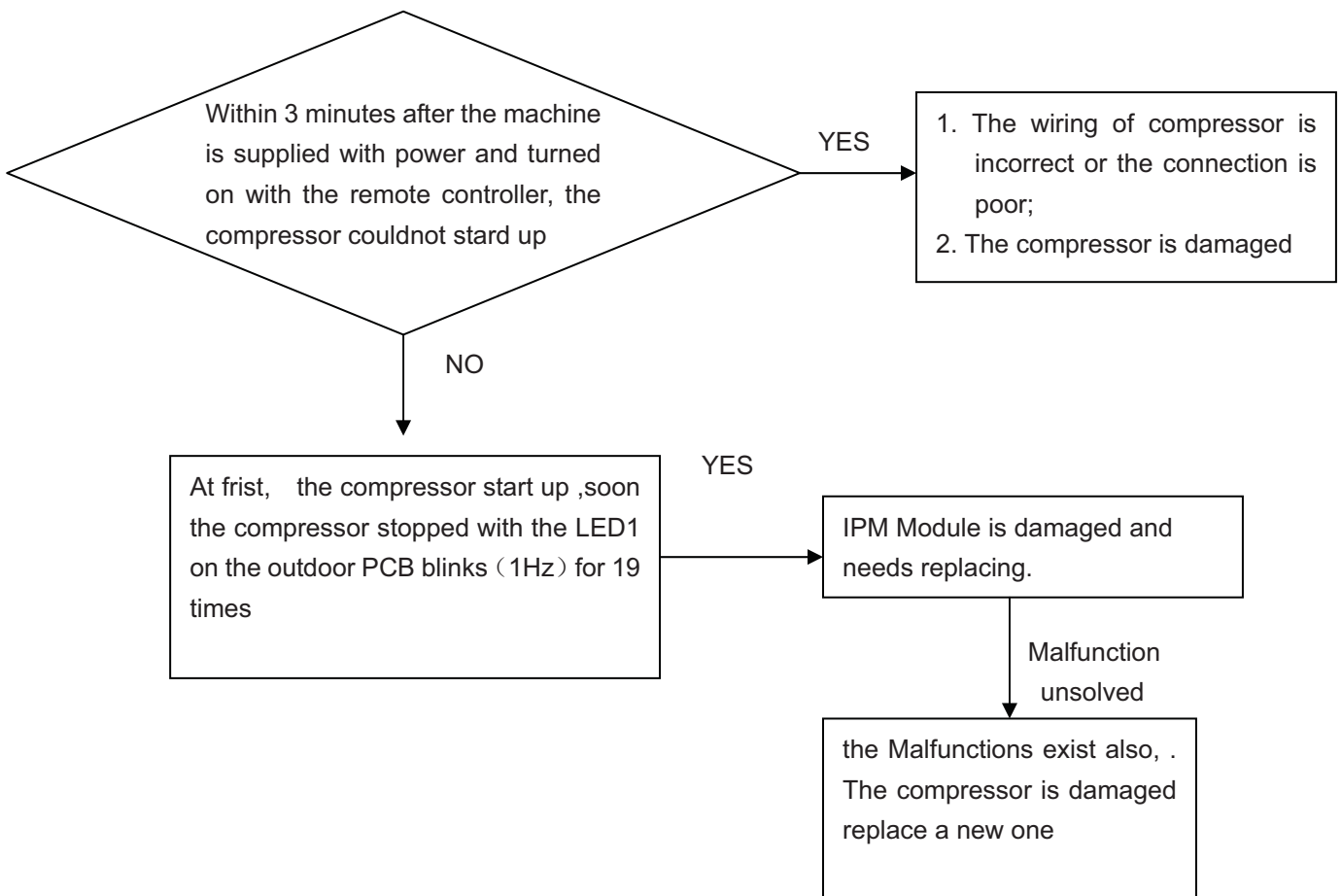

### 7.3.12 Over-current of the compressor

<b>Outdoor Display</b>	LED1 flash 3 or 24 or 25 times
<b>Method of Malfunction Detection</b>	The current of the compressor is too high
<b>Malfunction Decision Conditions</b>	when the IPM Module is damaged or the compressor is damaged power supply. voltage is too low or too high
<b>Supposed Causes</b>	<ul style="list-style-type: none"> <li>■ Faulty IPM Module</li> <li>■ Faulty compressor</li> <li>■ Faulty power supply</li> </ul>

**Troubleshooting** \* **Caution** Be sure to turn off power switch before connect or disconnect connector, or parts damage may be occurred.

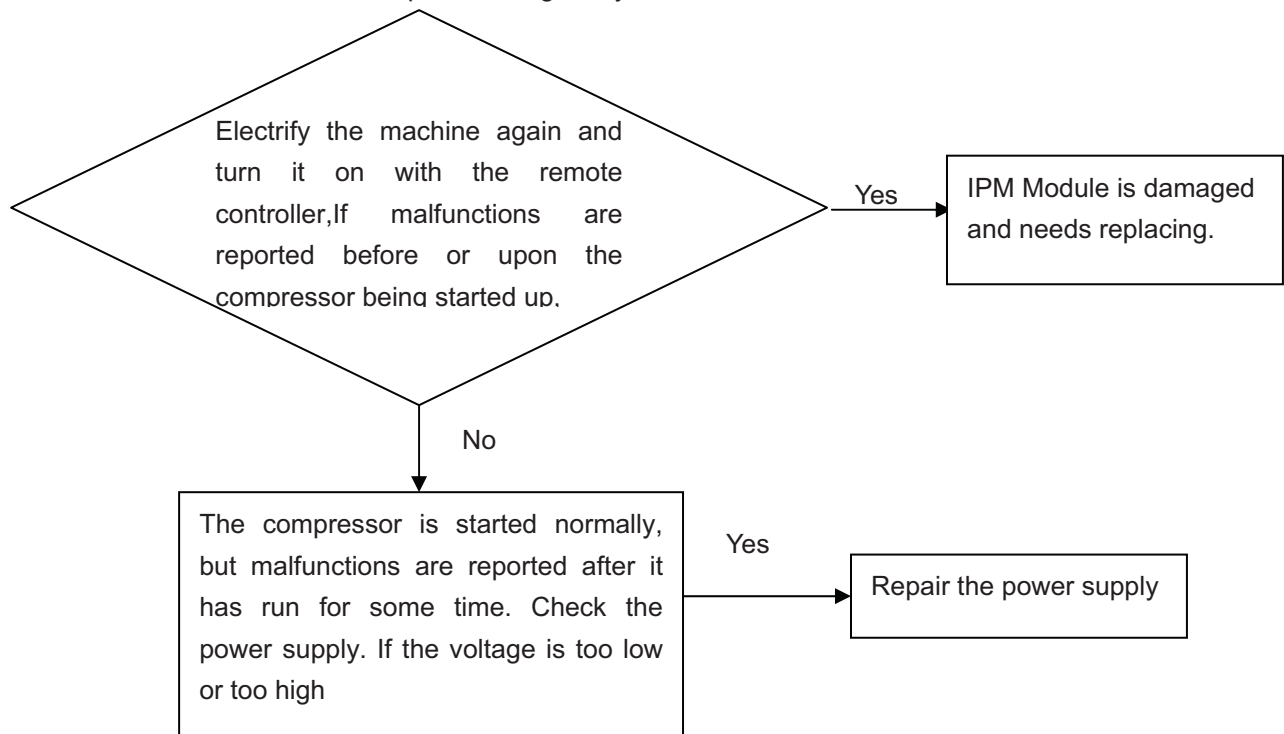

### 7.3.13 Fan Motor(DC Motor) or Related Abnormality

Indoor Display LED1 flash 9 times

<b>Method of determine Malfunction Detection</b>	The rotation speed detected by the Hall IC during fan motor operation is used to abnormal fan motor operation
<b>Malfunction Decision Conditions</b>	when the detected rotation feedback signal don't received in 2 minutes
<b>Supposed Causes</b>	<ul style="list-style-type: none"> <li>■ Operation halt due to short circuit inside the fan motor winding.</li> <li>■ Operation halt due to breaking of wire inside the fan motor .</li> <li>■ Operation halt due to breaking of the fan motor lead wires</li> <li>■ Dedection error due to faulty indoor unit PCB</li> </ul>

#### How to check Fan Motor (DC)

1. Check connector connection.
2. Check motor power supply voltage output (pins 4-7).
3. Check motor control voltage (pins 4-3).
4. Check rotation command voltage output (pins 4-1).
5. Check rotation pulse input (pins 4-2).

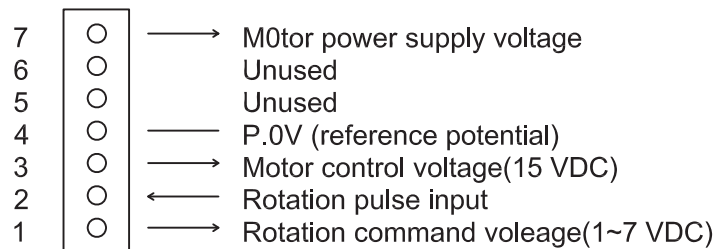

Notes:the a/c is electrifying,don't pull out or insert the terminals of the motor,else the motor would be damaged

**Troubleshooting** \* **Caution** Be sure to turn off power switch before connect or disconnect connector, or parts damage may be occurred.

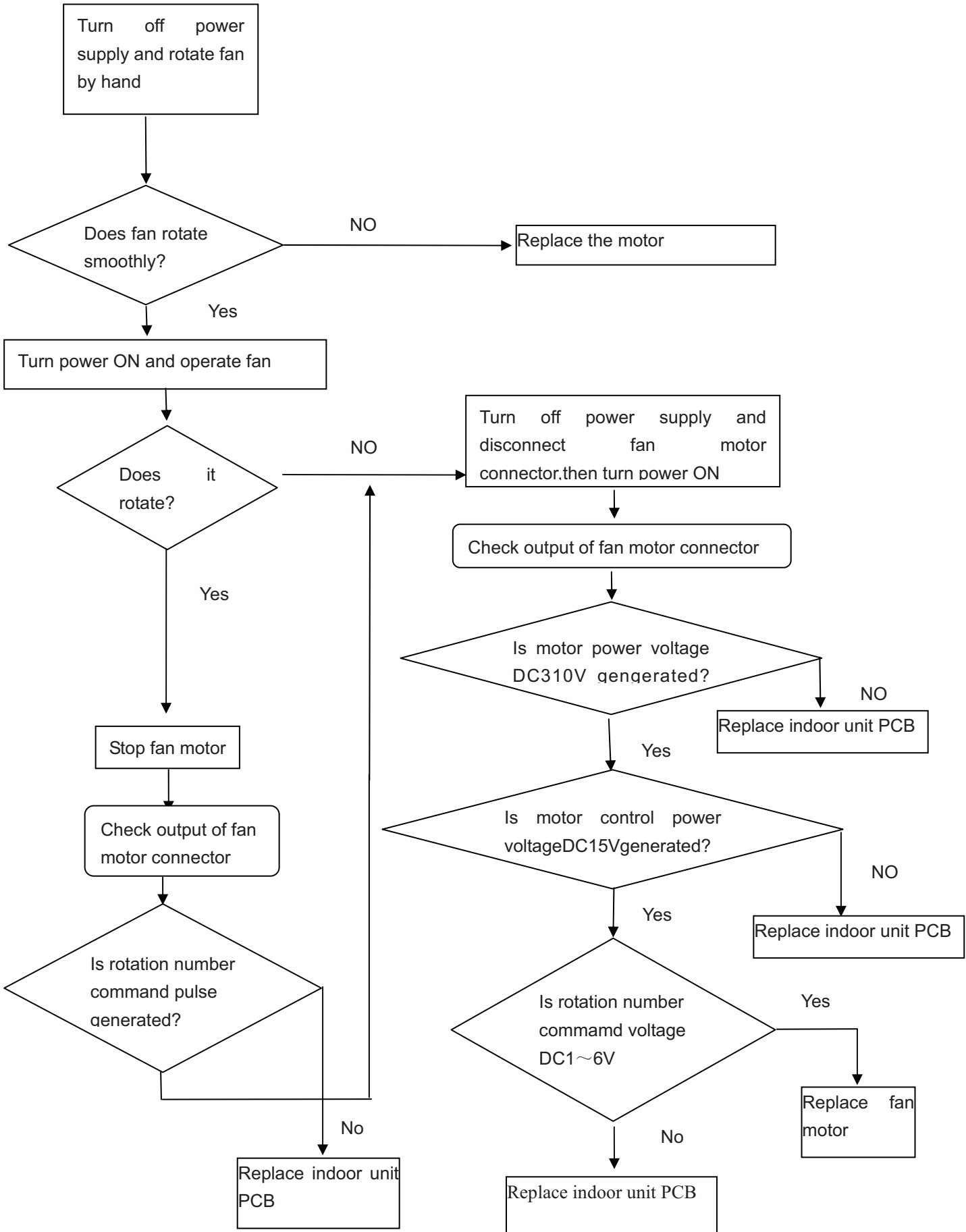

# 10.Wiring Diagrams

## 10.1. INDOORUNIT

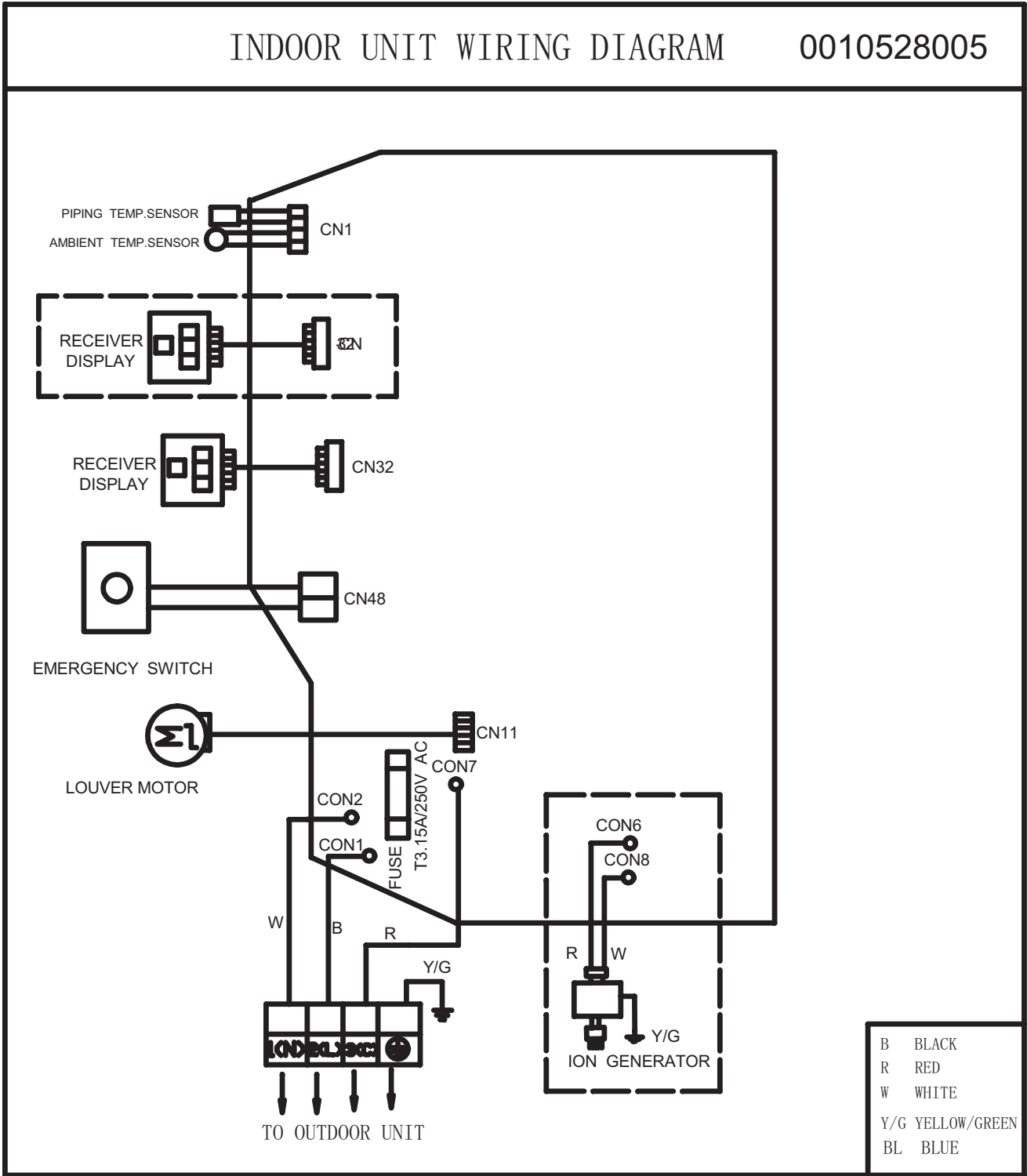

# 10.2.Outdoor unit

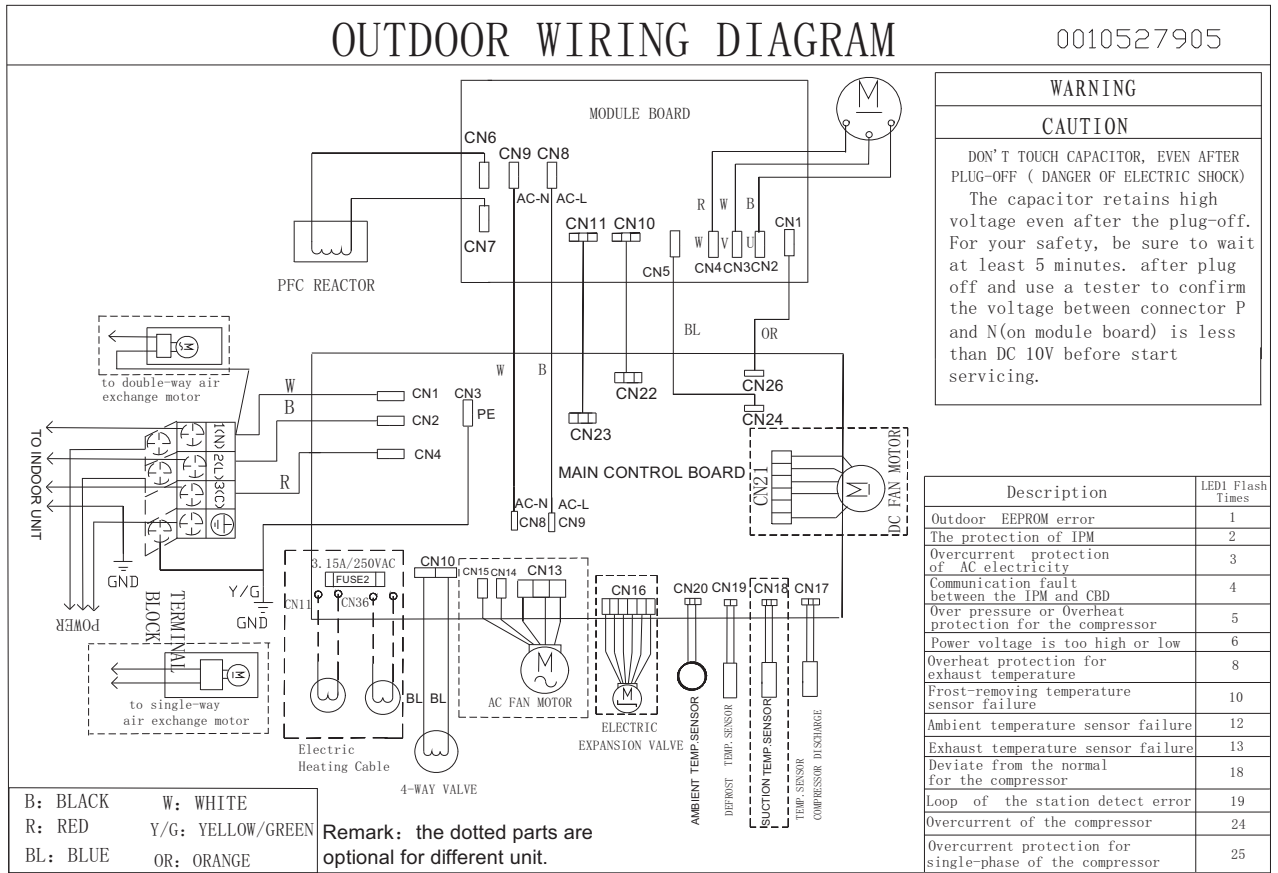





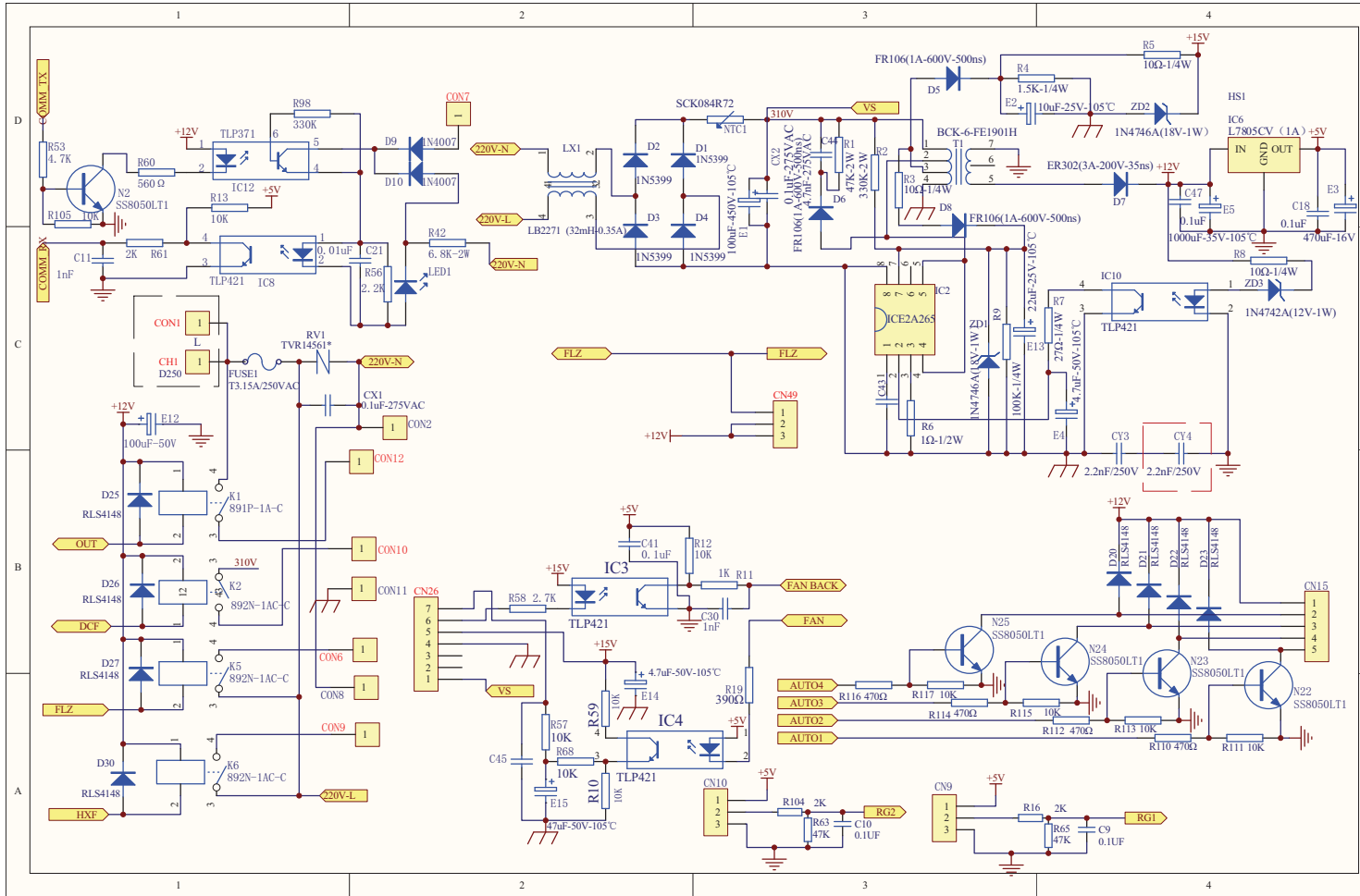

# 11.2.OUTDOORUNIT

## 11.2.1 module board Circuit Diagrams

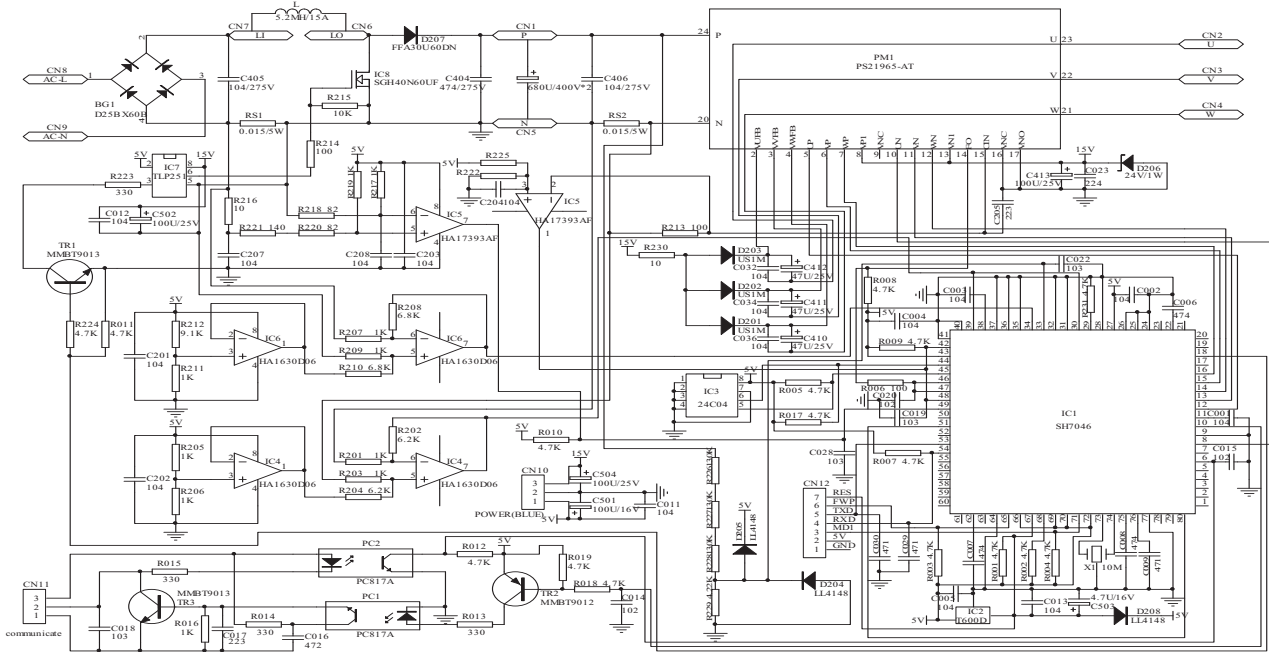

## 11.2.2 control board Circuit Diagrams

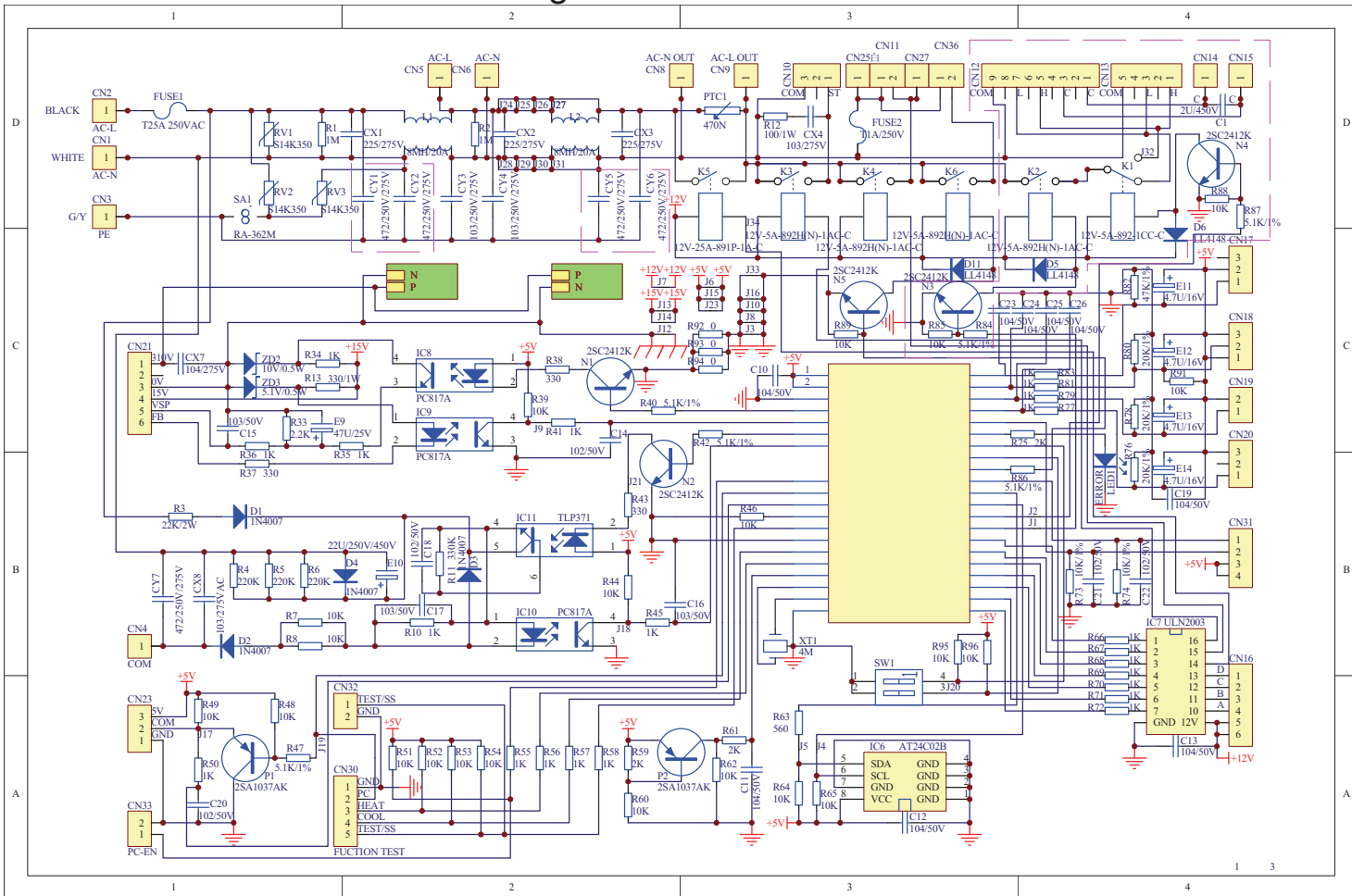

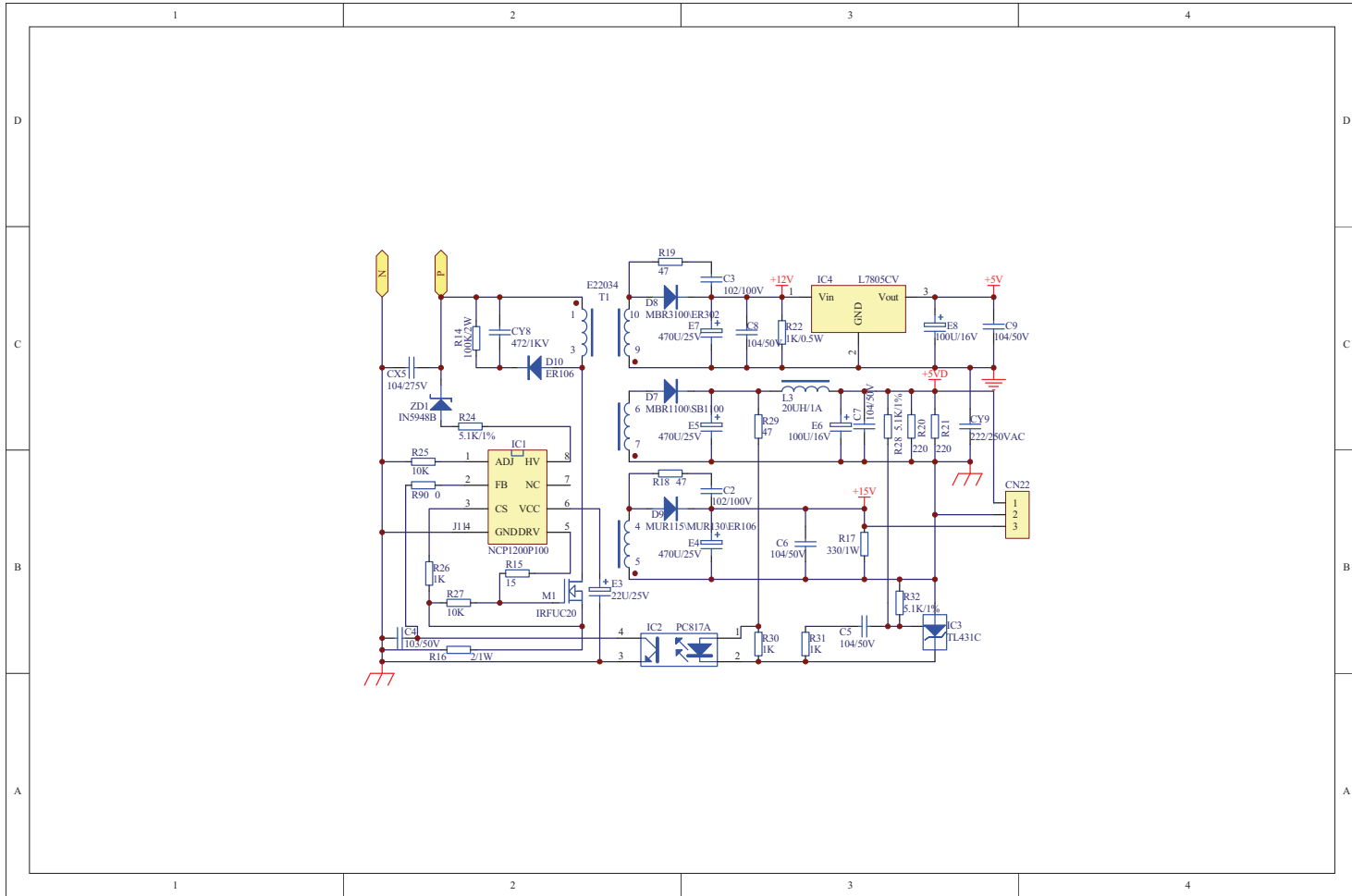

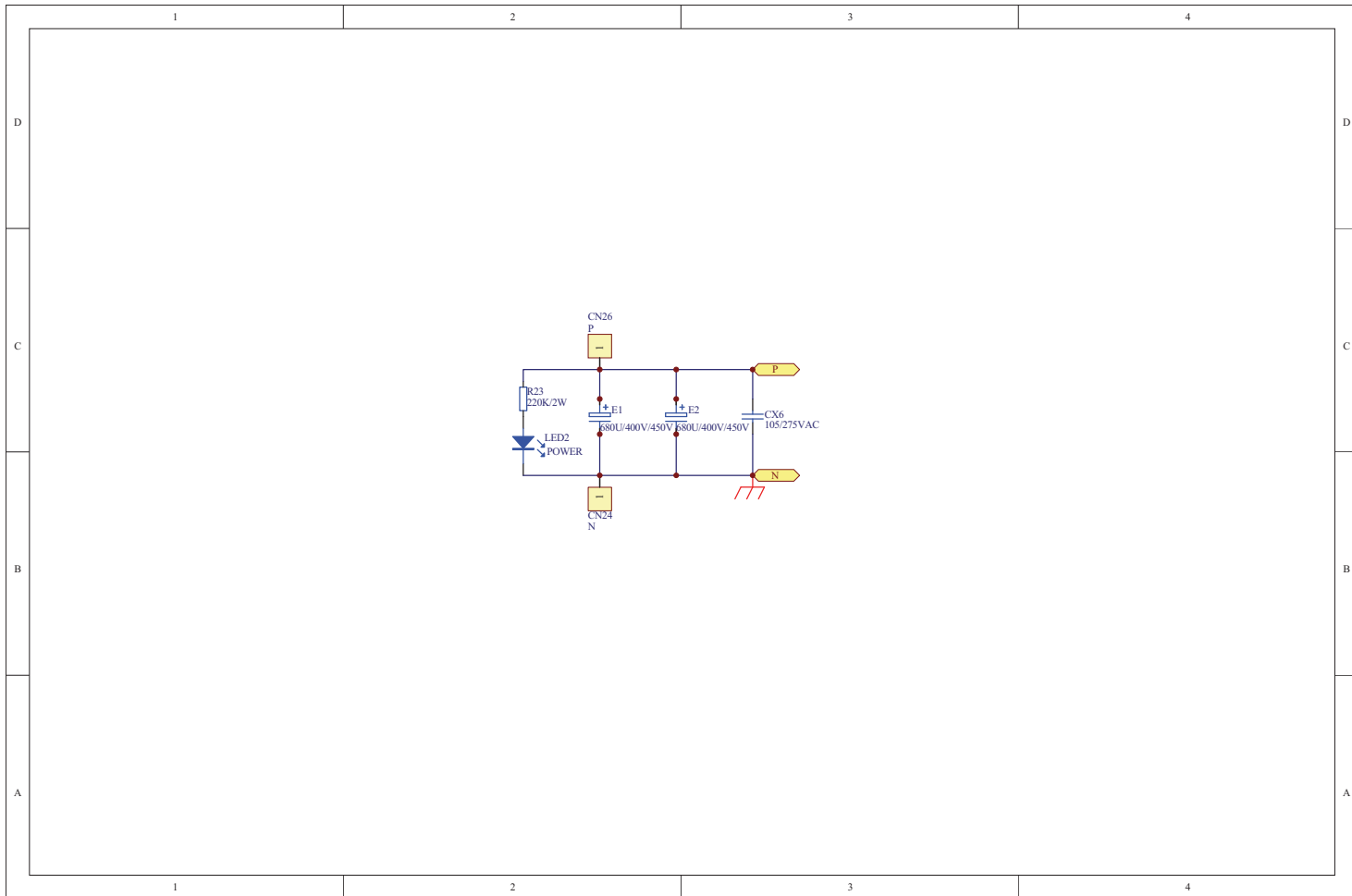

## 12. Description of coding rules of unit model

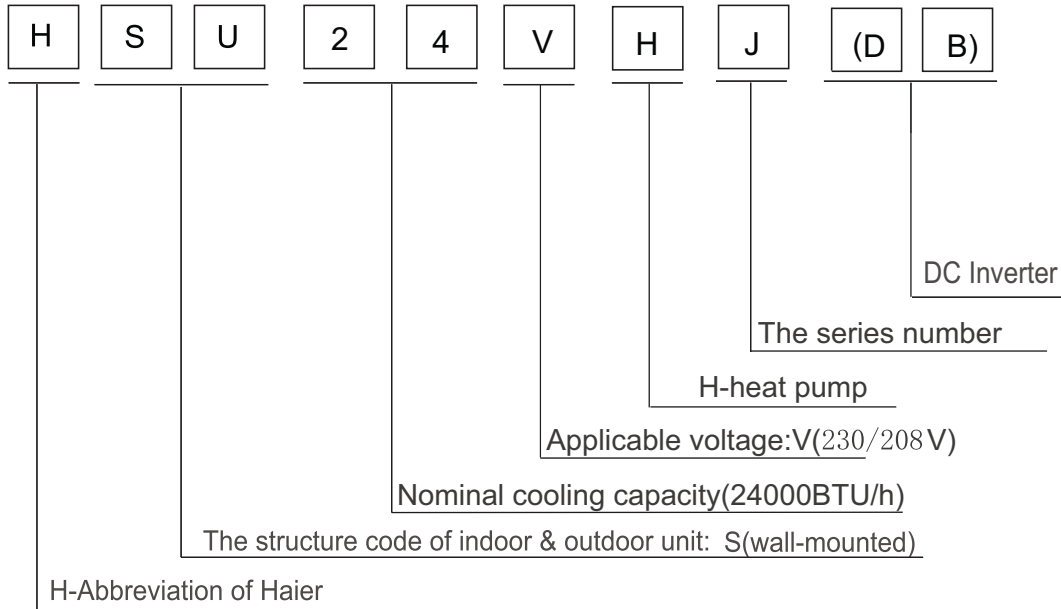

Examples:

HSU-07RD03/R1, It represents wall-mounted split type heat pump air conditioner. The cooling capacity is 7000BTU/h, and the power supply is 220-230V/50Hz, "D" means the developing sequence, and "R1" means the refrigerant is R407C.

# Sincere Forever

## Haier Group

---

Haier Industrial Park, No.1, Haier Road

266101, Qingdao, China\_

E-mail: [hractech@haier.com](mailto:hractech@haier.com)

Tel: +86 532 88936935

[Http://www.haier.com](http://www.haier.com)

Edited by : Li Jingsheng  
Cui Xiaogao

Signed by : Yang Bifei

Approved by: W u Hongjin