

FEATURES

Reliable low cost voltage monitor with reset output

Suitable for monitoring 2.5 V, 3 V, 3.3 V, and 5 V power supply voltages

Reset threshold levels: 4.62 V, 4.35 V, 3.06 V, 2.88 V, 2.55 V, 2.31 V, and 2.18 V typical

Active high and low push-pull output choices: [ADM1810](#), [ADM1812](#), [ADM1815](#), and [ADM1817](#)

Open-drain with internal pull-up resistor output choices: [ADM1811](#), [ADM1813](#), [ADM1816](#), and [ADM1818](#)

Can be used with a manual push-button to generate a reset: [ADM1813](#), [ADM1818](#)

Initialization of microprocessor systems with added safety

Available in 3-lead SOT-23 and SC70 packages

APPLICATIONS

Microprocessor systems

Computers

Controllers

Intelligent instruments

Automotive systems

GENERAL DESCRIPTION

The [ADM181x](#) range of voltage monitoring circuits is used in any application where an electronic system needs to be reset when a voltage increases above or below a predetermined value.

Because of the reset delay time incorporated into the [ADM181x](#) series, these devices provide a safe startup for electronic systems.

Before a system initializes, the power supply must stabilize.

Using the [ADM181x](#) series ensures that there are typically 150 ms for the power supply to stabilize before the system resets and safe system initialization begins.

The [ADM181x](#) series of microprocessor reset circuits are available in low cost, space-saving SOT-23 and SC70 packages.

FUNCTIONAL BLOCK DIAGRAMS

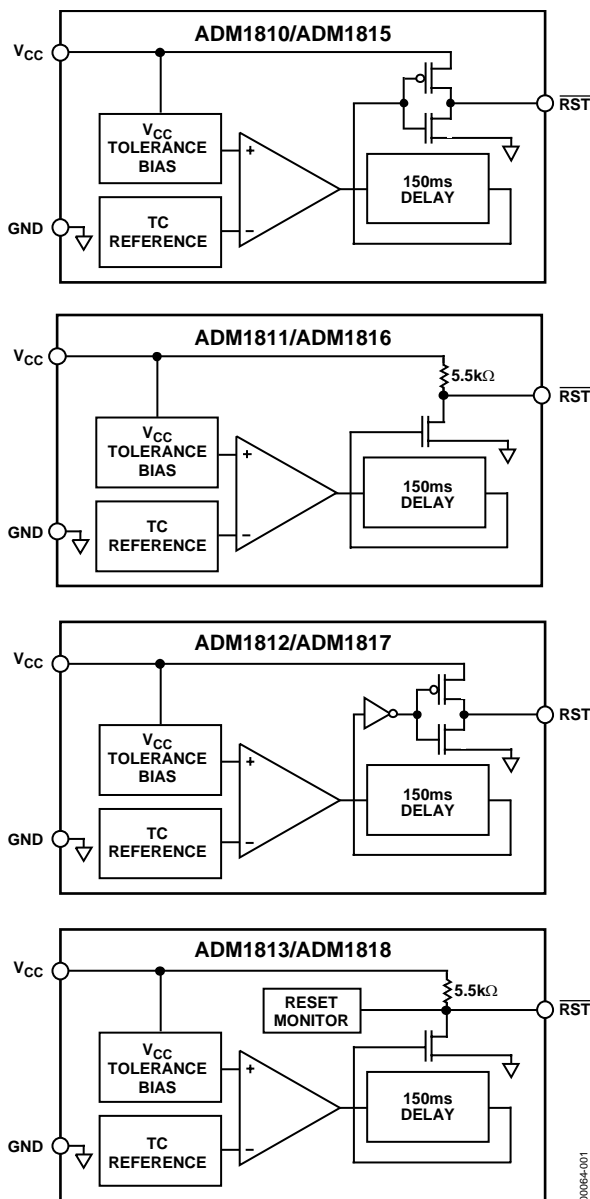

Figure 1.

TABLE OF CONTENTS

Features	1	Typical Performance Characteristics	6
Applications.....	1	Theory of Operation	7
General Description	1	Timing Diagrams for All Devices	7
Functional Block Diagrams.....	1	ADM1813 and ADM1818	7
Revision History	2	ADM1810, ADM1812, ADM1815, and ADM1817	7
Specifications.....	3	ADM1811 and ADM1816	7
Absolute Maximum Ratings.....	4	Outline Dimensions	8
ESD Caution.....	4	Ordering Guide	9
Pin Configurations and Function Descriptions	5		

REVISION HISTORY

10/13—Rev. E to Rev. F

Changed Open-Drain to Open-Drain with Internal Pull-Up Resistor	Throughout
Updated Outline Dimensions	8
Changes to Ordering Guide	9

8/08—Rev. D to Rev. E

Changes to Table 3.....	5
Updated Outline Dimensions	8
Changes to Ordering Guide	9

10/05—Rev. C to Rev. D

Updated Format.....	Universal
Added Figure 3.....	5
Changes to Table 3.....	5
Updated Outline Dimensions	8
Edits to Ordering Guide	9

9/03—Rev. B to Rev. C.

Added SC70.....	Universal
Edits to Specifications	2
Edits to Ordering Guide	4
Updated Outline Dimensions	7

2/03—Rev. A to Rev. B.

Edits to Features.....	1
Deleted Table I	1
Edits to Specifications.....	2
Edits to Absolute Maximum Ratings.....	3
Edits to Ordering Guide	3
Added Typical Performance Characteristics	4
Edits to ADM1813 AND ADM1818 section	5
Edits to ADM1810, ADM1812, ADM1815, and ADM1817 Section	5
Edits to ADM1811 and ADM1816 Section	5
Updated Outline Dimensions	6

3/02—Rev. 0 to Rev. A.

Addition of Table	1
Edits to Ordering Guide	3
Addition of New Text to ADM1813 and ADM1818 Section	4

4/99—Revision 0: Initial Version

SPECIFICATIONS

V_{CC} = full operating range, T_A = -40°C to $+105^{\circ}\text{C}$, unless otherwise noted.

Table 1.

Parameter	Min	Typ	Max	Unit	Comments
SUPPLY					
Voltage	1		5.5	V	$T_A = 0^{\circ}\text{C}$ to 105°C
	1.2		5.5	V	$T_A = -40^{\circ}\text{C}$ to $+105^{\circ}\text{C}$
Current		9	16	μA	$V_{CC} = 5.5\text{ V}$, $V_{CC} > V_{TH}$, no load
		4	10	μA	$V_{CC} = 3.6\text{ V}$, $V_{CC} > V_{TH}$, no load
OUTPUT CURRENT					
$\overline{\text{RST}}$ Output Source Current		350		μA	$V_{CC} \geq V_{TH}$ (max), reset not asserted (ADM1810/ADM1815)
RST Output Source Current		350		μA	$V_{CC} \leq V_{TH}$ (min), reset asserted (ADM1812/ADM1817)
$\overline{\text{RST}}$ Output Sink Current	8			mA	$V_{CC} \geq 2.7\text{ V}$, reset asserted, $V_{OUT} = 0.4\text{ V}$ (ADM1810/ADM1811/ADM1813/ADM1815/ADM1816/ADM1818)
RST Output Sink Current	8			mA	$V_{CC} \geq 2.7\text{ V}$, reset not asserted, $V_{OUT} = 0.4\text{ V}$ (ADM1812/ADM1817)
OUTPUT VOLTAGE	$V_{CC} - 0.5$	$V_{CC} - 0.1$		V	ADM1810/ADM1812/ADM1815/ADM1817 at $0\ \mu\text{A}$ to $500\ \mu\text{A}$
V_{CC} TRIP POINT					
ADM1810-5, ADM1811-5, ADM1812-5, ADM1813-5	4.50	4.62	4.75	V	
ADM1810-10, ADM1811-10, ADM1812-10, ADM1813-10	4.25	4.35	4.49	V	
ADM1815-5, ADM1816-5, ADM1817-5, ADM1818-5	2.98	3.06	3.15	V	
ADM1815-10, ADM1816-10, ADM1817-10, ADM1818-10	2.80	2.88	2.97	V	
ADM1815-20, ADM1816-20, ADM1817-20, ADM1818-20	2.47	2.55	2.64	V	
ADM1815-R23, ADM1816-R23, ADM1817-R23, ADM1818-R23	2.25	2.31	2.37	V	
ADM1815-R22, ADM1816-R22, ADM1817-R22, ADM1818-R22	2.12	2.18	2.25	V	
INTERNAL PULL-UP RESISTOR					
ADM1811/ADM1816	3.5	5.5	7.5	k Ω	
ADM1813/ADM1818	3.1	5.5	7.5	k Ω	
OUTPUT CAPACITANCE			10	pF	
RESET ACTIVE TIME	100	150	250	ms	
V_{CC} DETECT TO RESET					
Falling		10		μs	
Rising	100	150	250	ms	$t_R = 5\ \mu\text{s}$
PUSH-BUTTON DETECT TO $\overline{\text{RST}}$	1			μs	ADM1813/ADM1818
PUSH-BUTTON RESET	100	150	250	ms	ADM1813/ADM1818

ABSOLUTE MAXIMUM RATINGS

$T_A = 25^\circ\text{C}$, unless otherwise noted.

Table 2.

Parameter	Rating
V_{CC}	-0.3 V to +6.0 V
Input Current	20 mA
Operating Temperature Range	-40°C to +105°C
Storage Temperature Range	-65°C to +150°C
θ_{JA} Thermal Impedance, SOT-23	270°C/W
θ_{JA} Thermal Impedance, SC70	146°C/W
Lead Temperature (Soldering, 10 sec)	300°C
Vapor Phase (60 sec)	215°C
Infrared (15 sec)	220°C

Stresses above those listed under Absolute Maximum Ratings may cause permanent damage to the device. This is a stress rating only; functional operation of the device at these or any other conditions above those indicated in the operational section of this specification is not implied. Exposure to absolute maximum rating conditions for extended periods may affect device reliability.

ESD CAUTION



ESD (electrostatic discharge) sensitive device. Charged devices and circuit boards can discharge without detection. Although this product features patented or proprietary protection circuitry, damage may occur on devices subjected to high energy ESD. Therefore, proper ESD precautions should be taken to avoid performance degradation or loss of functionality.

PIN CONFIGURATIONS AND FUNCTION DESCRIPTIONS

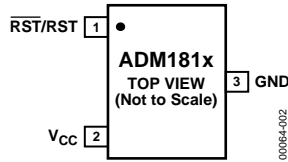

Figure 2. 3-Lead SOT-23 Pin Configuration

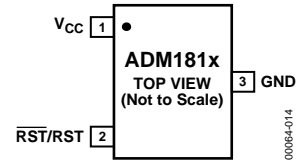

Figure 3. 3-Lead SC70 Pin Configuration

Table 3. Pin Function Descriptions

Pin No.		Mnemonic	Description
SOT-23	SC70		
1	2	RST	Active High Reset Output. RST remains high while V_{CC} is below the reset threshold and remains high for 150 ms typical after V_{CC} rises above the reset threshold. Applies to the ADM1812 and ADM1817 only.
		$\overline{\text{RST}}$	Active Low Reset Output. $\overline{\text{RST}}$ remains low while V_{CC} is below the reset threshold and remains low for 150 ms typical after V_{CC} rises above the reset threshold. Applies to the ADM1810 , ADM1811 , ADM1813 , ADM1815 , ADM1816 , and ADM1818 only.
2	1	V_{CC}	Supply Voltage. The supply voltage being monitored.
3	3	GND	Ground. 0 V ground reference for all signals.

TYPICAL PERFORMANCE CHARACTERISTICS

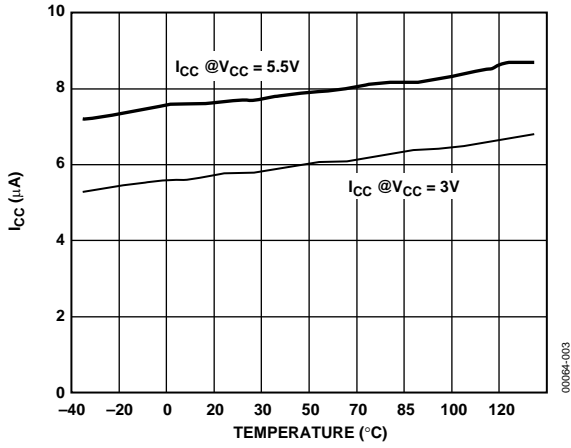

Figure 4. Supply Current vs. Temperature

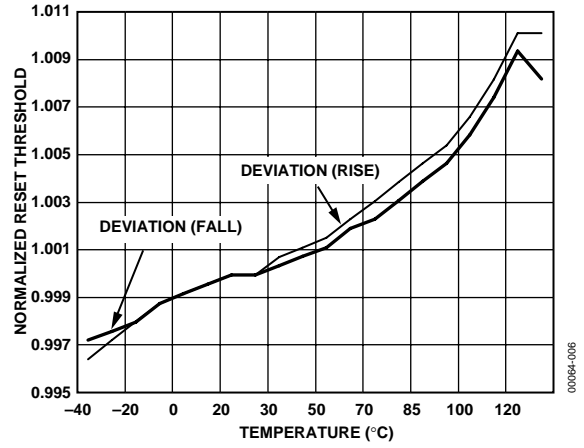

Figure 7. Normalized Reset Threshold vs. Temperature

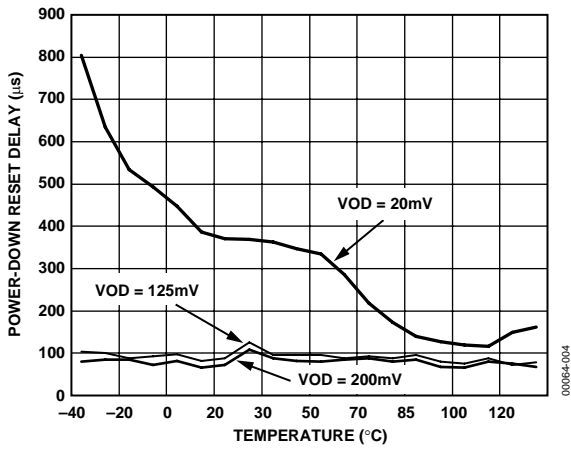

Figure 5. Power-Down Reset Delay vs. Temperature

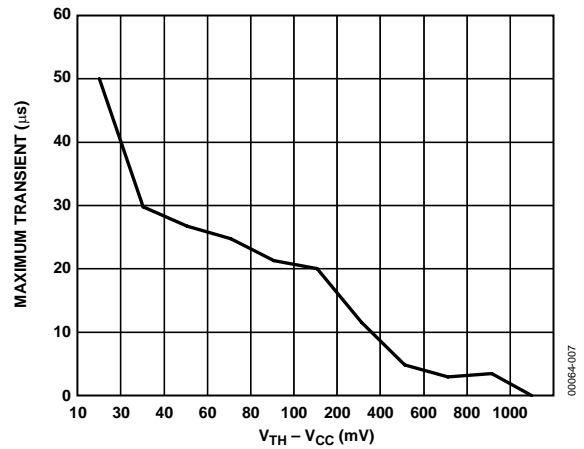

Figure 8. Maximum Transient Duration Without Causing a Reset Pulse vs. Reset Comparator Overdrive

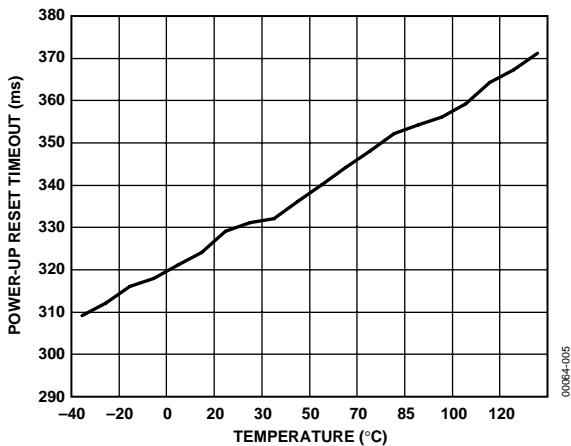

Figure 6. Power-Up Reset Timeout vs. Temperature

THEORY OF OPERATION

TIMING DIAGRAMS FOR ALL DEVICES

The following two timing diagrams are valid for [ADM1810](#), [ADM1811](#), [ADM1812](#), [ADM1813](#), [ADM1815](#), [ADM1816](#), [ADM1817](#), and [ADM1818](#).

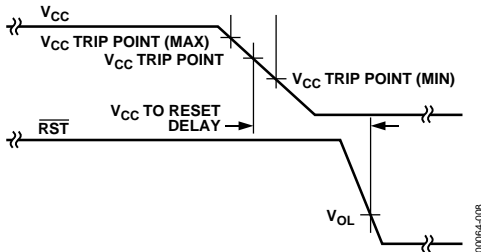

Figure 9. Power-Down Timing Diagram

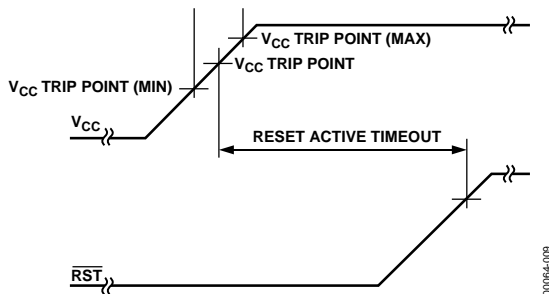

Figure 10. Power-Up Timing Diagram

ADM1813 AND ADM1818

The [ADM1813](#) and [ADM1818](#) are low cost voltage monitoring devices featuring an open-drain with internal pull-up resistor output and optional push-button reset function.

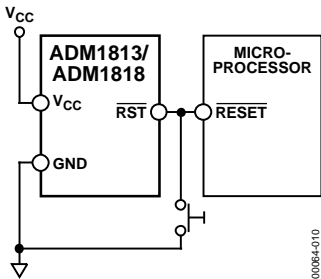

Figure 11. [ADM1813/ADM1818](#) Typical Application

An optional push-button reset switch can be connected between $\overline{\text{RST}}$ and ground. Pressing this switch pulls the reset output low. If the push-button reset button pulls the $\overline{\text{RST}}$ output low for a period greater than $1 \mu\text{s}$ when the reset button releases the $\overline{\text{RST}}$ line to float high, then the $\overline{\text{RST}}$ line stays low for another 150 ms typical.

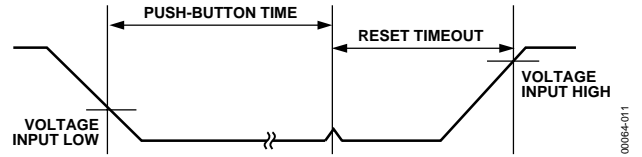

Figure 12. Push-Button Reset Timing Diagram

The [ADM1818](#) range has 2.88 V and 2.55 V (typical) trip point options that allow the user to monitor 3.3 V and 3 V supplies. For 5 V monitoring requirements, the [ADM1813](#) range has 4.62 V and 4.35 V (typical) trip point options.

ADM1810, ADM1812, ADM1815, AND ADM1817

The [ADM1812](#) is a 5 V supply monitor with an active high push-pull output and trip point options of 4.62 V and 4.35 V typical. The [ADM1810](#) is similar to the [ADM1812](#), except that the [ADM1810](#) has an active low push-pull output stage. The [ADM1817](#) is suitable for monitoring 3.3 V, 3 V, and 2.5 V supplies, with an active high push-pull output and trip point options of 3.06 V, 2.88 V, 2.55 V, 2.31 V, and 2.18 V typical. The [ADM1815](#) is similar to the [ADM1817](#), except that the [ADM1815](#) has an active low push-pull output stage.

The [ADM1810/ADM1812/ADM1815/ADM1817](#) can connect directly to most microprocessor reset inputs without the need for external components.

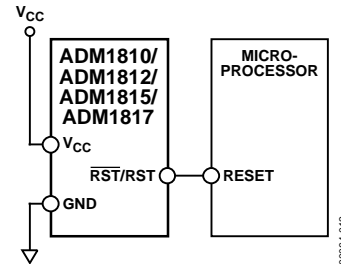

Figure 13. [ADM1810/ADM1812/ADM1815/ADM1817](#) Typical Application

ADM1811 AND ADM1816

The [ADM1811](#) is a 5 V supply monitor with an active low open-drain with internal pull-up resistor output and trip point options of 4.62 V and 4.35 V typical. The [ADM1816](#) also has an active low open-drain with internal pull-up resistor output but is suitable for monitoring lower voltage supplies of 3.3 V, 3 V, and 2.5 V.

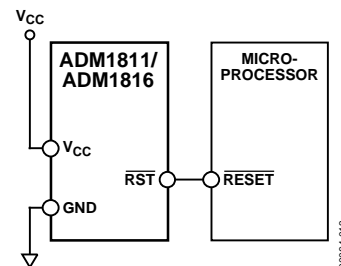
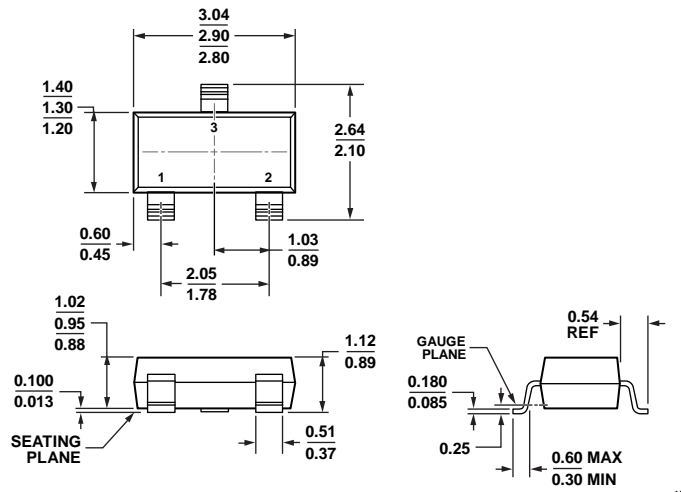

Figure 14. [ADM1811/ADM1816](#) Typical Application

OUTLINE DIMENSIONS



COMPLIANT TO JEDEC STANDARDS TO-236-AB

Figure 15. 3-Lead Small Outline Transistor Package [SOT-23] (RT-3)

Dimensions shown in millimeters

011909-C

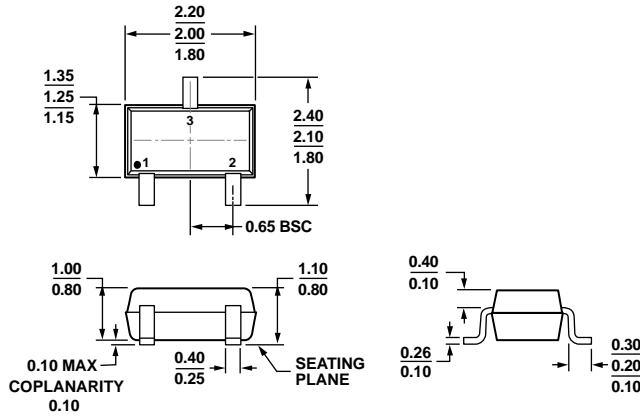

ALL DIMENSIONS COMPLIANT WITH EIAJ SC70

Figure 16. 3-Lead Thin Shrink Small Outline Transistor Package [SC70] (KS-3)

Dimensions shown in millimeters

072809-A

ORDERING GUIDE

Model ^{1, 2}	Temperature Range	Trip Point	Package Option	Branding
ADM1810-5AKSZ-REEL	-40°C to +105°C	4.62 V	KS-3 (SC70)	M4Y
ADM1810-5AKSZ-RL7	-40°C to +105°C	4.62 V	KS-3 (SC70)	M4Y
ADM1810-5ART-REEL7	-40°C to +105°C	4.62 V	RT-3 (SOT-23)	MZV
ADM1810-5ARTZ-REEL	-40°C to +105°C	4.62 V	RT-3 (SOT-23)	M4Y
ADM1810-5ARTZ-RL7	-40°C to +105°C	4.62 V	RT-3 (SOT-23)	M4Y
ADM1810-10AKS-RL7	-40°C to +105°C	4.35 V	KS-3 (SC70)	MZT
ADM1810-10AKSZ-RL	-40°C to +105°C	4.35 V	KS-3 (SC70)	M4Z
ADM1810-10AKSZ-RL7	-40°C to +105°C	4.35 V	KS-3 (SC70)	M4Z
ADM1810-10ARTZ-RL	-40°C to +105°C	4.35 V	RT-3 (SOT-23)	M4Z
ADM1810-10ARTZ-RL7	-40°C to +105°C	4.35 V	RT-3 (SOT-23)	M4Z
ADM1811-5AKS-RL7	-40°C to +105°C	4.62 V	KS-3 (SC70)	M1V
ADM1811-5AKSZ-REEL	-40°C to +105°C	4.62 V	KS-3 (SC70)	M6Z
ADM1811-5AKSZ-RL7	-40°C to +105°C	4.62 V	KS-3 (SC70)	M6Z
ADM1811-5ART-REEL	-40°C to +105°C	4.62 V	RT-3 (SOT-23)	M1V
ADM1811-5ART-REEL7	-40°C to +105°C	4.62 V	RT-3 (SOT-23)	M1V
ADM1811-5ARTZ-REEL	-40°C to +105°C	4.62 V	RT-3 (SOT-23)	M6Z
ADM1811-5ARTZ-RL7	-40°C to +105°C	4.62 V	RT-3 (SOT-23)	M6Z
ADM1811-10AKS-RL7	-40°C to +105°C	4.35 V	KS-3 (SC70)	M1T
ADM1811-10AKSZ-RL	-40°C to +105°C	4.35 V	KS-3 (SC70)	M70
ADM1811-10AKSZ-RL7	-40°C to +105°C	4.35 V	KS-3 (SC70)	M70
ADM1811-10ART-REEL	-40°C to +105°C	4.35 V	RT-3 (SOT-23)	M1T
ADM1811-10ARTZ-RL	-40°C to +105°C	4.35 V	RT-3 (SOT-23)	M70
ADM1811-10ARTZ-RL7	-40°C to +105°C	4.35 V	RT-3 (SOT-23)	M70
ADM1812-5AKS-RL7	-40°C to +105°C	4.62 V	KS-3 (SC70)	MTV
ADM1812-5AKSZ-REEL	-40°C to +105°C	4.62 V	KS-3 (SC70)	M72
ADM1812-5AKSZ-RL7	-40°C to +105°C	4.62 V	KS-3 (SC70)	M72
ADM1812-5ART-REEL7	-40°C to +105°C	4.62 V	RT-3 (SOT-23)	MTV
ADM1812-5ARTZ-REEL	-40°C to +105°C	4.62 V	RT-3 (SOT-23)	M72
ADM1812-5ARTZ-RL7	-40°C to +105°C	4.62 V	RT-3 (SOT-23)	M72
ADM1812-10AKS-RL7	-40°C to +105°C	4.35 V	KS-3 (SC70)	MTT
ADM1812-10AKSZ-RL	-40°C to +105°C	4.35 V	KS-3 (SC70)	M71
ADM1812-10AKSZ-RL7	-40°C to +105°C	4.35 V	KS-3 (SC70)	M71
ADM1812-10ART-RL7	-40°C to +105°C	4.35 V	RT-3 (SOT-23)	MTT
ADM1812-10ARTZ-RL	-40°C to +105°C	4.35 V	RT-3 (SOT-23)	M71
ADM1812-10ARTZ-RL7	-40°C to +105°C	4.35 V	RT-3 (SOT-23)	M71
ADM1813-5AKS-REEL	-40°C to +105°C	4.62 V	KS-3 (SC70)	M3V
ADM1813-5AKS-RL7	-40°C to +105°C	4.62 V	KS-3 (SC70)	M3V
ADM1813-5AKSZ-REEL	-40°C to +105°C	4.62 V	KS-3 (SC70)	M6X
ADM1813-5AKSZ-RL7	-40°C to +105°C	4.62 V	KS-3 (SC70)	M6X
ADM1813-5ART-RL7	-40°C to +105°C	4.62 V	RT-3 (SOT-23)	M3V
ADM1813-5ARTZ-RL	-40°C to +105°C	4.62 V	RT-3 (SOT-23)	M6X
ADM1813-5ARTZ-RL7	-40°C to +105°C	4.62 V	RT-3 (SOT-23)	M6X
ADM1813-10AKS-REEL	-40°C to +105°C	4.35 V	KS-3 (SC70)	M3T
ADM1813-10AKS-RL7	-40°C to +105°C	4.35 V	KS-3 (SC70)	M3T
ADM1813-10AKSZ-RL	-40°C to +105°C	4.35 V	KS-3 (SC70)	M6Y
ADM1813-10AKSZ-RL7	-40°C to +105°C	4.35 V	KS-3 (SC70)	M6Y
ADM1813-10ART-REEL	-40°C to +105°C	4.35 V	RT-3 (SOT-23)	M3T
ADM1813-10ART-RL7	-40°C to +105°C	4.35 V	RT-3 (SOT-23)	M3T
ADM1813-10ARTZ-RL	-40°C to +105°C	4.35 V	RT-3 (SOT-23)	M6Y
ADM1813-10ARTZ-RL7	-40°C to +105°C	4.35 V	RT-3 (SOT-23)	M6Y

Model ^{1, 2}	Temperature Range	Trip Point	Package Option	Branding
ADM1815-5AKS-RL7	-40°C to +105°C	3.06 V	KS-3 (SC70)	M5K
ADM1815-5AKSZ-REEL	-40°C to +105°C	3.06 V	KS-3 (SC70)	M73
ADM1815-5AKSZ-RL7	-40°C to +105°C	3.06 V	KS-3 (SC70)	M73
ADM1815-5ART-REEL7	-40°C to +105°C	3.06 V	RT-3 (SOT-23)	M5K
ADM1815-5ARTZ-REEL	-40°C to +105°C	3.06 V	RT-3 (SOT-23)	M73
ADM1815-5ARTZ-RL7	-40°C to +105°C	3.06 V	RT-3 (SOT-23)	M73
ADM1815-10AKS-RL7	-40°C to +105°C	2.88 V	KS-3 (SC70)	M5E
ADM1815-10AKSZ-RL	-40°C to +105°C	2.88 V	KS-3 (SC70)	M4F
ADM1815-10AKSZ-RL7	-40°C to +105°C	2.88 V	KS-3 (SC70)	M4F
ADM1815-10ART-REEL	-40°C to +105°C	2.88 V	RT-3 (SOT-23)	M5E
ADM1815-10ART-RL7	-40°C to +105°C	2.88 V	RT-3 (SOT-23)	M5E
ADM1815-10ARTZ-RL	-40°C to +105°C	2.88 V	RT-3 (SOT-23)	M4F
ADM1815-10ARTZ-RL7	-40°C to +105°C	2.88 V	RT-3 (SOT-23)	M4F
ADM1815-20AKSZ-RL	-40°C to +105°C	2.55 V	KS-3 (SC70)	M76
ADM1815-20AKSZ-RL7	-40°C to +105°C	2.55 V	KS-3 (SC70)	M76
ADM1815-20ART-RL7	-40°C to +105°C	2.55 V	RT-3 (SOT-23)	M5A
ADM1815-20ARTZ-RL7	-40°C to +105°C	2.55 V	RT-3 (SOT-23)	M76
ADM1815-R22AKSZ-RL	-40°C to +105°C	2.18 V	KS-3 (SC70)	M74
ADM1815-R22AKSZ-R7	-40°C to +105°C	2.18 V	KS-3 (SC70)	M74
ADM1815-R22ART-RL7	-40°C to +105°C	2.18 V	RT-3 (SOT-23)	M5B
ADM1815-R22ARTZ-RL	-40°C to +105°C	2.18 V	RT-3 (SOT-23)	M74
ADM1815-R22ARTZ-R7	-40°C to +105°C	2.18 V	RT-3 (SOT-23)	M74
ADM1815-R23AKSZ-RL	-40°C to +105°C	2.31 V	KS-3 (SC70)	M75
ADM1815-R23AKSZ-R7	-40°C to +105°C	2.31 V	KS-3 (SC70)	M75
ADM1815-R23ART-RL7	-40°C to +105°C	2.31 V	RT-3 (SOT-23)	M5C
ADM1815-R23ARTZ-RL	-40°C to +105°C	2.31 V	RT-3 (SOT-23)	M75
ADM1815-R23ARTZ-R7	-40°C to +105°C	2.31 V	RT-3 (SOT-23)	M75
ADM1816-5AKS-REEL7	-40°C to +105°C	3.06 V	KS-3 (SC70)	M6K
ADM1816-5AKSZ-REEL	-40°C to +105°C	3.06 V	KS-3 (SC70)	M77
ADM1816-5AKSZ-RL7	-40°C to +105°C	3.06 V	KS-3 (SC70)	M77
ADM1816-5ART-REEL7	-40°C to +105°C	3.06 V	RT-3 (SOT-23)	M6K
ADM1816-5ARTZ-REEL	-40°C to +105°C	3.06 V	RT-3 (SOT-23)	M77
ADM1816-5ARTZ-RL7	-40°C to +105°C	3.06 V	RT-3 (SOT-23)	M77
ADM1816-10AKSZ-RL	-40°C to +105°C	2.88 V	KS-3 (SC70)	M54
ADM1816-10AKSZ-RL7	-40°C to +105°C	2.88 V	KS-3 (SC70)	M54
ADM1816-10ART-REEL	-40°C to +105°C	2.88 V	RT-3 (SOT-23)	M6E
ADM1816-10ART-RL7	-40°C to +105°C	2.88 V	RT-3 (SOT-23)	M6E
ADM1816-10ARTZ-RL	-40°C to +105°C	2.88 V	RT-3 (SOT-23)	M54
ADM1816-10ARTZ-RL7	-40°C to +105°C	2.88 V	RT-3 (SOT-23)	M54
ADM1816-20AKS-RL7	-40°C to +105°C	2.55 V	KS-3 (SC70)	M6A
ADM1816-20AKSZ-RL	-40°C to +105°C	2.55 V	KS-3 (SC70)	M6H
ADM1816-20AKSZ-RL7	-40°C to +105°C	2.55 V	KS-3 (SC70)	M6H
ADM1816-20ART-RL7	-40°C to +105°C	2.55 V	RT-3 (SOT-23)	M6A
ADM1816-20ARTZ-RL	-40°C to +105°C	2.55 V	RT-3 (SOT-23)	M6H
ADM1816-20ARTZ-RL7	-40°C to +105°C	2.55 V	RT-3 (SOT-23)	M6H

Model ^{1, 2}	Temperature Range	Trip Point	Package Option	Branding
ADM1816-R22AKS-RL7	-40°C to +105°C	2.18 V	KS-3 (SC70)	M6B
ADM1816-R22AKSZ-RL	-40°C to +105°C	2.18 V	KS-3 (SC70)	M78
ADM1816-R22AKSZ-R7	-40°C to +105°C	2.18 V	KS-3 (SC70)	M78
ADM1816-R22ART-RL7	-40°C to +105°C	2.18 V	RT-3 (SOT-23)	M6B
ADM1816-R22ARTZ-RL	-40°C to +105°C	2.18 V	RT-3 (SOT-23)	M78
ADM1816-R22ARTZ-R7	-40°C to +105°C	2.18 V	RT-3 (SOT-23)	M78
ADM1816-R23AKSZ-RL	-40°C to +105°C	2.31 V	KS-3 (SC70)	M79
ADM1816-R23AKSZ-R7	-40°C to +105°C	2.31 V	KS-3 (SC70)	M79
ADM1816-R23ART-RL7	-40°C to +105°C	2.31 V	RT-3 (SOT-23)	M6C
ADM1816-R23ARTZ-RL	-40°C to +105°C	2.31 V	RT-3 (SOT-23)	M79
ADM1816-R23ARTZ-R7	-40°C to +105°C	2.31 V	RT-3 (SOT-23)	M79
ADM1817-5AKSZ-REEL	-40°C to +105°C	3.06 V	KS-3 (SC70)	M7F
ADM1817-5AKSZ-RL7	-40°C to +105°C	3.06 V	KS-3 (SC70)	M7F
ADM1817-5ART-REEL7	-40°C to +105°C	3.06 V	RT-3 (SOT-23)	M7K
ADM1817-5ARTZ-REEL	-40°C to +105°C	3.06 V	RT-3 (SOT-23)	M7F
ADM1817-5ARTZ-RL7	-40°C to +105°C	3.06 V	RT-3 (SOT-23)	M7F
ADM1817-10AKS-RL7	-40°C to +105°C	2.88 V	KS-3 (SC70)	M7E
ADM1817-10AKSZ-RL	-40°C to +105°C	2.88 V	KS-3 (SC70)	M7G
ADM1817-10AKSZ-RL7	-40°C to +105°C	2.88 V	KS-3 (SC70)	M7G
ADM1817-10ART-REEL	-40°C to +105°C	2.88 V	RT-3 (SOT-23)	M7E
ADM1817-10ART-RL7	-40°C to +105°C	2.88 V	RT-3 (SOT-23)	M7E
ADM1817-10ARTZ-RL	-40°C to +105°C	2.88 V	RT-3 (SOT-23)	M7G
ADM1817-10ARTZ-RL7	-40°C to +105°C	2.88 V	RT-3 (SOT-23)	M7G
ADM1817-20AKSZ-RL	-40°C to +105°C	2.55 V	KS-3 (SC70)	M7H
ADM1817-20AKSZ-RL7	-40°C to +105°C	2.55 V	KS-3 (SC70)	M7H
ADM1817-20ART-RL7	-40°C to +105°C	2.55 V	RT-3 (SOT-23)	M7A
ADM1817-20ARTZ-RL	-40°C to +105°C	2.55 V	RT-3 (SOT-23)	M7H
ADM1817-20ARTZ-RL7	-40°C to +105°C	2.55 V	RT-3 (SOT-23)	M7H
ADM1817-R22AKSZ-RL	-40°C to +105°C	2.18 V	KS-3 (SC70)	M7J
ADM1817-R22AKSZ-R7	-40°C to +105°C	2.18 V	KS-3 (SC70)	M7J
ADM1817-R22ART-RL7	-40°C to +105°C	2.18 V	RT-3 (SOT-23)	M7B
ADM1817-R22ARTZ-RL	-40°C to +105°C	2.18 V	RT-3 (SOT-23)	M7J
ADM1817-R22ARTZ-R7	-40°C to +105°C	2.18 V	RT-3 (SOT-23)	M7J
ADM1817-R23AKSZ-RL	-40°C to +105°C	2.31 V	KS-3 (SC70)	M7L
ADM1817-R23AKSZ-R7	-40°C to +105°C	2.31 V	KS-3 (SC70)	M7L
ADM1817-R23ART-RL7	-40°C to +105°C	2.31 V	RT-3 (SOT-23)	M7C
ADM1817-R23ARTZ-RL	-40°C to +105°C	2.31 V	RT-3 (SOT-23)	M7L
ADM1817-R23ARTZ-R7	-40°C to +105°C	2.31 V	RT-3 (SOT-23)	M7L
ADM1818-5AKS-REEL	-40°C to +105°C	3.06 V	KS-3 (SC70)	M8K
ADM1818-5AKSZ-RL7	-40°C to +105°C	3.06 V	KS-3 (SC70)	M4T
ADM1818-5ART-REEL7	-40°C to +105°C	3.06 V	RT-3 (SOT-23)	M8K
ADM1818-5ARTZ-REEL	-40°C to +105°C	3.06 V	RT-3 (SOT-23)	M4T
ADM1818-5ARTZ-RL7	-40°C to +105°C	3.06 V	RT-3 (SOT-23)	M4T
ADM1818-10AKS-RL7	-40°C to +105°C	2.88 V	KS-3 (SC70)	M8E
ADM1818-10AKSZ-RL	-40°C to +105°C	2.88 V	KS-3 (SC70)	M7P
ADM1818-10AKSZ-RL7	-40°C to +105°C	2.88 V	KS-3 (SC70)	M7P
ADM1818-10ART-REEL	-40°C to +105°C	2.88 V	RT-3 (SOT-23)	M8E
ADM1818-10ART-RL7	-40°C to +105°C	2.88 V	RT-3 (SOT-23)	M8E
ADM1818-10ARTZ-RL7	-40°C to +105°C	2.88 V	RT-3 (SOT-23)	M7P

Model ^{1, 2}	Temperature Range	Trip Point	Package Option	Branding
ADM1818-20AKSZ-RL	-40°C to +105°C	2.55 V	KS-3 (SC70)	M59
ADM1818-20AKSZ-RL7	-40°C to +105°C	2.55 V	KS-3 (SC70)	M59
ADM1818-20ART-REEL	-40°C to +105°C	2.55 V	RT-3 (SOT-23)	M8A
ADM1818-20ART-RL7	-40°C to +105°C	2.55 V	RT-3 (SOT-23)	M8A
ADM1818-20ARTZ-RL7	-40°C to +105°C	2.55 V	RT-3 (SOT-23)	M59
ADM1818-R22AKS-RL	-40°C to +105°C	2.18 V	KS-3 (SC70)	M8B
ADM1818-R22AKS-RL7	-40°C to +105°C	2.18 V	KS-3 (SC70)	M8B
ADM1818-R22AKSZ-RL	-40°C to +105°C	2.18 V	KS-3 (SC70)	M7M
ADM1818-R22AKSZ-R7	-40°C to +105°C	2.18 V	KS-3 (SC70)	M7M
ADM1818-R22ART-RL	-40°C to +105°C	2.18 V	RT-3 (SOT-23)	M8B
ADM1818-R22ART-RL7	-40°C to +105°C	2.18 V	RT-3 (SOT-23)	M8B
ADM1818-R23AKS-RL7	-40°C to +105°C	2.31 V	KS-3 (SC70)	M8C
ADM1818-R23AKSZ-RL	-40°C to +105°C	2.31 V	KS-3 (SC70)	M7N
ADM1818-R23AKSZ-R7	-40°C to +105°C	2.31 V	KS-3 (SC70)	M7N
ADM1818-R23ART-RL	-40°C to +105°C	2.31 V	RT-3 (SOT-23)	M8C
ADM1818-R23ART-RL7	-40°C to +105°C	2.31 V	RT-3 (SOT-23)	M8C

¹ Available only in reels.

² Z = RoHS Compliant Part.